

# CATALOG J

GENERAL RADIO CO.  
CAMBRIDGE, MASS., U. S. A.

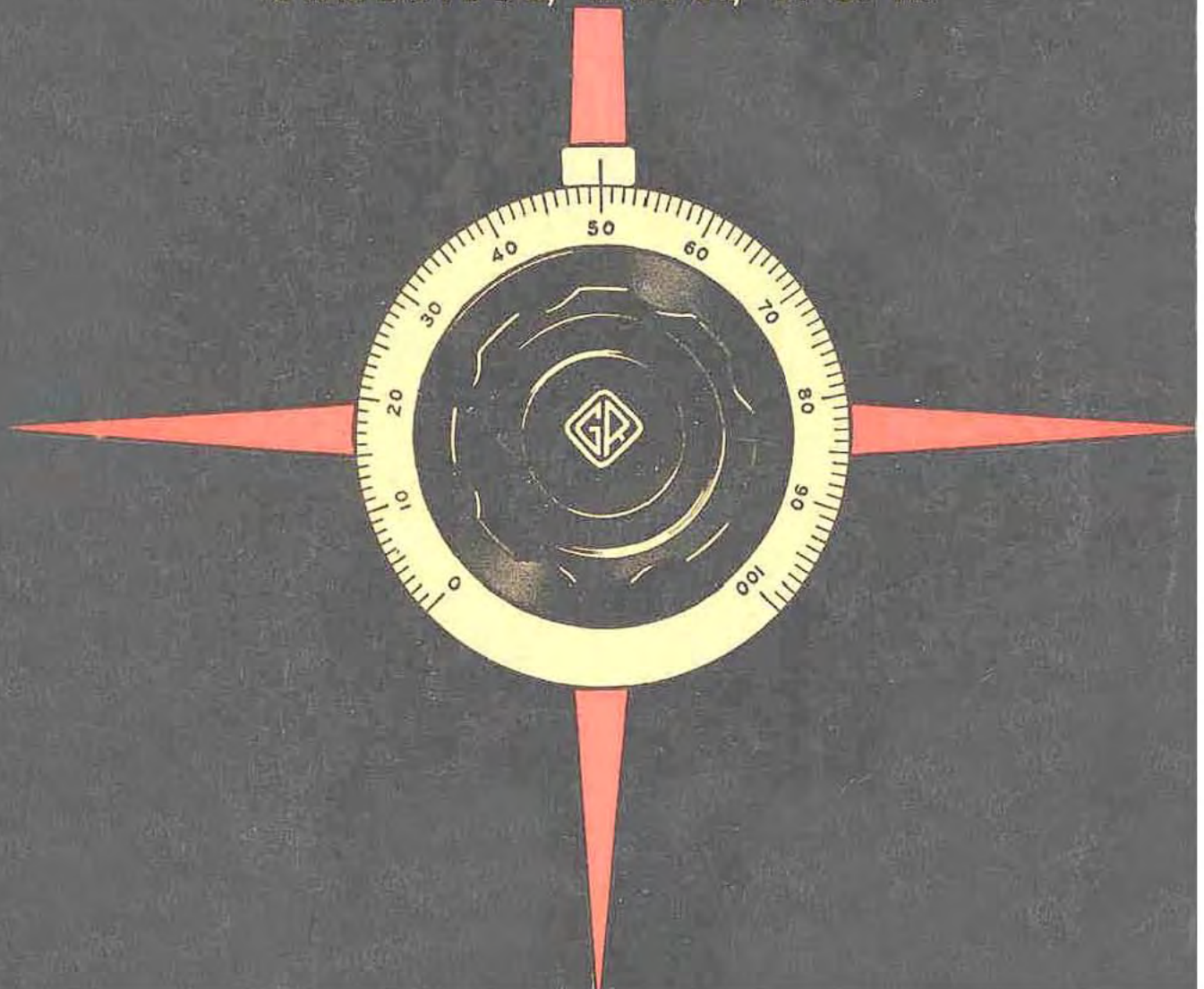

TYPICAL OPERATIONS IN MANUFACTURE OF TYPE 605-A SIGNAL GENERATOR



1 - DRAFTING



2 - ASSEMBLING EXPERIMENTAL MODEL

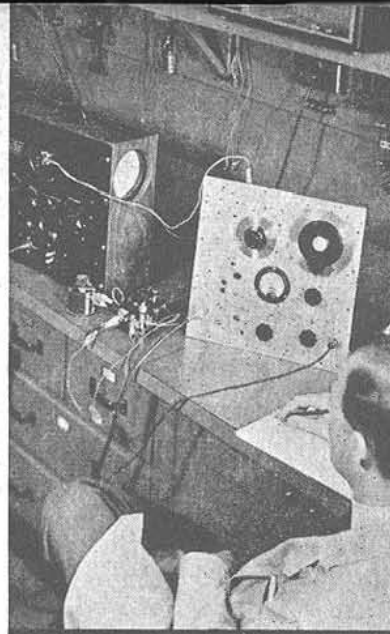

3 - ENGINEERING TEST OF EXPERIMENTAL MODEL



4 - FORMING MAIN WIRING CABLE

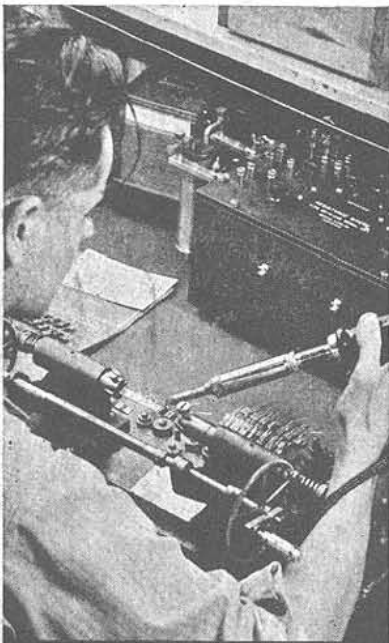

5 - WINDING ATTENUATOR RESISTANCES



6 - ASSEMBLING ATTENUATOR HOUSINGS



7 - WINDING OSCILLATOR INDUCTANCES

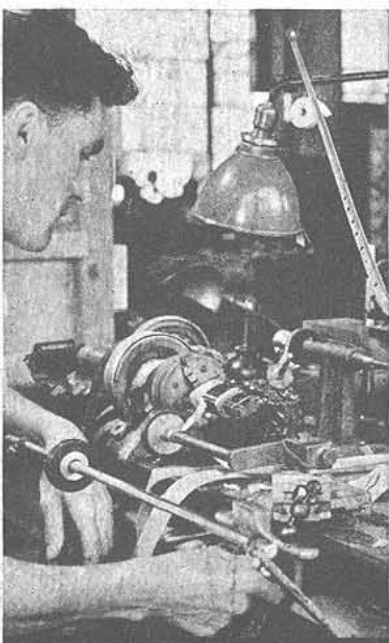

8 - WINDING POWER-TRANSFORMER COILS



9 - ASSEMBLING SLIDE-WIRE ATTENUATORS



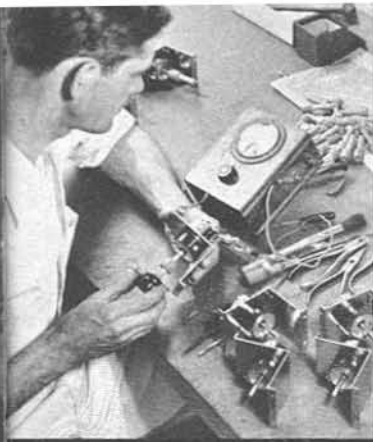

10 - TESTING SLIDE-WIRE ATTENUATORS



11 - WIRING SLIDE-WIRE ASSEMBLIES



12 - ASSEMBLING MODULATION COILS

CATALOG J



SEPTEMBER, 1936

# GENERAL RADIO COMPANY

CAMBRIDGE, MASSACHUSETTS, U. S. A.

© 1936, GENERAL RADIO COMPANY

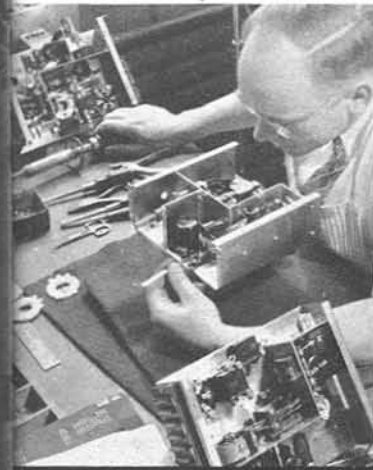

13 - WIRING AMPLIFIER SHELF ASSEMBLY

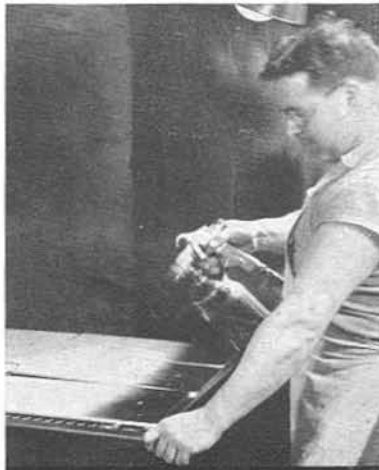

14 - FINISHING PANEL

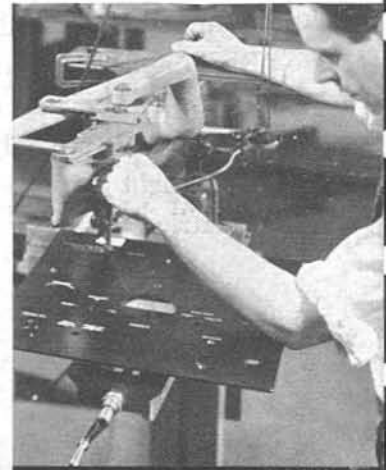

15 - ENGRAVING MAIN PANEL



16 - FORMING OSCILLATOR SHELF ENDS



17 - INSPECTING SWITCH CONTACTS



18 - ASSEMBLING FREQUENCY-CHANGE SWITCHES

OTHER MANUFACTURING PICTURES ON INSIDE BACK COVER

v

1

11

29

41

43

61

71

75

95

101

115

123

125

161

169

171

# WE SELL DIRECT . . .

## A STATEMENT OF POLICY

To develop the type of product manufactured by the General Radio Company requires a large staff of engineers, each a specialist in one or more phases of the work involved. One of the functions of this staff is to assist the customer in the selection of instruments in order that the correct equipment may be purchased with a minimum expenditure.

There has always been an intimate contact between our engineers and customers. The technical nature and the manifold uses of our product make the maintenance of this contact essential. For this reason, the General Radio Company maintains no sales agencies in the United States, but distributes its products directly to the consumer on a net, no discount, basis.

In order that customers outside the United States may receive equivalent technical service, exclusive agencies have been appointed in many foreign countries, each capable of giving technical information regarding General Radio products. In all matters regarding General Radio apparatus the customer should communicate with the agent from whom this catalog was received. Prices listed in the catalog are for domestic use only. Costs in foreign countries, where import duty and freight must be added, can be obtained from the agents in those countries.

### GENERAL RADIO COMPANY





# QUICK INDEX

HOW TO ORDER . . . . .	v
INDUSTRIAL DEVICES . . . . .	1
RESISTORS . . . . .	11
CONDENSERS . . . . .	29
INDUCTORS . . . . .	41
FREQUENCY- AND TIME-MEASURING DEVICES . . . . .	43
OSCILLATORS . . . . .	61
AMPLIFIERS . . . . .	71
BRIDGES AND ACCESSORIES . . . . .	75
STANDARD-SIGNAL GENERATORS . . . . .	95
OSCILLOGRAPHS, CAMERAS, AND ANALYZERS . . . . .	101
METERS . . . . .	115
POWER SUPPLIES . . . . .	123
PARTS AND ACCESSORIES . . . . .	125
APPENDIX AND DATA TABLES . . . . .	161
INDEX BY TYPE NUMBER . . . . .	169
INDEX BY TITLE . . . . .	171

## SUGGESTIONS FOR ORDERING

### ORDER BY TYPE NUMBER

Always order by catalog type number and whenever possible mention ranges or other significant specifications as protection against misunderstanding.

Be sure to include orders for any accessories desired or for calibrations which must be made before shipment.

### SHIPPING INSTRUCTIONS

Unless specific instructions accompany the order we shall use our best judgment as to the method of shipment.

All prices are F.O.B. Cambridge, Massachusetts. There is no domestic packing charge and no charge for shipping cases.

### TERMS

Net 30 days. Unless credit has already been established we make all shipments C.O.D.

When cash accompanies the order, we pay transportation charges to any point in the continental United States (except Alaska).

### REMITTANCES

Should be made payable at par in Boston or New York funds.

### QUANTITY DISCOUNTS

When 10 or more identical items are ordered at the same time for a single shipment, the following quantity discounts are allowed:

10-19.....	5 per cent
20-99.....	10 per cent
100 or more.....	Special discounts quoted on request.

The above discounts also apply to quantities of packages where the unit of sale is a package of small parts.

### NO TRADE OR EDUCATIONAL DISCOUNTS

Our prices are made on a direct-to-consumer basis which permits of no discounts except cash and quantity discounts.

### PRICE CHANGES

All prices are subject to change without

notice. Formal quotations remain open for 30 days.

### SPECIFICATIONS

We reserve the right to change specifications at any time without incurring any obligation to incorporate new features in instruments previously sold.

### TAXES

Since the apparatus and parts furnished by us are not subject to the manufacturers' excise tax imposed on certain radio items under Section 607 of Title IV of the Revenue Act of 1932, no tax has been included in the price. If any of these component parts are used by a "manufacturer, producer, or importer" and in a taxable manner, as defined in this Revenue Act, such "manufacturer, producer, or importer" must see that the requisite tax is paid on them. Tubes on which a tax is payable have had this tax paid and the prices given include this tax. Prices are subject to such additions for state or local taxes as we are now or may be required to collect, and to revision as to any sales or excise taxes which may hereafter be imposed and which must be included in the list price.

### SHIPMENTS TO GENERAL RADIO

When returning instruments for repair, recalibration, or for any other reason, please ask our Service Department for shipping instructions and our RETURNED APPARATUS tags.

### REPAIR PARTS

When ordering repair parts, be sure to describe carefully the parts required and give the type number and serial number from the panel of the instrument.

### TELEGRAPH AND CABLE ORDERS

We have direct telegraph printer connections with Postal and Western Union for the prompt handling of messages.

Use Bentley's code and the code words



accompanying each catalog description. Our cable address is GENRADCO BOSTON.

#### SALES AGENCIES

With the exception of a stock of parts for local distribution in New York City carried by Leeds Radio Company of 45 Vesey Street, our instruments are not sold by dealers or brokers.

#### NEW YORK ENGINEERING OFFICE

An engineering office is maintained at 90 West Street, New York City, where technical information regarding our apparatus may be obtained by those who find it more convenient to telephone or call at that office than at Cambridge. No stock is held at the New York office.

Sales offices are maintained on the Pacific Coast at 274 Brannan Street, San Francisco, and at 555 South Flower Street, Los Angeles. Small stocks are maintained at these locations.

Although our domestic sales are made on a direct-to-the-consumer basis, we have arranged with numerous foreign agents for the distribution of our products outside of the United States.

#### WARRANTY

We warrant each new instrument manufactured and/or sold by us to be free from defects in material, workmanship, and design; our obligation under this warranty being limited to repairing or replacing any instrument or part thereof which shall, within one year after delivery to the original purchaser, prove by our examination to be thus defective.

#### OTHER GENERAL RADIO PUBLICATIONS

In addition to this catalog we publish a monthly magazine, the *General Radio Experimenter*, for free distribution among interested persons. It contains technical and semi-technical engineering articles which are contributed, for the most part, by our engineering staff. To be placed on the mailing list, simply address a request to us containing your name, mailing address, and business affiliation.

## PATENTS

Many of our products are manufactured and sold under United States Letters Patent owned by the General Radio Company or under license grants from other companies. To simplify the listing of these patents they are given here in a single list and referred to at each instrument only by appropriate reference number.

1. Vacuum-tube amplifier devices, electrical wave filters, and vacuum-tube oscillators are licensed by Electrical Research Products, Inc., under all United States Letters Patent owned or controlled by American Telephone and Telegraph Company, or Western Electric Company, Inc., and any or all other United States patents with respect to which Electrical Research Products, Inc., has the right to grant a license, solely for utilization in research, investigation, measurement, testing, instruction, and development work in pure and applied science, including engineering and industrial fields.

2. Patent 1,871,886.
3. Patent 1,542,995.
4. Patent 1,707,594.
5. Patent 1,901,343.
6. Patent 1,901,344.
7. Patent 1,944,315.
8. Patent 1,967,185.
9. Patent applied for.
10. Patent 1,525,778.
11. Patent 2,009,013.

12. Licensed under all patents and patent applications of Dr. G. W. Pierce pertaining to piezo-electric crystals and their associated circuits.

13. Licensed under Hazeltine and Latour Designs and Patents for scientific measurement and test purposes only.

14. Patents 1,931,530; 1,943,302; 1,955,739.

15. Licensed under designs and patent applications of Dr. Harold E. Edgerton and Mr. Kenneth Germeshausen.

16. Patent 1,790,153 and other patents, covering electrical discharge devices and circuits with which said devices may be used, owned by the General Electric Company or under which it may grant licenses.

17. Patents 1,713,146 and 1,744,675.

18. Patent 1,983,447.

19. Patent 1,967,184.

20. Patent 2,012,497.

21. Patent 2,012,201.

22. Patent 1,999,869.

23. Licensed under designs and patent applications of Barss, Knobel, and Young, Inc.

24. Licensed under designs and patent applications of Dr. Frederick V. Hunt.

25. Patent No. 1,983,657.

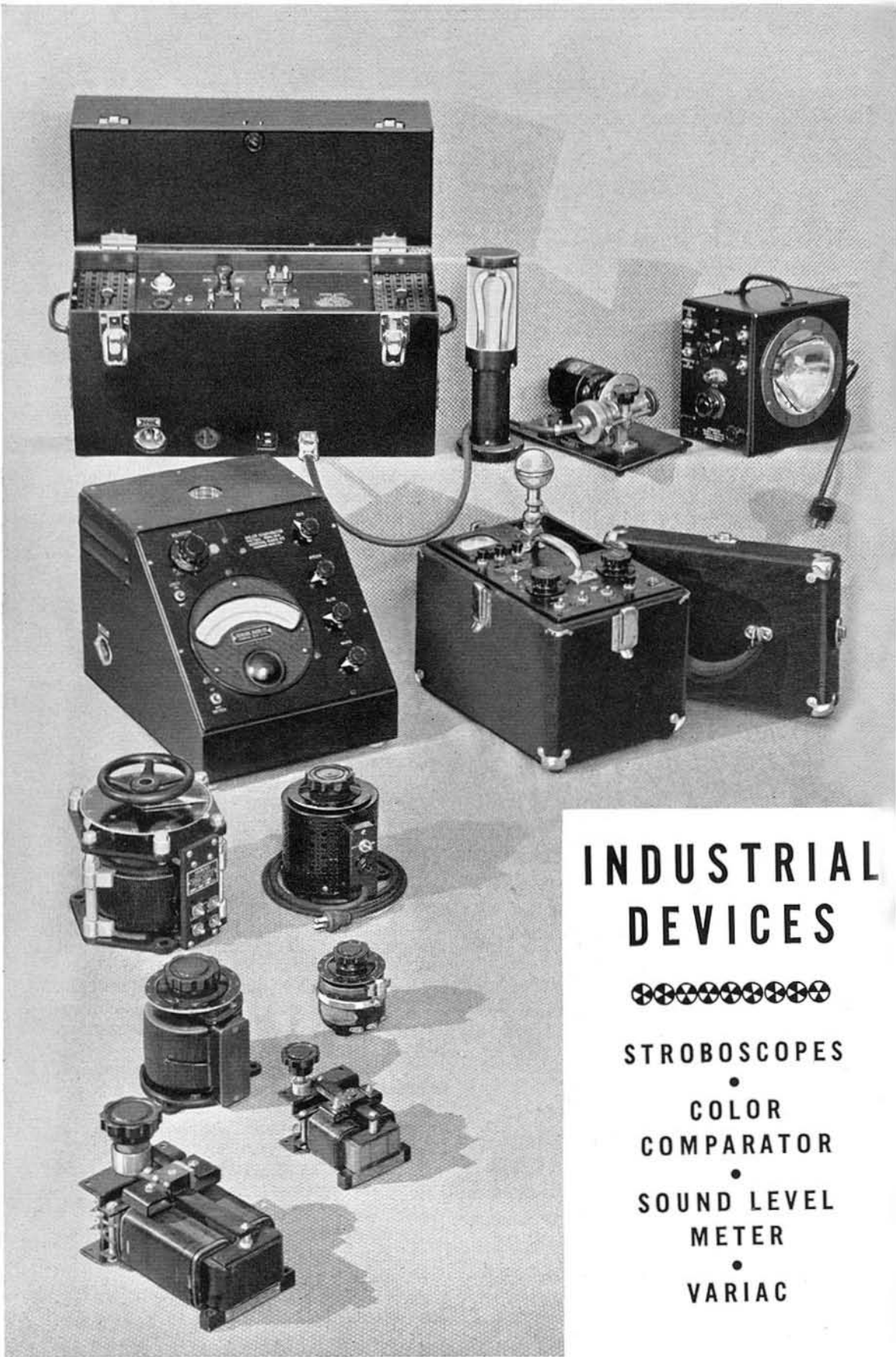

## INDUSTRIAL DEVICES



STROBOSCOPES

•  
COLOR  
COMPARATOR

•  
SOUND LEVEL  
METER

•  
VARIAC



## TYPE 548-B EDGERTON STROBOSCOPE

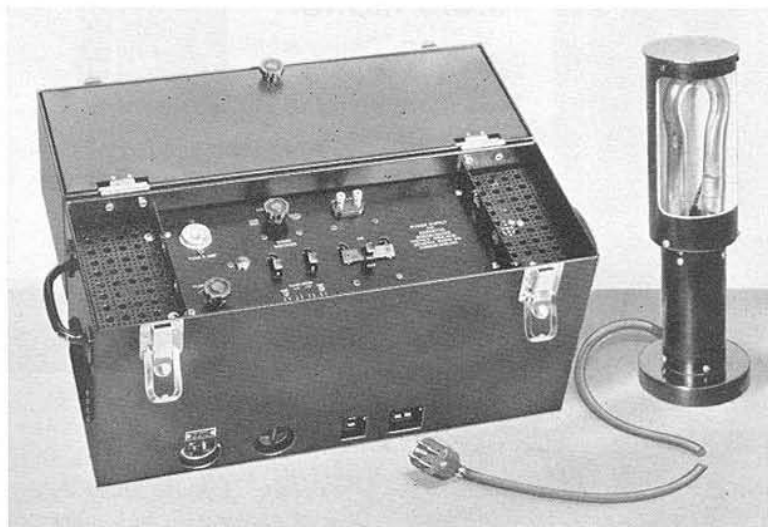

TYPE 548-B Edgerton Stroboscope (power supply and lamp)

Vision, the ability to see what is happening, is a proverbial preliminary to finding a solution for difficulties. Most modern mechanical operations have not been subject to this fundamental method of analysis because they take place at speeds too high for the eye to follow.

The stroboscope, however, depending upon the principles of intermittent viewing and retention of vision, makes this possible. If a rotating object is instantaneously viewed at only one point in its motion, the optical impression is of a stationary object. If the viewing point of successive observations progresses smoothly, the optical impression is that of an object rotating slowly at the rate of progression of the viewing point.

The Edgerton Stroboscope greatly simplifies the mechanics of the stroboscopic principle. Instead of using rotating discs, shutters, or other mechanical means, intermittent viewing is accomplished by flashing a light of high intensity and very brief duration. This stroboscope consists of a lamp, power source, and means for accurately timing the flash. The flash is of sufficient intensity to override moderate background illumination, and its duration is so brief that sharply defined views of objects moving at high linear velocities are obtained.

The stroboscope may be used as a light source in the photography of rapidly moving mechanisms. In this application it is used with a shutterless camera (such as the TYPE 651-A-E Assembly) in which the exposure is obtained by means of the brilliant flash instead of a shutter.

While the normal means for controlling the flash rate is the TYPE 549-B Synchronous-Motor Contactor, the rate can also be controlled (1) by closing any pair of electrical contacts, (2) by the 60-cycle supply mains (sixty flashes per second), or (3) by any external source of alternating current capable of maintaining 100 volts across 5000 ohms.

All parts of the stroboscope equipment except the lamp and tripping contacts are built into the metal cabinet which constitutes the power-supply unit. The cover stores the detachable mercury-vapor lamp and a TYPE 549-B Synchronous-Motor Variable-Speed Contactor which is optional equipment and is not included in the price of the instrument.

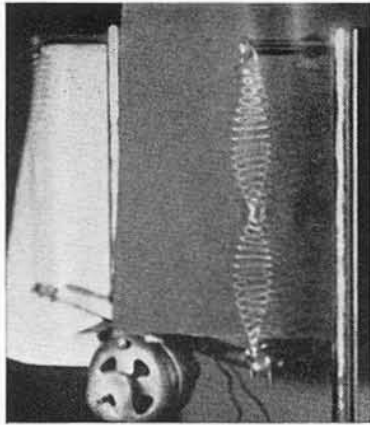

THE STROBOSCOPE  
STOPS MOTION

Two views of the same  
oscillating spring

BY ORDINARY LIGHT



BY  
STROBOSCOPE LIGHT



from unretouched sections of  
35-mm motion-picture film

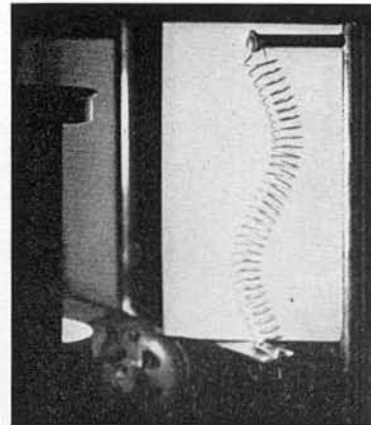

SPECIFICATIONS

**Flashing Range:** From 0 to 15,000 flashes per minute for fundamental synchronism.

**Lamp:** U-shaped mercury-vapor lamp mounted in a bakelite protective housing which may be stood upright or held in the operator's hand.

**Illumination:** The light intensity will permit good visual observations in a semi-darkened room with the lamp several feet from the object.

**Tubes:** One FG-17 thyratron and two 8S-type rectifier tubes are supplied with the instrument.

**Power Supply:** 115 volts, 50-60 cycles.

**Power Consumption:** 0.3 kw., maximum.

**Mounting:** The power supply is housed in a metal cabinet having a detachable cover in which the lamp, motor-driven contactor, and cables may be stored.

**Dimensions:** (Length) 23 x (width) 7½ x (height) 16½ inches, over-all, with cover closed. Dimensions of lamp housing, (height) 12 x (diameter) 4 inches.

**Net Weight:** 56 pounds, including lamp but not the TYPE 549-B Synchronous-Motor Contactor.

Type	Code Word	Price
*548-B	MAGIC	\$290.00

\*Includes lamp assembly. Hand contactor or synchronous-motor contactor must be ordered separately.

TUBE REPLACEMENTS

Type	Description	Code Word	Price
550-P1	Lamp	MAJOR	\$15.00
FG-17	Thyratron		10.00

PATENT NOTICE. See Notes 15 and 16, page v.

TYPE 621 EDGERTON POWER STROBOSCOPES



The power strobe scope supplies much greater illumination than does the TYPE 548 instrument. It is intended for visual use where a larger field must be illuminated or where very high flashing speeds are necessary, and for taking high speed motion pictures.

In conjunction with the TYPE 651-A-M Camera Assembly, motion pictures can be taken at a maximum speed of 2000 per second, permitting the examination of the motion of mechanical systems not previously observable by any method. Specifications and prices will gladly be sent on request.



## TYPE 631-A STROBOTAC

The General Radio Strobotac is a small portable stroboscope calibrated to read directly in revolutions per minute. Although designed primarily for speed measurement, it can also be used for the stroboscopic observation of rapidly-moving mechanisms.

Illumination is furnished by a neon lamp mounted in a reflector which focuses the light at a distance of approximately eight inches from the instrument. The flashing speed is adjusted by means of an illuminated dial which is calibrated between 600 and 14,400 r.p.m. By using multiple synchronisms, speeds up to 72,000 r.p.m. can be measured. Between 900 and 14,400 r.p.m., the accuracy of the scale is 2 per cent. The Strobotac operates from a 115-volt, 60-cycle, a-c line and provision is made for standardizing the scale in terms of the a-c line frequency. If desired, the flashing speed can be controlled by an external contactor or by the a-c line frequency.

For routine plant maintenance work and speed measurement, as well as for laboratory investigation on small areas, the Strobotac will be found entirely satisfactory.

It is ideally suited for rapidly adjusting the speeds of a number of machines intended to operate at the same speed, as, for instance, textile spindles. Because of its small size and light weight, it can be used to observe the operation of mechanisms which cannot be reached by larger instruments.

All controls are grouped on the right-hand side of the instrument and are easily accessible when the Strobotac is held in the left hand. The entire assembly weighs only 12 pounds.



## SPECIFICATIONS

**Range:** 600 to 14,400 r.p.m. Fundamental range; speeds up to 72,000 r.p.m. can be measured by using multiple synchronisms.

**Accuracy:**  $\pm 2\%$  between 900 and 14,400 r.p.m.

**Power Supply:** 115 volts, 60 cycles.

**Power Consumption:** 25 watts.

**Vacuum Tubes:** One TYPE 631-P1 Strobotron, one 80-type and one 53-type.

**Mounting:** Metal case with carrying handle.

**Dimensions:** (Width)  $6\frac{1}{2}$  x (length) 9 x (height) 10 inches, over-all.

**Net Weight:** 12 pounds.

Type	Code Word	Price
631-A	.....	.....
631-P1	Replacement Strobotron.....	\$95.00
		6.00

PATENT NOTICE. See Note 15, page v.

TYPE 549 CONTACTORS

For Use With Edgerton Stroboscope

Two commutator-type contactors are available for controlling the flashing rate of an Edgerton Stroboscope. One is a motor-driven device having the flashing rate adjustable over a wide range. The other is for pressing against the end of a shaft, tachometer-fashion. It makes one flash for every revolution of the shaft.

The synchronous-motor contactor, TYPE 549-B, when driven from a 115-volt, 60-cycle line, is capable of flashing an Edgerton Stroboscope at any rate between 500 and 3000 flashes per minute. The contactor is driven by an 1800-r.p.m. self-starting synchronous motor. Flashing rate adjustment is made by turning the knurled handle which changes the ratio of the friction-drive mechanism. A calibrated scale gives the flashing rate in flashes per minute. Phase can be adjusted independently at the contactor head.

It should be remembered that the contactor can be used for speed measurements as high as 30,000 r.p.m. If one flash occurs for every second turn of the observed phenomenon, the effective range becomes 1000 to 6000 r.p.m.; if one flash occurs for every third turn, the effective range becomes 1500 to 9000 r.p.m.; etc.

By removing the contactor head and substituting a rubber driving tip which is supplied, a hand contactor equivalent to TYPE 549-P2 is obtained.

The uncalibrated head, fitted with rubber tip so that it can be driven from a rotating shaft, is available separately as the TYPE 549-P2 Hand Contactor. Phase can be varied by rotating the adjustable head.

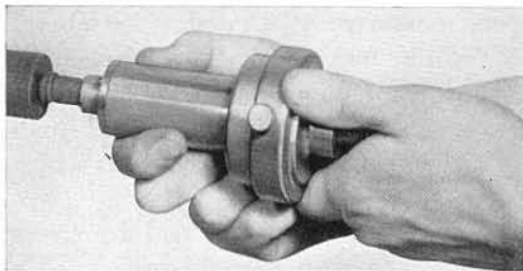

TYPE 549-P2 Hand Contactor

SPECIFICATIONS (Type 549-B)

**Range of Flashing Rate:** 500 to 3000 flashes per minute. The contactor may be used for observing and measuring speeds up to at least 30,000 r.p.m. A calibrated scale (500 to 3000 r.p.m.) is provided.

**Cords:** Connecting cords are furnished.

**Controls:** One knob for adjusting speed and the movable contactor head for adjusting the phase. Each is provided with a locking arrangement to hold it firmly in the desired position.

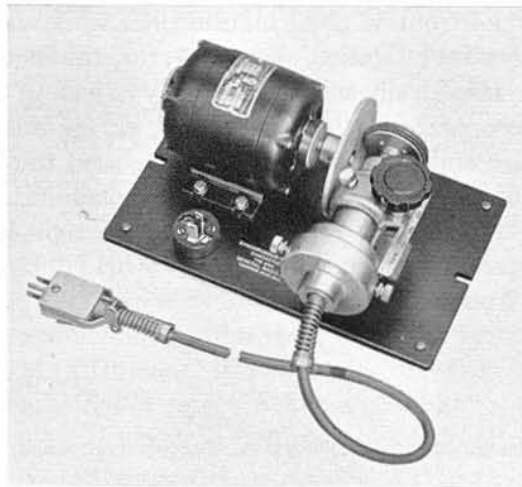

TYPE 549-B Synchronous-Motor Contactor

**Frequency Stability:** Determined by stability of the 60-cycle supply mains.

**Dimensions:** (Length) 9¾ x (width) 6¾ x (height) 4⅜ inches, over-all.

**Net Weight:** 10⅝ pounds.

Type		Code Word	Price
549-B	Motor-driven Contactor.....	MACAW	\$70.00
549-P2	Hand Contactor.....	MADAM	30.00

TYPE 725-A COLOR COMPARATOR

The General Radio Color Comparator is an instrument for comparing, in terms of spectrophotometric reflection, the color of opaque or semi-opaque objects. It can also be used to measure the opacity and brilliance of papers and similar materials. It can be used for comparing or matching dyed, printed, or painted samples. It is an extremely useful instrument for the textile paper, paint, and similar industries. It is simple, easy, and rapid to operate, giving positive and reliable results. The response approximates that of the human eye which adds considerably to its usefulness for those who are accustomed to matching colors by eye.

Since the color comparator operates entirely on the light reflected from the sample, best results are obtained on samples of relatively high reflecting power.

Because of its small size and portability it can be used directly in the plant where it is necessary to match the colors of material in process and provides, for this type of work, laboratory accuracy which has not hitherto been available.

The TYPE 725-A Color Comparator consists essentially of: (1) a light source, (2) three color filters dividing the visible spectrum into three overlapping ranges, (3) a photo-electric cell, (4) a meter for indicating the degree of reflection from the sample. An infra-red filter is used to eliminate errors due to infra-red light produced in the light source. The three filters are selected by means of a knob which is turned to bring into position the filter desired. The instrument is standardized in terms of a white Carrara glass sample whenever used.



SPECIFICATIONS

**Spectrophotometric Range:** The entire visible spectrum is covered by means of three color filters, the spectrophotometric bands of which are spaced at approximately 100 m $\mu$  intervals in the visible spectrum. The red filter is centered at approximately 650 m $\mu$ , the green at 550 m $\mu$ , and the blue at 450 m $\mu$ .

**Controls:** Power supply ON-OFF switch; filter selector control; standardizing adjustments.

**Meters:** Micro-ammeter for indicating degree of reflection.

**Power Supply:** 115-volt, 60-cycle, a-c line. A voltage regulator is included for holding the illumination to a constant value. Adequate fuse protection is provided. The total power consumption is 75 watts.

**Mounting:** The entire instrument is mounted in a black metal cabinet of rugged construction and durable finish. All controls and meters are mounted on a sloping panel at the front of the instrument.

**Dimensions:** (Width) 12 x (length) 16 x (height) 12 inches, over-all. **Net Weight:** 40 pounds.

Type	Code Word	Price
725-A	SABER	\$550.00

PATENT NOTICE. See Note 23, page v.



## TYPE 759-A SOUND LEVEL METER

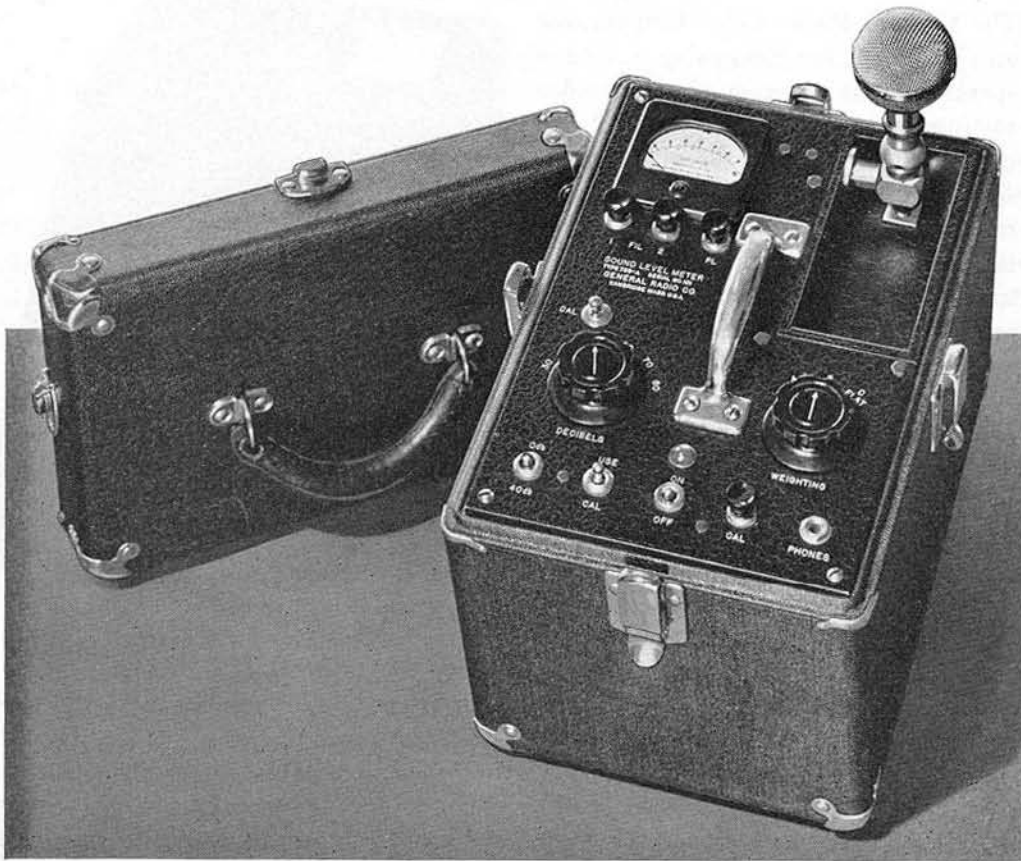

This instrument was designed to meet the demand for an inexpensive sound level meter complying with the tentative standards of the American Standards Association, the American Institute of Electrical Engineers, and the Acoustical Society of America. It incorporates several features previously found only in more expensive and cumbersome instruments and is suitable for practically all types of commercial sound level measurements. Among the features of the new noise meter are the following:

1. A non-directional crystal microphone which responds satisfactorily over a wide range of frequencies, including the high frequencies which make up "hissing" and "swishing" sounds.
2. Unusual sensitivity extending to 24 decibels above a zero reference level of  $10^{-16}$  watts per square centimeter.
3. Three separate weighting networks for adjusting the frequency response characteristics, consisting of a low level network, a high level network, and a network giving a substantially flat over-all response.
4. No rheostats or other battery adjustments.
5. Unusually light weight and small size.
6. Special tube suspension, providing a freedom from microphonic noises.
7. No inductance coils or transformers whatsoever are used in the instrument, thus eliminating error due to magnetic pickup.

## SPECIFICATIONS

**Sound Level Range:** Calibrated in decibels from +24 db to +130 db above a reference level of  $10^{-16}$  watts per square centimeter. (This corresponds to a range of +17 to +123 db when referred to the average threshold of hearing [0.45 millibars] as was used in some earlier model meters.)

**Frequency Characteristics:** The frequency characteristic of the sound level meter is adjustable to follow three different curves. The first and second of these are, respectively, the 40 and 70 db equal-loudness contours modified by the differences between random and normal free-field thresholds in accordance with the tentative standard proposed by the American Standards Association. These two response curves are used, respectively, when measuring sounds of low and high intensity. The third frequency response characteristic gives a substantially equal response to all frequencies within the range of the instrument. This characteristic is used when measuring extremely high sound levels or when using the instrument with an analyzer such as the General Radio TYPE 636-A Wave Analyzer.

**Microphone:** A non-directional piezo-electric microphone is supplied with the sound level meter. The microphone mounts directly on a folding bracket on the top of the instrument and folds down out of the way when not in use. The microphone may also be removed from the bracket and used on an extension cord. The microphone is of the sound cell type, thus eliminating the irregularities of response and the variable characteristics frequently encountered in diaphragm-type piezo-electric microphones.

**Circuit:** The amplifier consists of four stages of resistance-capacitance-coupled amplification using pentode tubes followed by an output stage arranged to match the especially-designed rectifier-type meter. This combination provides a high degree of stability and minimizes change in sensitivity resulting from variations in battery voltage. The tubes are all standard types and readily available. A ballast tube is provided for maintaining constant filament current.

**Attenuators:** A 10-db-per-step attenuator precedes the third stage of amplification and provides control of the instrument up to 90 db by means of a single knob. For measurements of higher sound

levels an additional 40-db attenuator is provided. This attenuator is directly on the input of the amplifier. Since the attenuators are at low levels the possibility of errors due to amplifier non-linearity is eliminated.

**Meter:** The indicating meter has a scale which is approximately linear in decibels and which covers a range of 16 db, thus providing satisfactory and accurate interpolation between the steps of the attenuator. The ballistic characteristics of the meter match closely those of the human ear and agree with the tentative standards specified by the American Standards Association.

**Telephones:** A jack is provided on the panel for plugging in a pair of head telephones in order to listen to the sounds being measured.

**Vibration Pickup:** If desired, a piezo-electric vibration pickup may be used in place of the microphone.

**Tubes:** Five 1A4-type tubes and one 1D1-type tube are required. A complete set of tubes is supplied with the instrument.

**Batteries:** The batteries required are two Burgess No. 4FA (little 6's), or equivalent, two Burgess No. Z30P 45-volt B batteries, or equivalent, and one Burgess No. F2BP 3-volt battery, or equivalent. A compartment is provided in the case of the sound level meter for holding all batteries and connections are automatically made to the batteries when the cover of this compartment is closed. A set of batteries is included in the price of the instrument.

**Case:** The meter is built into a shielded carrying case of airplane luggage construction, covered with a durable black waterproof material and equipped with chromium-plated corners, clasps, etc. This case has been designed to combine durability with light weight and good appearance. When operating the sound level meter, the cover is ordinarily removed. An additional handle is provided on the panel of the instrument for convenience in moving it about while it is in operation.

**Dimensions:** The over-all dimensions are approximately (height)  $11\frac{1}{2}$  x (length)  $13\frac{1}{2}$  x (width)  $9\frac{1}{2}$  inches.

**Net Weight:**  $23\frac{1}{2}$  pounds, with batteries;  $17\frac{1}{2}$  pounds, without batteries.

<i>Type</i>	<i>Code Word</i>	<i>Price</i>
759-A	NOMAD	\$195.00*
Set of replacement batteries for above		4.20

\*Price includes both tubes and batteries.

PATENT NOTICE. See Notes 1, 2, page v.

## VARIAC\*

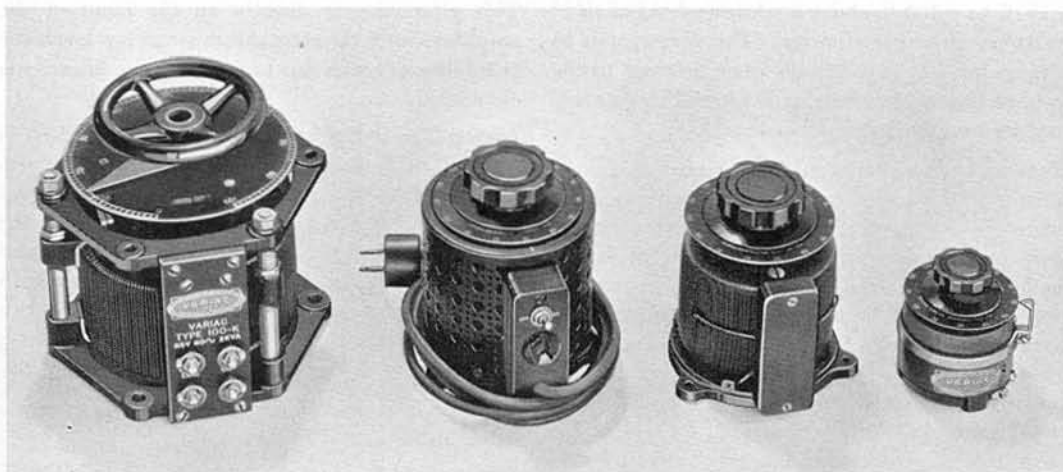

The Variac is an adjustable transformer that delivers any voltage between zero and line voltage with as smooth and uninterrupted control as that obtainable from any rheostat. (On some models any voltage between zero and 135 volts can be obtained from the 115-volt, 60-cycle line.)

The applications of the Variac to industrial control and to experimental problems in the laboratory are literally numberless. In general, it can be stated that the Variac is the ideal a-c voltage control device because of its high efficiency, low heat dissipation, and good voltage regulation. It has many advantages over the usual rheostat or potentiometer. The output voltage is essentially independent of load. Voltages in the vicinity of zero are obtainable, and it is possible to increase the voltage and thus provide a means of compensating for low line voltage.

This combination of qualities has been obtained by means of design features of considerable interest. The Variac in its simplest form consists of a laminated iron core built up of toroidal punchings. A single-layer winding traversed by a moving contact provides both the transformer effect and a convenient means of voltage adjustment. Since each turn of the winding can be reached by the contact, a continuous adjustment of voltage is obtained. The transformers are designed to have about 0.2 to 0.9 volt between turns. The carbon contact limits the current in the short-circuited turn so that no undue heating results.

Among the uses are voltage control for electrical testing, calibration and measurement work, heat control on electric furnaces, soldering irons, etc., motor speed control and illumination control in theatres, photographic studios, and dark rooms.

\*Registered in U. S. Patent Office

## SPECIFICATIONS

**Load Rating:** The value of "Load Rating" specified in the price list for each model is the full-voltage volt-ampere rating of a constant-impedance load. In other words, TYPE 100-K will control at any setting a load rated 2 kva at 115 volts.

**Current:** The "Rated Current" specified in the price list can be drawn safely at any point in the output-voltage range, but at some settings this rated value of load current may be exceeded. This increased current is the "Maximum Current" given in the price list.



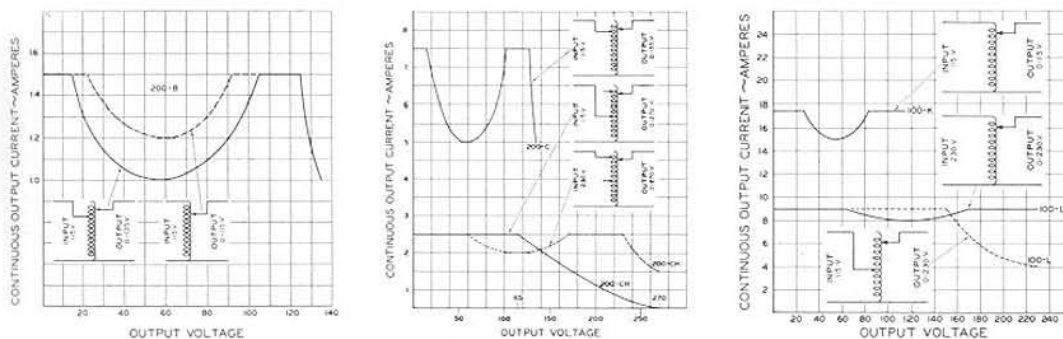

Since the Variac is an auto-transformer, maximum loss (which determines the rating) occurs at one-half line voltage. In the vicinity of full-line voltage, however, there is little transformer action, and the allowable current is limited only by heating in the brush, which permits the "Maximum Current" rating at this point.

Consequently a Variac can handle, for any setting, a constant-impedance load which draws at full voltage a current no greater than the specified "Maximum Current."

**Calibration:** Dials giving a voltage calibration accurate to  $\pm 2\%$  when the line voltage has its rated value are furnished on TYPE 200 Variacs. TYPE 100 is supplied with a 100-division dial plate which indicates percentage of line voltage.

**Knob:** TYPE 100 has a handwheel with a fixed dial plate.

TYPE 200 models have dials permanently attached to TYPE 637 Knobs.

Voltage increases with clockwise rotation of the control wheel on TYPE 100. On TYPE 200 the voltage increases with counterclockwise rotation of the dial when arranged for table mounting.

Direction of rotation for increasing voltage may be reversed by a change of connections on TYPE 200 but not on TYPE 100.

**Terminals:** TYPE 200-CM and TYPE 200-CMH are furnished complete with attachment cord and plug for the input connection to the mains, an ON-OFF

switch, and a standard plug receptacle for the output circuit.

TYPE 100, 200-B, 200-CU, and 200-CUH have threaded terminal studs with nuts and soldering lugs.

**Mounting:** All models are readily converted from the table mounting illustrated to back-of-panel mounting. TYPE 100 models can be mounted in cascade for operation by a single shaft. See accompanying drawing for mounting dimensions.

TYPE 200-CM and TYPE 200-CMH are supplied with protecting cases. All other models are supplied without a case.

**Dimensions:** See sketch. Over-all height: TYPE 100-K,  $7\frac{3}{8}$ ; TYPE 100-L, 8; TYPE 200-B, 4; and TYPES 200-C and 200-CH,  $5\frac{1}{2}$  inches.

**Net Weight:** TYPE 100-K,  $20\frac{5}{8}$  pounds; TYPE 100-L,  $23\frac{3}{4}$  pounds; TYPE 200-B,  $3\frac{3}{4}$  pounds; TYPES 200-CM and 200-CMH, 10 pounds; and TYPES 200-CU and 200-CUH, 9 pounds.

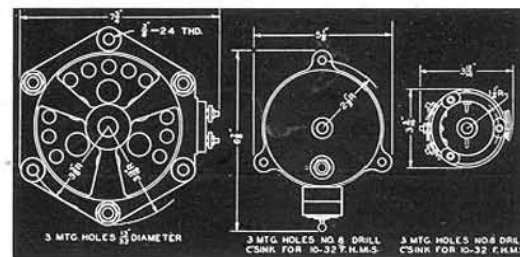

100-K, -L      200-CM, -CU      200-B  
VARIAC TYPES

Type	Load Rating	Primary Voltage	Current		Output Voltage	Code Word	Price
			Rated	Maximum			
100-K	2 kva	115 v	15 a	17.5 a	0-115 v	BEAMY	\$40.00
100-L	2 kva	230 v	8 a	9 a	0-230 v	BEARD	40.00
200-B	170 va	115 v	1 a	1.5 a	0-135 v	BALSA	10.00
200-CM	850 va	115 v	5 a	7.5 a	0-135 v	BALMY	17.50
200-CU	850 va	115 v	5 a	7.5 a	0-135 v	BAKER	14.50
200-CMH	580 va	230 v	1.5 a	2.5 a	0-270 v	BAIRN	21.50
200-CMH		115 v	0.5 a	2.5 a	0-270 v		
200-CUH	580 va	230 v	1.5 a	2.5 a	0-270 v	BAGUE	18.50
200-CUH		115 v	0.5 a	2.5 a	0-270 v		

PATENT NOTICE. See Note 11, page v.

VARIAC TRANSFORMERS

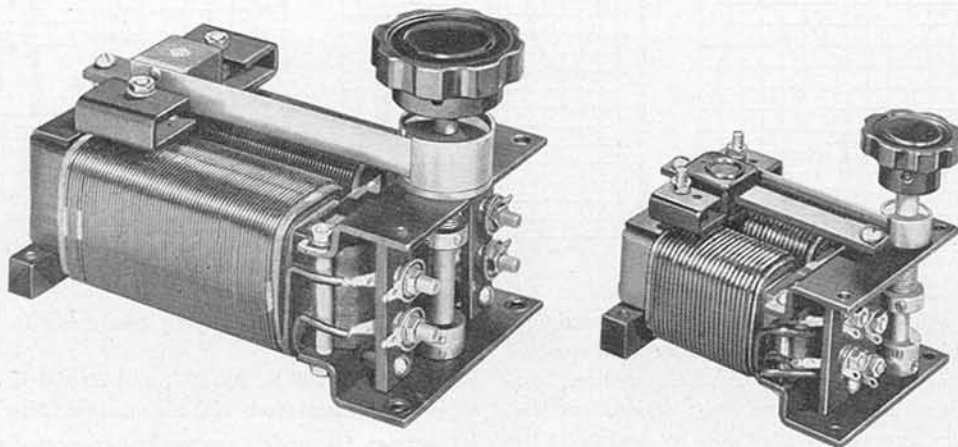

These recently developed Variac Transformers, intended for use where only small voltage variations are desired, are similar to the toroidal Variac in performance, but are radically different in design.

The new Variac Transformers are built on rectangular cores with windings in several layers on the two legs of the core. The top layers of wire are exposed to two sliding carbon contacts. These contacts are directly connected, eliminating flexible leads. By means of a steel tape, a 320-degree rotation of the control knob drives the contacts along the entire length of the windings. The windings beneath the top layer are conventional transformer coils and can be used for a number of purposes.

Four standard models are listed below. A number of different voltage-current combinations can be supplied on these cores. For good efficiency the design limitations on the special transformers are 10 amperes and a maximum voltage variation of 30 volts for the TYPE 70 core and 20 amperes and 60 volts variation for the TYPE 80 core. Within these limits special transformers can be supplied promptly and economically.

SPECIFICATIONS

Type	Line	Volts	Output	Volts	Max. Current
70-A	Constant	115	Adjustable	0-10	6 a
70-B	Fluctuating	100-125	Constant	115	2 a
80-A	Constant	115	Adjustable	0-10	20 a
80-B	Fluctuating	90-130	Constant	115	7.5 a

**Load Rating:** TYPE 70 furnishes 50 watts and TYPE 80 supplies 250 watts of variable power.

**Current:** See table above.

**No-Load Loss:** Approximately 5 watts for TYPE 70; 10 watts for TYPE 80.

**Terminals:** Threaded terminal studs with soldering lugs.

**Dimensions:** TYPE 70, (length)  $4\frac{3}{4}$  x (width)  $3\frac{3}{8}$  x (height) 4 inches; TYPE 80, (length)  $8\frac{1}{2}$  x (width)  $4\frac{1}{4}$  x (height)  $5\frac{1}{2}$  inches, over-all.

**Net Weight:** TYPE 70,  $4\frac{1}{4}$  pounds; TYPE 80,  $13\frac{1}{4}$  pounds.

Type	Code Word	Price
70-A	BASIN	\$10.00
70-B	BASSO	10.00
80-A	BATON	15.00
80-B	BATTY	15.00

PATENT NOTICE. See Note 11, page v.



# RESISTORS



- DECADE RESISTORS
- 
- RESISTANCE UNITS
- 
- ATTENUATION BOXES
- 
- VOLUME CONTROLS
- 
- RHEOSTAT-
- POTENTIOMETERS



## TYPE 602 DECADE-RESISTANCE BOX

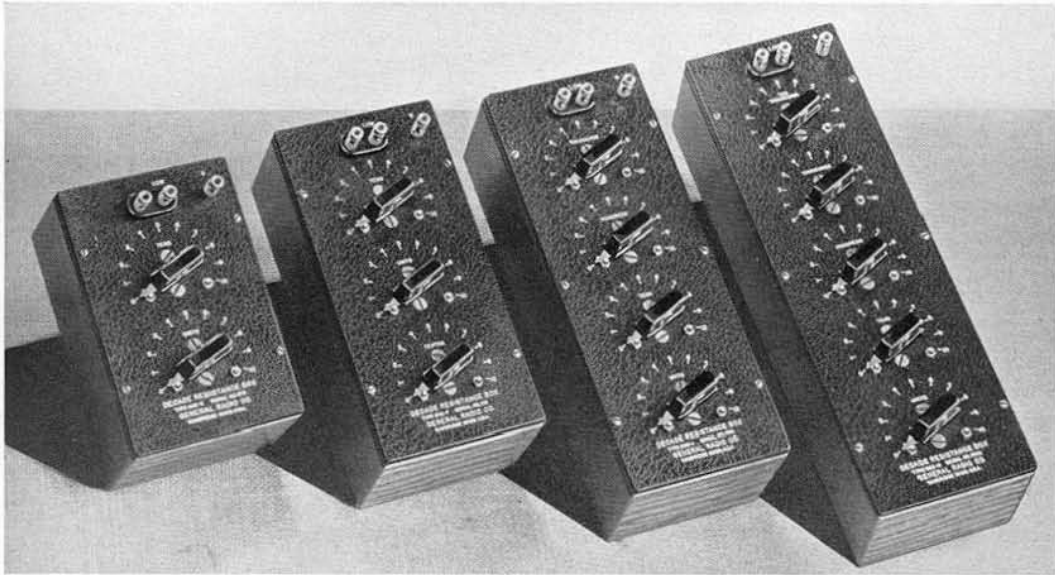

A convenient assembly of resistance cards in a single cabinet with switches is a necessary laboratory accessory wherever electrical measurements are made. Such boxes are constantly used in circuits where a wide range of resistance values is required, as laboratory standards, bridge arms, and dummy generator and load resistors.

The TYPE 602 Decade-Resistance Box is an assembly of two or more TYPE 510 Decade-Resistance Units in a single cabinet. Mechanical and electrical protection of the units is provided by the shielded walnut box and aluminum panel, which completely enclose both units and switch contacts. Two-, three-, four-, and five-dial decade assemblies are available. Each decade has eleven contact studs and ten resistance units, so that dials overlap. A detent mechanism assists in setting squarely on the contacts. This permits adjustments to be made without looking at the dials.

The resistors are adjusted to have their specified values at their own terminals and not at the terminals of the box. The resistance measured at the box terminals will, therefore, be high by the switch contact and wiring resistance, which amounts to about 0.003 ohm per dial. This method of adjustment has been adopted primarily because no method in which the switch resistance is absorbed in some one unit of a decade can give the correct value of the total resistance for all settings of the various decades. There are also many types of measurement (voltage-divider and substitution bridge measurements, for example) in which the difference in two settings of a resistance box is significant. This difference is given correctly only when the individual resistors have been adjusted independently of switch resistance. The wiring also adds a small inductance, about 0.1 microhenry per decade.

The resistance elements have no electrical connection with the shield, which is brought out to a separate terminal on the panel.

All General Radio boxes are equally useful on direct and alternating current and maintain their usefulness for many applications well into the radio-frequency range.

The frequency characteristics of the individual decades will be found under TYPE 510 Decade-Resistance Units, page 15. When several decades are assembled in a single box, the box wiring and the capacitance to shield of the individual cards will, of course, affect the frequency characteristic. These effects vary with frequency and are generally

greater for the very low and very high resistance decades. They do not appear at audio frequencies, but have an appreciable effect on resistance values at carrier and radio frequencies.

Generally speaking, the 1-, 10-, and 100-ohm dials are most satisfactory at high frequencies.

When the boxes are used in tuned circuits, only changes in resistance due to skin effect and, in some high-resistance cards, to effective capacitance need be considered. When the boxes are used as drop wires, the reactance of wiring and cards at high frequencies will affect the apparent impedance of the box. Data on these effects will be found in the specifications under "Frequency Characteristics."

### SPECIFICATIONS

**Type of Winding:** See specifications for TYPE 510 Decade-Resistance Units, page 14.

**Accuracy of Adjustment:** All cards are adjusted to within 0.1% of the stated value between card terminals, except the 1-ohm cards which are adjusted to within 0.25% and the 0.1-ohm cards which are adjusted to within 1%. Where necessary, add 0.003 ohm for each dial to allow for contact and wiring resistance.

**Frequency Characteristics:** There is no serious frequency error below 50 kc. At higher frequencies the error results from changes in resistance and the effect of the reactance in the cards, and from the inductance of the box wiring (about 0.1  $\mu$ h per dial).

For characteristics of the individual decades, see specifications for TYPE 510 Decade-Resistance Units, page 14.

**Maximum Current:** See specifications for TYPE 510 Decade-Resistance Units, page 14.

**Terminals:** Jack-top binding posts set on General Radio standard  $\frac{3}{4}$ -inch spacing for resistance con-

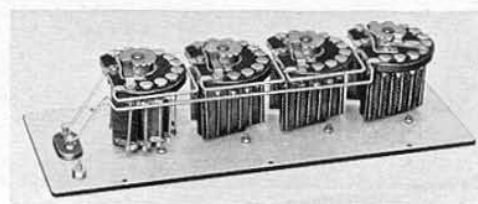

Typical internal construction of a TYPE 602 Decade-Resistance Box

nections. There is an extra post at the corner of the panel for connections to the shield.

**Mounting:** A copper-lined walnut cabinet, with aluminum panel, completely encloses switches and resistance units. The panel finish is black crackle lacquer.

**Dimensions:** Panel length depends on the number of dials (see price list), being  $7\frac{3}{4}$  for 2-dial,  $10\frac{3}{8}$  for 3-dial, 13 for 4-dial, and  $15\frac{5}{8}$  inches for 5-dial boxes. Panel width, 5 inches. Over-all height, 5 inches.

**Net Weight:**  $3\frac{1}{4}$  for 2-dial,  $4\frac{1}{4}$  for 3-dial, 5 for 4-dial, and  $6\frac{1}{4}$  pounds for 5-dial boxes.

Type	Resistance	No. of Dials	Code Word	Price
602-D	11 ohms, total, in steps of 0.1 ohm	2	DECOY	\$25.00
602-E	110 ohms, total, in steps of 1 ohm	2	DECY	25.00
602-F	111 ohms, total, in steps of 0.1 ohm	3	DELTA	35.00
602-G	1110 ohms, total, in steps of 1 ohm	3	DIGIT	35.00
602-K	1111 ohms, total, in steps of 0.1 ohm	4	DEFER	45.00
602-J	11,110 ohms, total, in steps of 1 ohm	4	DEBIT	50.00
602-N	11,111 ohms, total, in steps of 0.1 ohm	5	DEMON	62.00
602-M	111,110 ohms, total, in steps of 1 ohm	5	DEMIT	70.00
602-L	111,100 ohms, total, in steps of 10 ohms	4	DECAY	58.00

## TYPE 510 DECADE-RESISTANCE UNIT

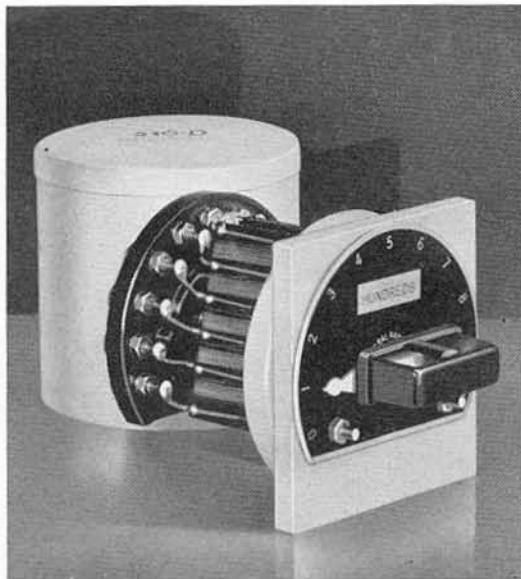

These precision decade resistors are identical with those used in the TYPE 602 Decade-Resistance Box. They are intended for assembly into either experimental or permanent equipment where only a single decade is needed or where a TYPE 602 Decade-Resistance Box cannot be conveniently mounted.

Each resistor is carefully adjusted and aged, the construction being such that there is no serious error at frequencies as high as 50 kc. Operation is equally satisfactory in d-c circuits, since manganin is used for all units except 10,000-ohm cards. Quadruple-leaf switches running over large contacts insure a low and constant contact resistance.

Each decade is enclosed in an aluminum shield, and a knob and an etched-metal dial plate are supplied. The unit is also available, complete as illustrated with shield, shield cover, blank dial plate, and switch stops, but without resistors, as the TYPE 510-P3 Switch.

A discussion of the frequency characteristics of these units is given in the *General Radio Experimenter*, Vol. VI, No. 9, February, 1932.

## SPECIFICATIONS

**Accuracy of Adjustment:** Resistors are adjusted to be accurate at card terminals within the tolerances given in Table I below.

**Maximum Current:** See Table I below.

**Type of Winding:** See Table I below.

TABLE I

Type	Resistance per Step	Accuracy	Type of Winding	Maximum Current	
				20°C. Rise	40°C. Rise
510-A	0.1 $\Omega$	$\pm 1.0\%$	Bifilar	1 a	1.5 a
510-B	1 $\Omega$	$\pm 0.25\%$	Ayrton-Perry	600 ma	1 a
510-C	10 $\Omega$	$\pm 0.1\%$	Ayrton-Perry	170 ma	250 ma
510-D	100 $\Omega$	$\pm 0.1\%$	Ayrton-Perry	50 ma	80 ma
510-E	1000 $\Omega$	$\pm 0.1\%$	Unifilar on Mica	15 ma	23 ma
510-F	10,000 $\Omega$	$\pm 0.1\%$	Unifilar on Mica	5 ma	7 ma

**Frequency Characteristics:** There is no serious error below 50 kc. At higher frequencies the error results from skin effect and reactance in the cards and leads.

Table II lists the change in resistance for each decade at maximum setting as a function of frequency.

Table III lists the change in impedance for each decade at maximum setting as a function of frequency. These values indicate the error occurring

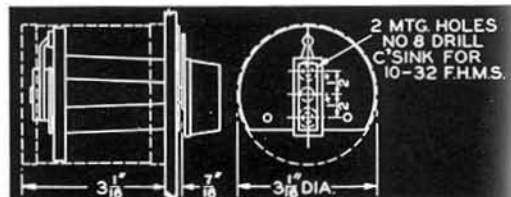



TABLE II  
Percentage Error in Resistance  
for Maximum Setting of Each Decade as a Function of Frequency

Decade	Frequency in kc						
	50	100	200	500	1000	2000	5000
0.1-ohm steps	0	0.1%	0.2%	1.5%	5%	—	—
1 -ohm steps	0	0	0.1%	0.3%	1%	4%	—
10 -ohm steps	0	0	0	0.1%	0.5%	2%	11%
100 -ohm steps	0	0	0	0.1%	0.3%	0.8%	4%
1000 -ohm steps	0	-0.1%	-0.5%	-3%	-11%	—	—
10,000 -ohm steps	-1%	-5%	—	—	—	—	—

TABLE III  
Change in Impedance (as a percentage of nominal resistance)  
for Maximum Setting of Each Decade as a Function of Frequency

Decade	Frequency in kc						
	50	100	200	500	1000	2000	5000
0.1-ohm steps	0.2%	0.7%	2%	—	—	—	—
1 -ohm steps	0.1%	0.2%	1%	5%	—	—	—
10 -ohm steps	0	0	0.1%	0.2%	2%	—	—
100 -ohm steps	0	0	0	0.1%	0.3%	1%	5%
1000 -ohm steps	0	-0.1%	-0.5%	-2%	-6%	—	—
10,000 -ohm steps	-2%	-10%	—	—	—	—	—

when the decade is used as a series circuit element or as a voltage divider. When shunted across a tuned circuit, the reactance is tuned out and the remaining error is only that owing to skin effect.

**Switches:** Quadruple-leaf, phosphor-bronze switches bear on contact studs  $\frac{3}{8}$  inch in diameter. Switch brushes are bent so as not to be tangent to the arc of travel, thus avoiding cutting. A cam-type detent is provided. There are eleven contact points (0 to 10 inclusive). The switch resistance is approximately 0.002 ohms.

**Temperature Coefficient:** The temperature coefficient of resistance is less than  $\pm 0.002\%$  per degree C. at room temperatures.

**Resistance Wire:** Manganin is used on all decades except the 10,000-ohm units, which are wound with a combination of Nichrome and Ohmax in suitable proportions to give approximately zero temperature coefficient.

**Terminals:** Soldering lugs are provided.

**Mounting:** Each decade is complete with dial plate and knob and can be mounted on any panel between  $\frac{1}{4}$  inch and  $\frac{3}{8}$  inch in thickness.

**Dimensions:** See sketch; shaft diameter is  $\frac{3}{8}$  inch.

**Net Weight:** TYPE 510 Units, 11 ounces; TYPE 510-P3,  $9\frac{1}{2}$  ounces.

Type	Resistance		Code Word	Price
	Total	Per Step		
510-A	1 $\Omega$	0.1 $\Omega$	ELATE	\$8.50
510-B	10 $\Omega$	1 $\Omega$	ELDER	8.50
510-C	100 $\Omega$	10 $\Omega$	ELEGY	8.50
510-D	1000 $\Omega$	100 $\Omega$	ELBOW	8.50
510-E	10,000 $\Omega$	1000 $\Omega$	ELECT	12.00
510-F	100,000 $\Omega$	10,000 $\Omega$	ELVAN	14.00
510-P3 Switch			ENVOY	5.00

## TYPE 670 COMPENSATED DECADE RESISTOR



The TYPE 670 Compensated Decade Resistor is a decade-resistance box having completely non-reactive resistance increments.

While the TYPE 602 Decade-Resistance Boxes have a sufficiently low reactance to be serviceable for many applications even at radio frequencies, no type of resistance box can be made entirely non-reactive. In methods of measurement requiring a variable non-reactive resistance, a pure resistance increment is sought rather than a pure resistance, that is, a residual constant inductance can be taken care of through a preliminary balance.

The TYPE 670 Compensated Decade Resistors are designed to take advantage of this fact. A double card system is used,

and the switch is so arranged that a copper coil of proper magnitude to keep the inductance constant is substituted when a resistance coil is switched out of circuit. In this way the resistance can be changed without producing any change in circuit inductance.

The constant residual inductance produced by this method is of the same magnitude as the inductance of an uncompensated box with all decades at maximum setting. The boxes are intended for use either in substitution methods, where the preliminary balance of the circuit will take care of the residual inductance, or in bridge circuits where the residual inductance can be balanced by a compensating inductance in the opposite bridge arm.

The value of these boxes is best demonstrated by the fact that it was this development which made possible the TYPE 516-C Radio-Frequency Bridge and the TYPE 667-A Inductance Bridge, both of which are described elsewhere in this catalog, and both of which require pure resistance increments in the bridge arms.

## SPECIFICATIONS

**Type of Winding:** The 10-ohm and 1-ohm steps are Ayrton-Perry-wound resistance cards. The 0.1-ohm steps are bifilar units. The decades are compensated by copper coils and a substitution switching arrangement which keep the box inductance constant at all settings as shown on page 17.

The construction of the continuously-adjustable compensated slide wire is illustrated on page 18.

**Accuracy of Adjustment:** Resistance increments are correct to within 0.1% for the 10-ohm cards, 0.25% for the 1-ohm cards, and 1% for the 0.1-ohm decade steps and the 1-ohm slide wire. The inductance is constant within 0.05  $\mu$ h.

**Maximum Current:** The upper limit of temperature rise is 40°C. Values of current for 20°C. and 40°C. rises are given in Table I.

TABLE I  
Current for Temperature Rise  
of 20°C. and 40°C.

Decade	20°C. Rise	40°C. Rise
0.1-ohm steps	900 ma	1.5 a
1 -ohm steps	300 ma	500 ma
10 -ohm steps	96 ma	160 ma

**Switches:** Double-leaf, phosphor-bronze switches bear on contact studs  $\frac{1}{4}$  inch in diameter. Switch brushes are bent so as not to be tangent to the arc of travel, thus avoiding cutting. A cam-type detent is provided. There are eleven contact points (0 to 10 inclusive).

**Frequency Characteristics:** The frequency characteristics of the TYPE 668 Decades used in these boxes are modified by the wiring and the shield of the cabinet. Shunt capacitance effects are negligible because only low values of resistance are used. The skin effect in the resistors will be increased by that in the wiring. For further details, see specifications

for TYPE 668 Compensated Decade-Resistance Units.

**Terminals:** Standard  $\frac{3}{4}$ -inch spacing is used on the terminals. A ground post connected to shield is also provided.

**Temperature Coefficient:** Less than  $\pm 0.002\%$  per degree C. at room temperature.

**Mounting:** The dials are mounted on aluminum panels in copper-lined walnut cabinets.

**Dimensions:** Panel, (length) 13 x (width) 5 inches. Cabinet, (height) 5 inches, over-all.

**Net Weight:** 5 pounds (all types).

Type	Resistance	Zero Resistance	Zero Inductance	Code Word	Price
*670-BW	0 to 11 ohms, total, with slide wire	0.050 ohm	0.70 $\mu$ h	ABRID	\$80.00
670-F	0 to 111 ohms, total, in steps of 0.1 ohm	0.045 ohm	1.05 $\mu$ h	ABYSS	65.00
*670-FW	0 to 111 ohms, total, with slide wire	0.085 ohm	1.05 $\mu$ h	ADOWN	75.00

\*Built to order only and not carried in stock. Normal delivery, two weeks.  
PATENT NOTICE. See Note 17, page v.

## TYPE 668 COMPENSATED DECADE-RESISTANCE UNIT

Although the inductance of TYPE 510 Decade-Resistance Units has been reduced to a very small value, it is still large enough to introduce errors in precise capacitance measurements at radio frequencies and inductance measurements at audio frequencies. It is impossible to build an ideal, inductance-free resistor, and the next best thing is a unit in which the inductance is kept constant.

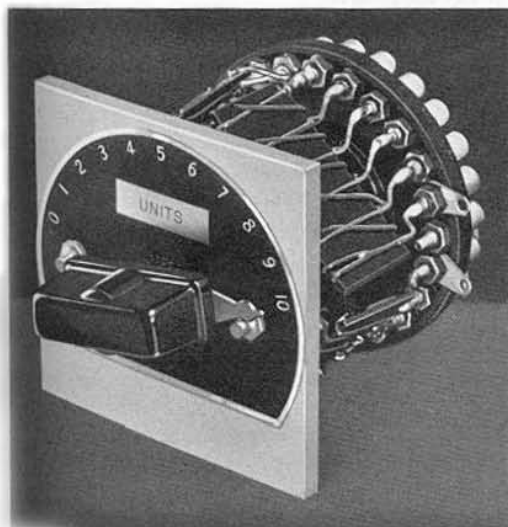

The TYPE 668 Compensated Decade-Resistance Unit is equipped with a double set of switch contacts, by means of which a copper winding is exchanged, step by step, for the resistive turns in order to keep the total inductance independent of the resistance setting. The total inductance of each unit is given in the price list.

The method of mounting is identical with that of the TYPE 510 Decade-Resistance Unit, except that no aluminum shield is provided. The three types of this unit, when mounted together or combined with TYPES 669-A or -R as a resistance box, are available as the TYPE 670 Compensated Decade Resistors.

## SPECIFICATIONS

**Type of Winding:** Same as for TYPE 510 Units.

**Switch:** A double switch, similar in construction to the single switch used with TYPE 510, is used.

**Maximum Current:** See specifications for TYPE 670 Compensated Decade Resistor, page 16.

**Accuracy of Adjustment:** For 0.1-ohm steps, 1%; for 1-ohm steps, 0.25%; for 10-ohm steps, 0.1%. Where necessary, add the value of "zero resistance" given in the price list. Inductance constant to within 0.05  $\mu$ h.

**Frequency Characteristics:** The frequency characteristics of TYPE 668 Compensated Decade-Resistance Units are similar to those of TYPE 510 Decade Resistance Units, page 15. Because ten-ohm cards are the largest used, the effects of shunt capacitance are

entirely negligible, and the change in resistance with frequency results almost entirely from skin effect.

Skin effect in the compensating winding is greater than that in the resistance cards, hence the net change in resistance with frequency for increments on the dial is negative. That is, the increment in resistance between one switch point and the next higher will be less at high frequencies than at low. This "negative skin effect" is about -0.8% for the units decade and about -0.6% for the tens decade at one megacycle. The resistance at the decade terminals, however, shows a positive skin effect.

**Mounting:** A combination dial plate and drilling template are furnished.

**Dimensions:** Diameter,  $3\frac{1}{8}$  inches; depth behind panel, 3 inches, over-all; shaft diameter,  $\frac{3}{8}$  inch.

**Net Weight:** 10 ounces.

Type	Resistance			Total L	Code Word	Price
	Total	Per Step	Zero			
668-A	1 $\Omega$	0.1 $\Omega$	0.005 $\Omega$	0.15 $\mu$ h	GABLE	\$15.00
668-B	10 $\Omega$	1.0 $\Omega$	0.020 $\Omega$	0.3 $\mu$ h	GAILY	15.00
668-C	100 $\Omega$	10.0 $\Omega$	0.015 $\Omega$	0.5 $\mu$ h	GALOP	15.00

## TYPE 669 COMPENSATED SLIDE-WIRE RESISTOR

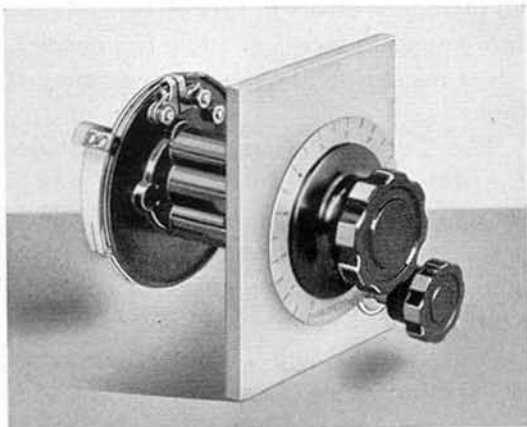

This unit is a slide wire, compensated for inductance, for use where it is desired to secure a closer adjustment of resistance than is possible with a TYPE 668 Compensated Decade-Resistance Unit.\*

\*A description of the constructional details was published in the *General Radio Experimenter*, Vol. VIII, No. 10, March, 1934.

## SPECIFICATIONS

**Maximum Current:** For 1-ohm unit, 1.6 a; for 0.1-ohm unit, 5 a.

**Accuracy of Calibration:** Each unit is fitted with a dial individually engraved at 11 points, giving the slide-wire resistance to within 1% for the 1-ohm and 5% for the 0.1-ohm units. Where necessary, add the value of "zero resistance" given in the price list. Inductance constant to within 0.005  $\mu$ h.

**Mounting:** Interchangeable with TYPE 668, except for the use of dial and slow-motion drive. A dial indicator is supplied.

**Dimensions:** Diameter,  $3\frac{1}{2}$  inches; depth behind panel, 3 inches, over-all.

**Net Weight:** 8 ounces.

Type	Resistance		Total L	Code Word	Price
	Max.	Zero			
669-A	1.15 $\Omega$	0.05 $\Omega$	0.15 $\mu$ h	GAMIN	\$25.00
669-R	0.115 $\Omega$	0.02 $\Omega$	0.15 $\mu$ h	GAZEL	25.00

PATENT NOTICE. See Note 17, page v.



## TYPE 646-A LOGARITHMIC RESISTOR

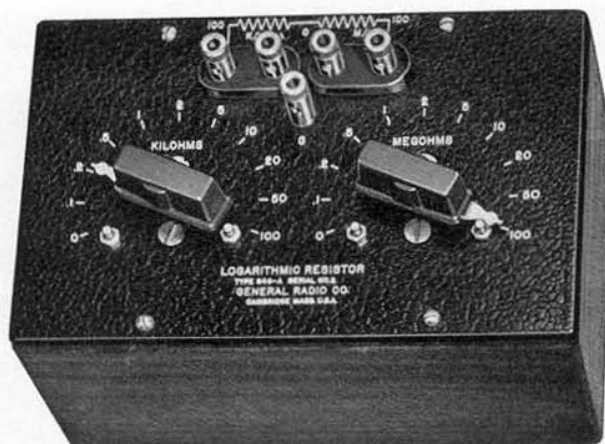

From this new logarithmic type of resistance box, a large number of known values of resistance between 0 and 100.1 megohms are available. Obtainable values are distributed in approximately logarithmic steps over this range, so that the unit can be used to replace a number of decade-resistance boxes. A decade resistor gives a large number of values in a narrow range; the TYPE 646-A Logarithmic Resistor gives fewer values distributed over a tremendously wide range.

There are numberless laboratory uses for the TYPE 646-A Logarithmic Resistor. It can be used in measuring circuits where a wide range of resistance values must be covered and where, though each value used must be accurately known, using, for example, 5000 ohms instead of 6000 ohms would cause no trouble. It can be used for a test load in transformer measurements and, because the switches are brought out to terminals, it can be used as a logarithmic voltage divider.

## SPECIFICATIONS

**Range:** 0 to 100.1 megohms in approximately logarithmic steps.

**Accuracy of Adjustment:** Individual resistors are adjusted as follows:

Between 0.1 k $\Omega$  and 2 k $\Omega$ , 0.1%; between 5 k $\Omega$  and 1.0 M $\Omega$ , 0.25%; 2 M $\Omega$  to 20 M $\Omega$ , 5%; 50 M $\Omega$  and 100 M $\Omega$ , 10%.

**Type of Winding:** The construction of the units below the 20,000-ohm point is similar to General Radio standard resistance-card construction. Between the 20,000-ohm and the 1-megohm steps IRC wire-wound units are used, above 1 megohm, the units are IRC metallized type.

**Frequency Characteristics:** The impedance for alternating currents of any frequency is given approximately by considering a capacitance of 20  $\mu\text{mf}$  with a power factor of 0.05 to be in parallel with the used portion of the "megohms" dial. Second order corrections may be made for a 2  $\mu\text{mf}$  capacitance between

the high-resistance terminal of the "megohms" dial and ground. For resistance uses the unused portion of the "megohms" dial should be short-circuited.

**Maximum Current:** Individual resistors between 0.1 k $\Omega$  and 0.5 k $\Omega$  will safely carry 70 ma. Between 1 k $\Omega$  and 1 M $\Omega$  each resistor will dissipate 1 watt. Resistors greater than 1 M $\Omega$  will dissipate 2 watts. The maximum voltage applied to the box should not exceed 500 volts.

**Terminals:** Separate binding posts are brought out from each switch and from one end of each group of resistors. A separate binding post for the shield is also provided.

**Mounting:** A copper-lined cabinet with an aluminum panel completely encloses both switches and resistors. The panel finish is black crackle lacquer.

**Dimensions:** (Length) 7 $\frac{3}{4}$  x (depth) 5 x (height) 5 inches.

**Net Weight:** 3 $\frac{1}{4}$  pounds.

Type	Code Word	Price
646-A	AWAKE	\$50.00

## TYPES 249, 329-J, and 529-B ATTENUATION BOXES

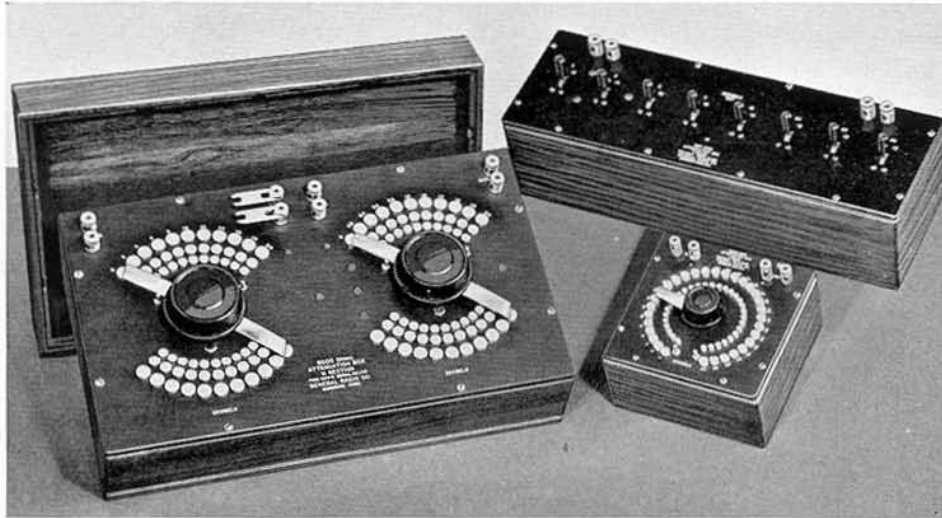

An attenuation network is a combination of resistance elements so arranged that it introduces a definite and known amount of power loss when put into a circuit between certain specified values of external output and input impedance. These three factors completely specify its performance at all frequencies for which the effects of reactance in the resistors and spurious admittances between them can be considered negligible.

These networks, when constructed with a switching mechanism for changing the amount of attenuation, are called "attenuation boxes" and have long been in common use throughout the communication engineering industries for making all kinds of transmission-efficiency and power-level measurements.

The TYPE 249 Attenuation Network, in which the attenuation is varied by means of key switches, is available in both T and balanced-H models. The TYPE 329, which uses a rotary switch, is supplied only in the balanced-H configuration. TYPE 529 is an L-type network which maintains constant impedance in one direction only.

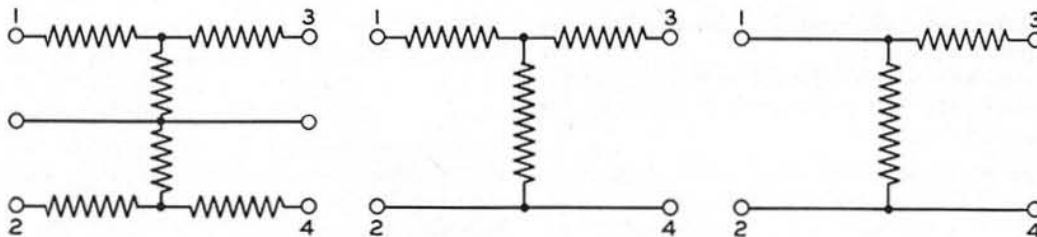

Balanced-H-section networks are used when impedances must be matched in both directions and balanced to ground. T-type sections maintain constant impedance in both directions, but they are not balanced to ground. L-type section maintains constant impedance at the 3-4 terminals

### SPECIFICATIONS

**Attenuation Range:** Boxes having a maximum attenuation range of 55 db or 110 db are listed in the price list. TYPE 329-J is composed of two sections in series, one of 50 db total attenuation in steps of 5 db, and the other of 5 db, total, in steps of 0.5 db. Removable external links make either section separately available.

Types 249-H and -T each have eight series sections with attenuations of 1, 2, 3, 4, 10, 20, 30, and 40 db, respectively.

TYPE 529 is a single section of 60 db, variable in steps of 2 db.

**Type of Section:** T-section, balanced-H-section, and L-section models are available. T- and H-types

present a constant impedance in both directions, but the balanced-H should be used where both sides of the circuit must be balanced to ground. The L-type presents a constant impedance in one direction only.

**Type of Windings:** Ayrton-Perry for the low-resistance elements and mica cards for the high-resistance elements.

**Terminal Impedance:** Boxes in the T- and H-types to operate between 500-ohm impedances are listed. Boxes for other impedance values can be made on special order. The L-type section is supplied for 6000 ohms only.

**Accuracy of Adjustment:** Each individual resistor is adjusted to within 0.25% of its correct value, so that the entire box is accurate to within 0.5% at frequencies up to at least 50 kc.

**Switching:** TYPE 249 has eight key switches to control the eight network sections.

TYPE 329-J has a multiple-blade switch and a positive detent which centers the switch blade on the contact point at each step.

TYPE 529 has two blades for each row of contacts, but no detent is provided.

**Mounting:** TYPES 249-H and 249-T are mounted in copper-lined walnut cabinets, with aluminum panels finished in black crackle lacquer.

The TYPE 529-B has a walnut cabinet with engraved bakelite panel.

**Dimensions:** TYPE 249: Panel, (length) 16 x (width) 5¼ inches. Cabinet, (depth) 5¼ inches, over-all.

TYPE 329: Panel, (length) 16⅞ x (width) 10¾ inches. Cabinet, (depth) 6 inches, over-all.

TYPE 529: Panel, (length) 8 x (width) 8 inches. Cabinet, (depth) 4 inches, over-all.

**Net Weight:** TYPE 249, 7⅛ pounds; TYPE 329, 12 pounds; TYPE 529, 2⅜ pounds.

Type	Attenuation Range	Impedance	Type of Section	Code Word	Price
249-H	110 db in steps of 1.0 db	500 ohms	Balanced-H	NETWORKROD	\$120.00
249-T	110 db in steps of 1.0 db	500 ohms	T	NETWORKTOP	100.00
329-J	55 db in steps of 0.5 db	500 ohms	Balanced-H	TENUTORPIG	155.00
529-B	60 db in steps of 2.0 db	6000 ohms	L	AFFIX	38.00

## TYPE 654-A DECADE VOLTAGE DIVIDER



This is a precision-type decade voltage divider which will supply exact voltage ratios between 0.001 and 1.000 in steps of 0.001. The internal input impedance of the instrument remains constant at 10,000 ohms for all settings of the decade dials.

This instrument may be thought of as a pair of TYPE 602 Decade-Resistance Boxes connected in series and manipulated so that as resistance is taken out of

one box it is added to the other to maintain the total series resistance constant. This is accomplished for each dial through the use of two TYPE 510 Decade-Resistance Units operated from the control knob by means of a chain drive.

### SPECIFICATIONS

**Range:** Voltage ratios of 0.001 to 1.000 in steps of 0.001 can be obtained by setting up the desired result on the three switches.

**Mounting:** Decades are mounted on an aluminum panel finished in black crackle lacquer and enclosed in a walnut cabinet.

**Dimensions:** Panel, (length) 13 x (width) 7 inches. Cabinet, (depth) 5¼ inches, over-all.

**Net Weight:** 8¼ pounds.

Type	Input Impedance	Code Word	Price
654-A	10,000 ohms	ABACK	\$85.00

## TYPE 500 RESISTOR

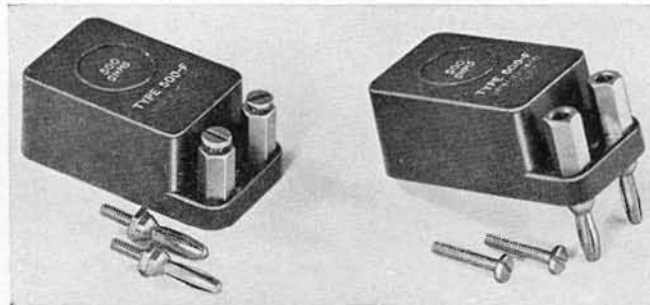

This is an accurately adjusted resistance card mounted in a bakelite case. Both screw-type and plug-type terminals are provided, so that the resistor may be easily connected in either experimental or permanent equipment. The terminals are set on standard  $\frac{3}{4}$ -inch spacing.

TYPE 500 Resistors are particularly recommended for use as resistance standards in plug-in type impedance bridges. They are also useful in test equipment (e.g., as terminating impedances in transmission line measurements). Their excellent high-frequency characteristics make them useful in receivers and low-power transmitters when stable performance is of primary importance.

Nine values of resistance are normally carried in stock, but others can be built to order. Quotations on request.

## SPECIFICATIONS

**Accuracy of Adjustment:** Each resistor is adjusted to within 0.1% of its stated value at the terminals of the unit, except the 1-ohm unit which is adjusted to within 0.25%.

**Maximum Current:** All units will dissipate a maximum power of 1 watt, current corresponding to which is given in the price list.

**Frequency Characteristics:** The error is less than 0.1% below 50 kc. At higher frequencies errors result from skin effect and the effect of reactance in the resistor. The tables on page 15 represent accurately the performance of the 1-ohm through 600-ohm values. For the higher values, the errors are much less than those tabulated because of the relatively negligible shunt capacitance of an isolated resistor.

**Temperature Coefficient:** Less than 0.002% per degree C.

**Type of Winding:** Ayrton-Perry when resistance is less than 200 ohms; 200 ohms and over, unifilar winding on mica cards.

**Terminals:** Both terminal screws and plugs are supplied, and either can be used. Each terminal stud is recessed as a jack to accommodate a plug.

**Mounting:** Each resistor is sealed in a case of black moulded bakelite with an impregnating wax that protects the unit from moisture. Two mounting holes are provided (see drawing).

**Dimensions:** (Length)  $2\frac{3}{4}$  x (width)  $1\frac{5}{16}$  inches. Over-all height, exclusive of plugs, 1 inch.

**Net Weight:** 2 ounces.

Type	Resistance	Maximum Current	Code Word	Price
500-A	1 $\Omega$	1.0 a	RESISTBIRD	\$2.00
500-B	10 $\Omega$	310 ma	RESISTDESK	2.00
500-C	50 $\Omega$	140 ma	RESISTFORD	2.00
500-D	100 $\Omega$	100 ma	RESISTFROG	2.00
500-E	200 $\Omega$	70 ma	RESISTGIRL	2.00
500-F	500 $\Omega$	45 ma	RESISTGOAT	2.00
500-G	600 $\Omega$	40 ma	RESISTGOOD	2.00
500-H	1000 $\Omega$	30 ma	RESISTHYMN	2.00
500-J	10,000 $\Omega$	10 ma	RESISTMILK	2.00



## TYPE 525 RESISTOR

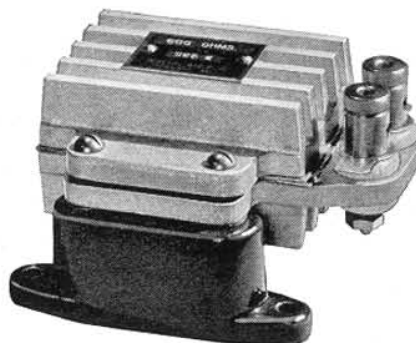

This precision-type resistor is capable of dissipating a large amount of power. It is intended for use in testing the output power of radio transmitters in dummy-antenna service and for use in general laboratory work requiring a resistor of both high precision and high power dissipation. The TYPE 525 Resistor consists of a mica card wound with resistance wire, clamped between two aluminum castings, and insulated from them by two thin sheets of mica, the whole unit being supported on porcelain insulators. The aluminum castings are heavily ribbed to give a large radiating surface.

This unit is nominally rated at 50 watts, although a considerably greater amount of power can be dissipated for long periods, without damage, if a large temperature rise can be tolerated.

## SPECIFICATIONS

**Power Rating:** All units will dissipate 50 watts for a 100°C. rise in temperature and 100 watts for a 150°C. rise.

**Maximum Current:** Values of current for a 100°C. rise in temperature are given in the price list.

**Accuracy:** All units are adjusted to be within 0.1% of the rated values specified in the price list.

**Temperature Coefficient:** Less than  $\pm 0.002\%$  per degree C. for temperatures below 100°C.

**Frequency Characteristics:** The frequency characteristics of these resistors are in general similar to those of TYPE 510 Decade-Resistance Units. Resistors of 100 ohms and below will increase in resistance with frequency and the increase is greater when the shield is connected to one side of the resistor than when it is floating. The 600-ohm unit shows an increase in resistance at frequencies up to several megacycles

when the shield is floating, but with the shield grounded to one side of the winding its resistance decreases with frequency and never rises above its nominal value.

**Shielding:** The aluminum castings can be used as an electrostatic shield, both resistor terminals being insulated from them.

**Terminals:** Jack-top binding posts mounted on isolantite washers on standard General Radio spacing of  $\frac{3}{4}$  inch.

**Mounting:** Resistors are wound unifilarly on mica and clamped between two pieces of mica and two heavily ribbed aluminum castings, the whole unit being supported on porcelain insulators.

**Dimensions:** (Length) 4 x (width) 4 x (height)  $2\frac{1}{2}$  inches.

**Net Weight:**  $1\frac{1}{4}$  pounds.

Type	Resistance	Current, 100°C. Rise	Code Word	Price
525-C	4 ohms	3.5 a	CABAL	\$8.00
525-D	10 ohms	2.2 a	CABIN	8.00
525-F	40 ohms	1.1 a	CABOB	8.00
525-H	100 ohms	0.7 a	CADDY	8.00
525-L	600 ohms	0.09 a	CADET	8.00

## TYPE 653 VOLUME CONTROL

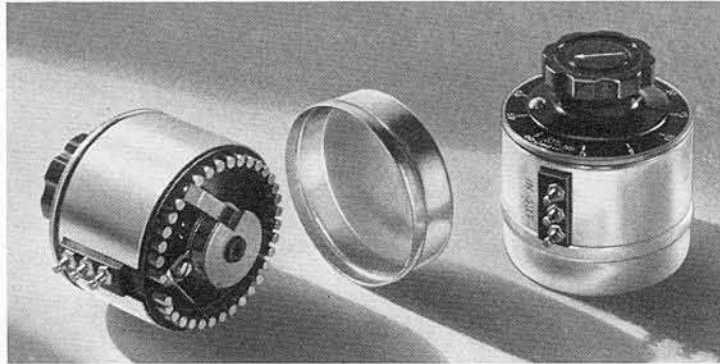

TYPE 653 Volume Control is a small, compact attenuation network for use as microphone mixers and master gain controls. Its low noise level, trouble-free operation, and low cost make it an ideal instrument for this purpose. Thousands are in use in broadcasting and recording studios.

Extremely low noise level is achieved by using only one three-bladed sliding contact with both switch blade and contacts of the same material, beryllium copper.

The impedance remains practically constant in both directions throughout the attenuation range.

A two-section aluminum cover serves as a protection against dust and as an electrostatic shield. The rear section of the cover is removable to allow contacts to be cleaned, while the other section protects the winding and is removed only when the unit is being installed.

## SPECIFICATIONS

**Attenuation Range:** 0 db to complete cut-off. Attenuation is linear with dial setting and adjustable from 0 to 45 db in steps of about  $\frac{3}{4}$  db. (Attenuation between contacts is 1.5 db, but the switch bridges two contacts in passing from one to the other.) Above 45 db, the rate of attenuation increases rapidly to "infinity" (about 120 db with the usual type of mixer wiring).

**Type of Section:** A ladder-type network is employed.

**Type of Winding:** Resistors are wound on cylindrical spools which are part of the bakelite moulding.

**Terminal Impedance:** 50-, 200-, 250-, and 500-ohm units are carried in stock, but others can be built to order at a slight additional cost.

**Shielding:** A two-section aluminum cover is provided. One section is removable and gives access to the contacts for cleaning; the other acts as a dust cover and shield for the windings.

**Switch:** A 3-bladed beryllium-copper switch makes firm contact with beryllium-copper contact points.

**Terminals:** Screw terminals are provided.

**Dial Plate:** A dial plate calibrated directly in decibels also serves as a drilling template in mounting volume control.

**Knob:** TYPE 637-K, with engraved white arrow. A button is provided on the skirt of the knob for convenience when the control is used in dimly-lighted monitoring booths.

**Mounting:** The unit is arranged for panel mounting by means of two screws which are supplied. It may be mounted on panels up to  $\frac{3}{8}$  inch in thickness. Holes are spaced  $1\frac{1}{2}$  inches apart.

**Dimensions:** Maximum over-all radius,  $1\frac{3}{4}$  inches. Maximum depth behind panel,  $2\frac{5}{8}$  inches. Shield diameter,  $2\frac{3}{4}$  inches.

**Net Weight:** 13 ounces.

Type	Impedance	Code Word	Price
653-MA	50 $\Omega$	CLUMP	\$12.50
653-MB	200 $\Omega$	COACH	12.50
653-MD	250 $\Omega$	CARAT	12.50
653-MC	500 $\Omega$	COAST	12.50

## TYPE 552 VOLUME CONTROL

This unit has been designed primarily as a master gain control in high-quality broadcast transmission, sound-recording and projection, and public-address systems. Because of its accuracy, excellent frequency characteristic, and compactness, it will be found useful in measuring circuits where the expense of high-precision attenuation networks is not justified.

The design of the individual resistors makes a very rigid mechanical construction.

No slide-wire contacts are used; the action is entirely step by step. This increases the reliability of the unit, at the same time making exact duplication of attenuation settings easily possible. The step-by-step contacts used in this volume control also have a lower noise level than the best of sliding contacts.

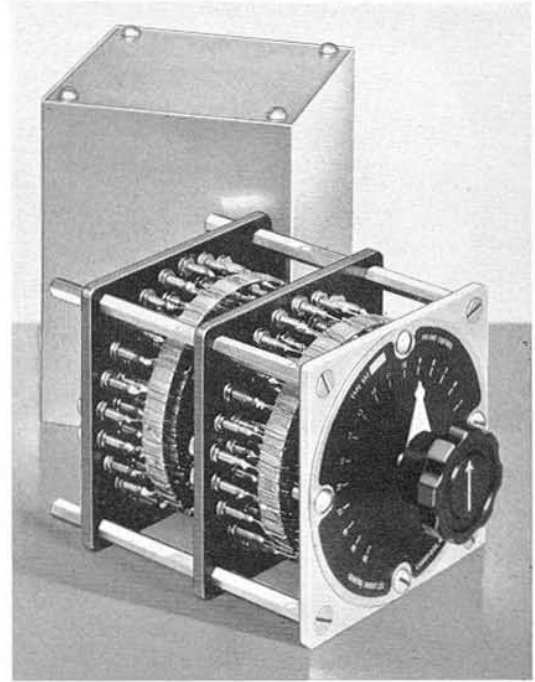

### SPECIFICATIONS

**Range:** One range, 0 db to 30 db, in steps of 1.5 db is carried in stock, but special ranges can be built to order.

**Type of Section:** T-section and balanced-H-section models are available.

**Type of Winding:** Unifilar winding on bakelite strips as shown in the accompanying illustration.

**Terminal Impedance:** Units for working in 500-ohm circuits are carried in stock, but others can be built to order.

**Accuracy:** All resistors are adjusted to within 2%, which makes the error in attenuation less than 1 db at all settings up to 20 kc.

**Switch:** A multiple blade switch is used.

**Mounting:** The entire unit is supported on a square aluminum sub panel that can be mounted on a panel by means of the same four machine screws that hold the etched-metal dial plates.

**Terminals:** A terminal strip mounted with soldering lugs is mounted behind the sub panel.

**Dimensions:** Sub panel,  $4\frac{1}{4}$  x  $4\frac{1}{4}$  inches; depth behind panel: 3 inches for T-section models;  $5\frac{1}{2}$  inches for balanced-H-section models.

**Net Weight:** 2 pounds for T-section, 3 pounds for balanced-H-section models.

Type	Attenuation	Impedance	Section	Code Word	Price
552-TC	30 db in steps of 1.5 db	500 $\Omega$	T	ALARM	\$28.00
552-HC	30 db in steps of 1.5 db	500 $\Omega$	Balanced-H	AGAIN	48.00

## TYPE 642-D VOLUME CONTROL

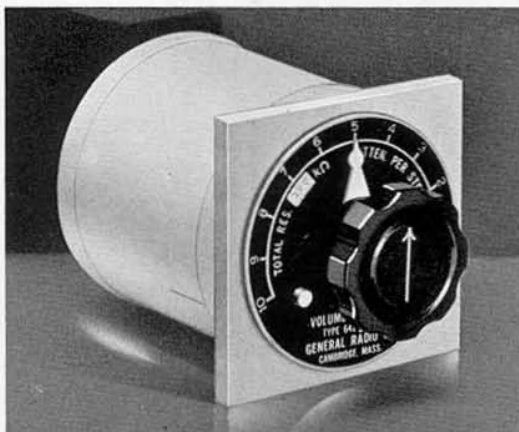

This high-impedance potentiometer-type voltage-divider unit is intended for use as a gain control in the input circuit of a vacuum tube or as a multiplier for a vacuum-tube voltmeter. It is compact and ruggedly constructed, the contact noise level being sufficiently low to permit of its use in the highest quality circuits.

With sufficient care in keeping down the stray capacitances in the wiring between the volume control output and the socket, the calibration is accurate to within 0.1 db at all frequencies up to 16,000 cycles.

Only one type is available in stock, but units having different values of impedance or of attenuation per step can be built to order. Prices on request.

### SPECIFICATIONS

**Range:** One range, 0 db to 30 db, in steps of 3 db is carried in stock, but other sizes can be built to order.

**Type of Winding:** IRC wire-wound resistors are used.

**Terminal Impedance:** The input impedance of the unit is 200,000 ohms when the switch side is connected across an essentially infinite-impedance load.

**Accuracy:** All resistors are adjusted to within 1%, which makes attenuation ratios accurate to within 0.1 db. If capacitance of tube, socket, and wiring is less than 20  $\mu\mu\text{f}$ , as is usually the case, the rated accuracy limit of 0.1 db holds to approximately 10,000 cycles.

**Maximum Current:** Although normally used in circuits drawing no current, a current of 4 ma will not cause a temperature rise sufficient to affect the rated accuracy.

**Switch:** The switch arm is constructed of four-leaf phosphor bronze, which provides for long wear and exceptionally low contact noise. The cam-type detent

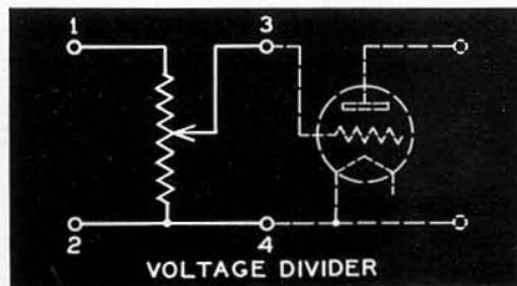

may be easily removed if smooth switch action is required.

**Mounting:** This unit is similar in construction to the TYPE 510 Decade-Resistance Units.

**Terminals:** Three soldering lugs are placed at the end of the unit for making connections, and the shield has a small opening for connecting wires.

**Dimensions:** Shield diameter,  $3\frac{1}{16}$  inches; depth behind panel,  $3\frac{1}{16}$  inches.

**Net Weight:** 16 ounces.

Type	Attenuation		Impedance	Code Word	Price
	Total	Steps			
642-D	30 db	3 db	200,000 $\Omega$	EXALT	\$25.00



## TYPE 526 MOUNTED RHEOSTAT-POTENTIOMETER



The TYPE 526 Mounted Rheostat-Potentiometer is supplied for measurements where a calibrated rheostat-potentiometer is sufficiently accurate. The total resistance is adjusted to within  $2\frac{1}{2}$  per cent of the rated value, and a direct-reading scale with a calibration accurate within 5 per cent is provided.

The resistance unit uses a four-finger contact-arm construction which averages out the variations of the individual finger contact resistances and so gives a smooth and linear resistance-rotation curve upon which settings may be easily repeated.

A mounted resistor of this type is recommended for power-factor measurements with the TYPE 625-A Bridge, described on page 90 of this catalog, or for the variable standard in approximate

measurements of resistance values by bridge methods.

On order, any General Radio standard three-hole mounting rheostat-potentiometer, including tapered models, may be obtained mounted in this manner using the TYPE 318-A Dial Plate described on page 154 for the scale. Calibrations are extra; prices will be supplied on request.

## SPECIFICATIONS

**Winding:** The winding is a carefully adjusted TYPE 471-A Rheostat-Potentiometer (see page 129).

**Accuracy:** The total resistance has been adjusted to within 2.5% of the rated value in the price list. The calibration is accurate to within 5% of full scale.

**Mounting:** Drawn-steel cases with hard-rubber panel for protection of unit and for convenience in wiring into experimental circuits. The case may be used as an electrostatic shield.

**Terminals:** Two pairs of jack-top binding posts, one

for input and one for output, on standard General Radio spacing of  $\frac{3}{4}$  inch, are provided.

**Dial Plate:** Each unit has a 3-inch photo-engraved dial plate with 50 divisions and is calibrated directly in ohms.

**Finish:** Black crystalline lacquer.

**Dimensions:** (Diameter)  $4\frac{1}{2}$  x (height)  $4\frac{3}{8}$  inches, over-all.

**Net Weight:**  $1\frac{1}{2}$  pounds.

Type	Resistance	Max. Current	Code Word	Price
526-D	0- 100 ohms	330 ma	ETHER	\$8.50
526-A	0- 1000 ohms	104 ma	EVADE	8.50
526-B	0- 10,000 ohms	33.0 ma	EVENT	8.50
526-C	0-100,000 ohms	10.4 ma	EVOKE	8.50



### RHEOSTAT-POTENTIOMETERS

Rheostat-potentiometers in a large variety of types and sizes are described on pages 127 to 131. These range in maximum resistance from 0.75 ohm to 200,000 ohms and in maximum power rating from 5 watts to 250 watts.



# CONDENSERS

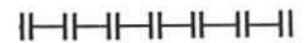

AIR AND MICA  
CAPACITANCE  
STANDARDS



GENERAL-PURPOSE  
CONDENSERS WITH  
AIR, MICA, AND  
PAPER DIELECTRIC

## TYPE 722 PRECISION CONDENSER

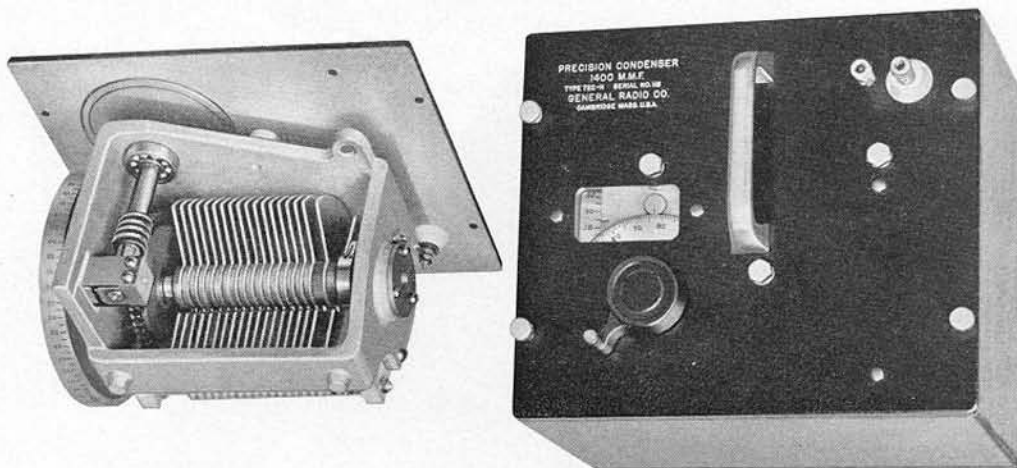

The TYPE 722 Precision Condenser is intended for use as an adjustable air-dielectric capacitance standard. It is designed to have a high degree of stability under constant laboratory usage. Both the materials and the mechanical arrangement have been selected with this end in view.

The whole condenser assembly is mounted in a cast frame which gives the assembly a degree of rigidity not otherwise possible. This frame, the stator rods and spacers, and the rotor shaft are made of an alloy of aluminum and copper, which combines the mechanical strength of brass with the weight and temperature coefficient of aluminum. Since the condenser plates are of aluminum, all parts have the same temperature coefficient of linear expansion, resulting in a low temperature coefficient of capacitance (0.002 per cent per degree Centigrade).

In models where space permits, increased stability is also obtained by the use of plates  $\frac{1}{16}$  inch thick, which reduces materially the sagging which might normally occur with age, and, since the rotor shaft is horizontal, no constant stress exists which would cause the plates to bend in a direction parallel to the shaft.

Since it is difficult to mount a worm gear on a shaft without some slight eccentricity, the worm in the TYPE 722 Precision Condenser is cut directly on the shaft. The dial end of the worm shaft runs in ball bearings; the other end is supported by an adjustable spring mounting. Ball bearings are used at both ends of the rotor shaft. This arrangement of bearings and drive mechanism results in a backlash of less than  $\frac{1}{2}$  worm division and an extremely low worm correction.

Connection to the rotor is made, not through the bearing, but by means of a phosphor-bronze brush running on a brass drum, which assures positive contact.

Losses are low and constant with setting over the usable portion of the scale, because only a small amount of solid dielectric is used and this is placed in a weak and constant electric field. This feature is especially important when the condenser is to be used for determining dielectric loss by the bridge-substitution method. The solid dielectric is isolantite, but a smaller amount is used than in the older TYPE 222 Precision Condenser, which results in a better figure of merit and a lower surface leakage.

The precision of setting is more than adequate for all measurement uses. All models can be set to one part in 25,000 of full scale.

Calibrations for capacitance at the terminals are accurate to  $1.0 \mu\mu\text{f}$  or 0.1 per cent, whichever is the larger. The internal consistency of the calibration is good to 0.1 per cent of full scale.



A more precise calibration with a worm correction can be supplied for larger models giving corrections which permit an internal consistency of 0.1  $\mu\mu\text{f}$ . The accuracy at the terminals, however, is still limited to approximately  $\pm 1.0 \mu\mu\text{f}$  by the lack of a standard technique for connecting the condenser into a measuring circuit.

Three capacitance ranges are carried in stock. TYPE 722-F, with a maximum capacitance of 500  $\mu\mu\text{f}$ , can be supplied either mounted in a cabinet or unmounted. No calibration is supplied with unmounted models.

TYPE 722-D is direct reading over two ranges, 25 to 100  $\mu\mu\text{f}$  and 100 to 1100  $\mu\mu\text{f}$ . TYPE 722-M is intended for use in bridge measurements by the substitution method. It is direct reading in capacitance difference (i.e., capacitance removed from the circuit) over a range of 1000  $\mu\mu\text{f}$ . Neither direct-reading model is supplied unmounted.

Prices for mounted models include a whitewood carrying case.

### SPECIFICATIONS

**Capacitance Range:** Three stock models are available: TYPE 722-D, direct reading in capacitance over two ranges, 25 to 100  $\mu\mu\text{f}$  and 100 to 1100  $\mu\mu\text{f}$ ; TYPE 722-M, intended for bridge-substitution measurements and direct reading in capacitance removed from the condenser over a range of 1000  $\mu\mu\text{f}$ ; and TYPE 722-F, a calibrated 500- $\mu\mu\text{f}$  model.

**Rotor Plate Shape:** Semicircular for all models, to give a linear capacitance characteristic.

**Maximum Safe Voltage:** All models, 1000 volts peak value.

**Dielectric Supports:** Two bars of isolantite support the stator assembly. Quartz insulation can be supplied. See price list.

**Losses:** The figure of merit,  $R\omega C^2$ , is  $0.04 \times 10^{-12}$  for isolantite insulation,  $0.003 \times 10^{-12}$  for quartz.

**Drive:** A worm and gear drive is used. To reduce irregularities and backlash the worm is cut integral with the shaft. Backlash is less than  $\frac{1}{2}$  worm division. If the desired setting is always approached in

the direction of increasing scale reading, no calibration error will result.

**Calibration:** None required for direct-reading models. TYPE 722-F is supplied with a mounted chart, giving the capacitance to the nearest 0.5  $\mu\mu\text{f}$  for 51 points. The capacitance difference for each pair of settings is also given on the chart to facilitate interpolation. An alternative chart giving the capacitance to 0.1  $\mu\mu\text{f}$  and a worm correction can be supplied. See price list. The absolute capacitance, however, is good only to 1.0  $\mu\mu\text{f}$ .

**Mounting:** Mounted models are attached to an aluminum panel finished in black crackle lacquer and enclosed in a shielded walnut cabinet. A wooden storage case with lock and carrying handle is included.

**Dimensions:** (Mounted models) Panel,  $8 \times 9\frac{1}{8}$  inches; depth,  $8\frac{1}{8}$  inches. (Unmounted models)  $7\frac{3}{4}$  (length)  $\times 6\frac{3}{8}$  (width)  $\times 7$  (depth) inches.

**Weight:**  $11\frac{1}{8}$  pounds;  $20\frac{1}{4}$  pounds with carrying case.

### MOUNTED MODELS

Type	Capacitance Range	Code Word	Price
722-F	45 to 500 $\mu\mu\text{f}$ .....	CUBIT	\$85.00
722-D	25 to 100 $\mu\mu\text{f}$ and 100 to 1100 $\mu\mu\text{f}$ , direct reading .....	CRUEL	110.00
722-M	0 to 1000 $\mu\mu\text{f}$ , direct reading in capacitance removed from circuit .....	COMIC	100.00
Worm correction calibration data for above condensers.....		WORMY	35.00

### UNMOUNTED MODEL

Type	Maximum Capacitance	Code Word	Price
722-FU	500 $\mu\mu\text{f}$	CUBITPANEL	\$65.00

### QUARTZ INSULATION

Any TYPE 722 Precision Condenser can be obtained with quartz insulation.

	Code Word	Additional Price
Quartz Insulators .....	QUATZ	\$55.00

When ordering use compound code word, CUBITQUATZ, etc.

TYPE 246 VARIABLE AIR CONDENSER

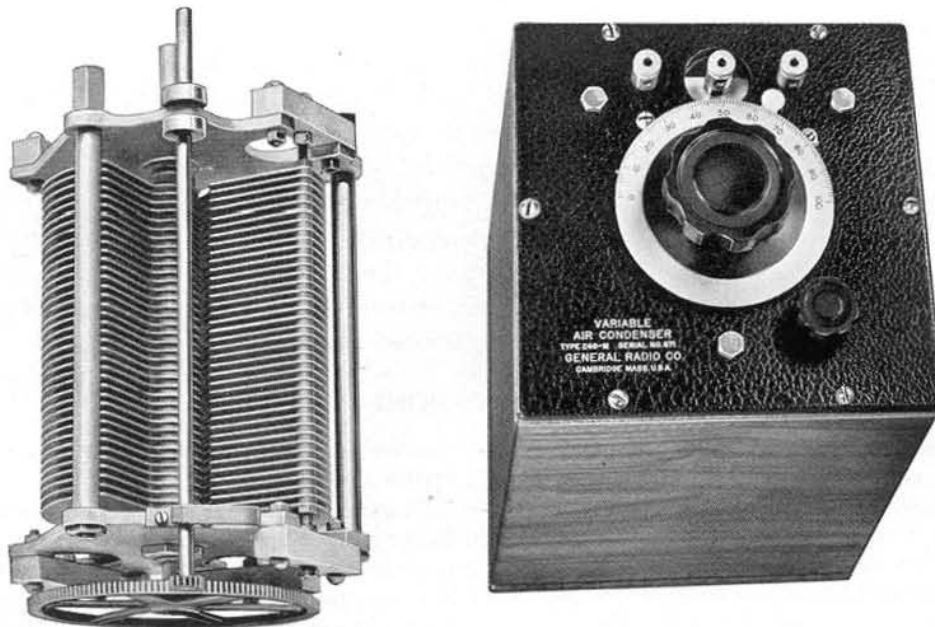

This condenser is for use in measuring and experimental circuits requiring a high-grade unit in which extreme precision of setting and accuracy of calibration are not required — as the “balancing condenser” in the substitution method of capacitance measurement, for example.

It is rigidly constructed, with cast end plates and isolantite insulation. Mechanically and electrically it is similar to the TYPE 222 Precision Condenser (now obsolete, see previous catalogs), but it has no worm drive.

SPECIFICATIONS

**Capacitance Range:** Three sizes, 1500  $\mu\mu\text{f}$ , 3000  $\mu\mu\text{f}$ , and 5000  $\mu\mu\text{f}$ , are carried in stock.

**Drive:** A spur-gear slow-motion drive having a ratio of 10:1 is an auxiliary control for the large knob and dial mounted on the rotor shaft.

**Calibration:** No calibration is supplied with this condenser, but a mounted calibration curve accurate to within 0.5% of full scale or a mounted calibration table for 11 points, accurate to 0.5% of full scale, can be prepared to order. See the price list.

**Maximum Voltage:** TYPE 246-L and TYPE 246-M are rated at 800 volts, peak; TYPE 246-P, 500 volts, peak.

**Mounting:** The condenser is mounted on an aluminum panel, finished in black crackle lacquer and enclosed in a shielded walnut cabinet.

**Dimensions:** Panel,  $7\frac{1}{2} \times 7\frac{1}{2}$  inches. Cabinet, (height) for TYPE 246-L,  $8\frac{3}{8}$  inches; for TYPES 246-M and 246-P,  $11\frac{3}{8}$  inches, over-all.

**Net Weight:** TYPE 246-L,  $11\frac{1}{4}$  pounds; TYPES 246-M and 246-P, 15 pounds.

Type	Nominal Capacitance		Code Word	Price
	Maximum	Minimum		
*246-L	1500 $\mu\mu\text{f}$	55 $\mu\mu\text{f}$	CEDAR	\$38.00
*246-M	3000 $\mu\mu\text{f}$	70 $\mu\mu\text{f}$	CHAOS	45.00
*246-P	5000 $\mu\mu\text{f}$	72 $\mu\mu\text{f}$	CHARY	54.00
Mounted Calibration Curve .....			CURVE	4.00
Mounted 11-point Calibration Table .....			CHART	3.50

\*Calibrations supplied only when ordered. Use compound code words, e.g., CEDARCHART, CHAOSCHART, etc.

## TYPE 539 VARIABLE AIR CONDENSER

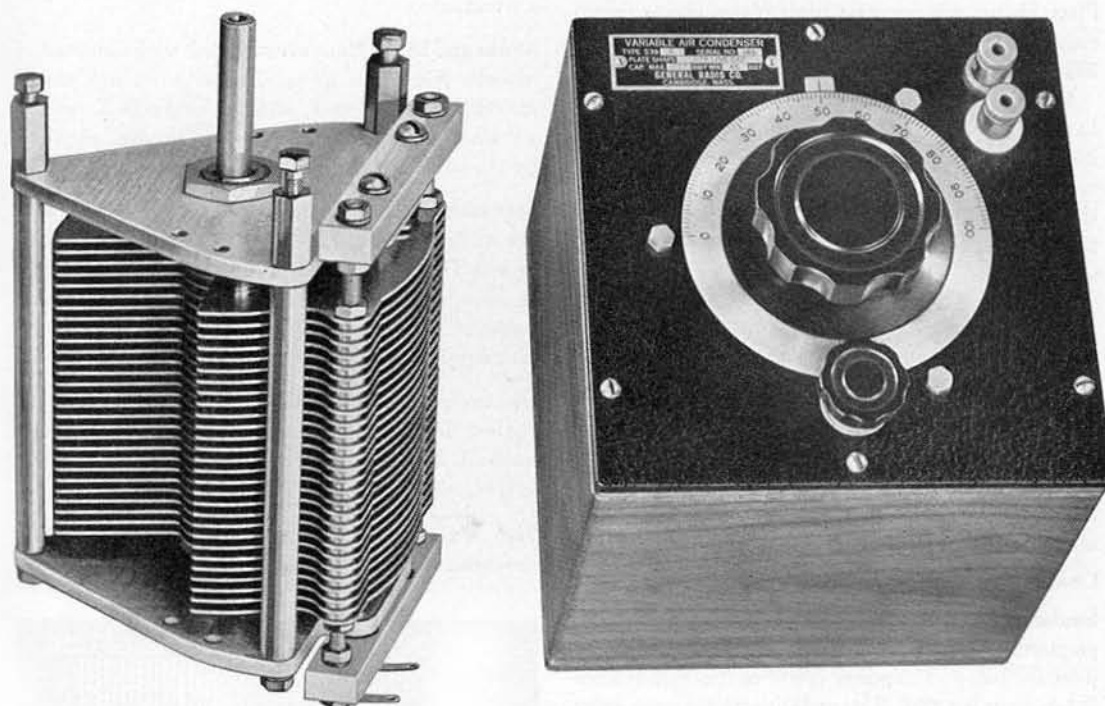

TYPE 539 Variable Air Condenser is a general-purpose instrument. Lower in price than the TYPE 722 and TYPE 246 Condensers, it is, nevertheless, a well-designed, carefully constructed instrument with good electrical and mechanical characteristics.

Mounted models find a wide use as laboratory condensers for bridge measurements or in experimental circuits. Unmounted types are used as the variable capacitance in beat-frequency oscillators and standard-signal generators made by the General Radio Company, as well as in those of other manufacturers.

Three brass rods, extensions of which serve as mounting pillars, rigidly support the two end plates, on each of which is a block of isolantite carrying the two rods to which the stator is attached. This method insures low losses and facilitates the use of special plate shapes, like those used in TYPES 539-T, 539-TA, and 539-X.

Mounted models are supplied only with semicircular plates giving a linear capacitance variation. These are also available unmounted. In addition, the following models with plates shaped for specific uses are available:

TYPE 539-T (Straight-line-frequency)

TYPE 539-TA (Straight-line-frequency with insulated rotor)

TYPE 539-X (Special spread-out scale for beat-frequency oscillators)

A complete description of these models is given in the specifications.

TYPE 539-TA is intended for use in circuits where both sides of the condenser must be above ground potential. The insulated rotor construction results in an extremely low power factor for the direct capacitance between rotor and stator. For complete data, see specifications.

Mounted models can be supplied with calibrations if desired. See price list.

## SPECIFICATIONS

**Capacitance Range:** See price list.

**Plate Shape:** Semicircular rotor plates giving linear capacitance variation with setting are used on TYPES 539-J, 539-K, and 539-L and on all mounted models.

Rotor plates for TYPES 539-T and 539-TA are cut to give a linear frequency variation with setting over 250° of a possible 270° angle of rotation when a capacitance of 25  $\mu\text{mf}$  is connected in parallel with the condenser. A counterclockwise rotation from the minimum capacitance position of 40°, 90°, 230°, and 255° increases the capacitance by 0.4%, 5%, 82%, and 100%, respectively, of the total increment.

TYPE 539-X has a spread-out scale for use on a beat-frequency oscillator. A counterclockwise rotation from the minimum capacitance position of 40°, 90°, 230°, and 255° increases the capacitance by 0.4%, 5%, 82%, and 100%, respectively, of the total increment.

**Supports:** Two bars of isolantite, treated to prevent absorption of moisture, support the stator assembly.

**Low Losses:**  $R\omega C^2$  is approximately  $0.03 \times 10^{-12}$ .

**Insulated Rotor Model (Type 539-TA):** Direct capacitance between rotor and stator is given in the price list below. The power factor of this capacitance is less than 0.00002. The capacitance between rotor and frame is 24  $\mu\text{mf}$ ; that between stator and frame is 12  $\mu\text{mf}$ .

**Maximum Voltage:** TYPE 539-J is rated at 1100 volts, peak; TYPE 539-K at 800 volts, peak; and TYPES 539-L, 539-T, 539-TA, and 539-X at 550 volts, peak.

**Mounting:** Both mounted and unmounted models are available.

**Knobs and Dials:** None are supplied with unmounted models. Note that all models have  $\frac{3}{8}$ -inch shafts and that TYPES 539-T, 539-TA, and 539-X require a scale spread over 270°, instead of the 180° required by the other types.

**Terminals:** On unmounted models, soldering lugs are mounted on the lower isolantite support of all except TYPE 539-TA. The rotor connection for this condenser is brought out through an isolantite bushing in the rear end plate. Mounted models have jack-top binding posts mounted on the panel.

**Dimensions:** Unmounted models, see accompanying outline drawing; depth behind panel (A) 6 inches, over-all. Mounted models, panel,  $6\frac{1}{2} \times 6\frac{1}{2}$  inches; height,  $8\frac{3}{4}$  inches, over-all.

**Net Weight:** Approximately  $2\frac{3}{4}$  pounds for unmounted models;  $6\frac{3}{4}$  pounds for mounted models.

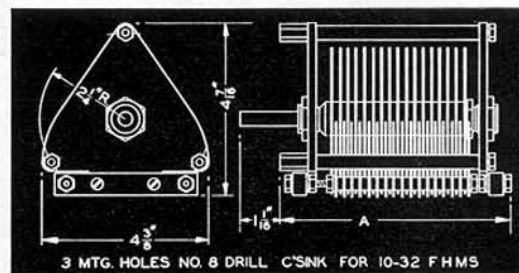

### UNMOUNTED MODELS

Type	Nominal Capacitance		Description	Code Word	Price
	Maximum	Minimum			
539-J	500 $\mu\text{mf}$	40 $\mu\text{mf}$	Straight-line capacitance	ATLAS	\$10.00
539-K	1000 $\mu\text{mf}$	40 $\mu\text{mf}$	Straight-line capacitance	ATONE	11.00
539-L	2000 $\mu\text{mf}$	40 $\mu\text{mf}$	Straight-line capacitance	ATTIC	12.00
539-T	500 $\mu\text{mf}$	30 $\mu\text{mf}$	Straight-line frequency	CLOSE	12.00
539-TA	500 $\mu\text{mf}$	18 $\mu\text{mf}$	Straight-line frequency, insulated rotor	CLOTH	15.00
539-X	900 $\mu\text{mf}$	40 $\mu\text{mf}$	Special spread-out scale	AUGER	12.00

### MOUNTED MODELS

Type	Nominal Capacitance		Code Word	Price
	Maximum	Minimum		
*539-A	500 $\mu\text{mf}$	50 $\mu\text{mf}$	ASSAY	\$22.00
*539-B	1000 $\mu\text{mf}$	55 $\mu\text{mf}$	ASSET	23.00
*539-C	2000 $\mu\text{mf}$	60 $\mu\text{mf}$	ASTER	24.00
Mounted Calibration Curve			CURVE	4.00
11-point Calibration Table			CHART	3.50

\*Calibrations supplied only when ordered. Use compound code words, ASSAYCHART, ASSETCHART, or ASTERCHART. PATENT NOTICE. See Note 17, page v.



## TYPE 247 VARIABLE AIR CONDENSER

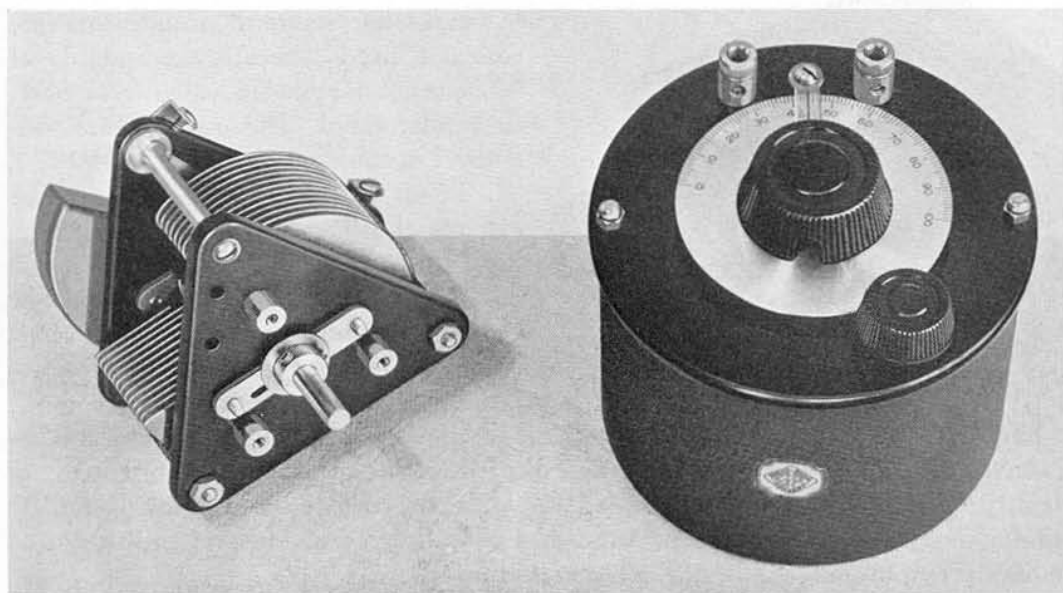

This is an inexpensive condenser with a number of features that make it popular in the laboratory development of experimental apparatus. The plates are of brass. Each stack is soldered together to form a rugged unit of low resistance, and the use of hard rubber insulation keeps the losses low.

Two models are available: one with straight-line-capacitance plates, mounted in a metal case; the other unmounted, with plates shaped to give an approximately straight-line-wavelength characteristic.

## SPECIFICATIONS

**Capacitance Range:** See price list.

**Plate Shape:** TYPE 247-G, straight-line-capacitance; TYPE 247-F, straight-line-wavelength, decreasing for clockwise rotation.

**Losses:**  $R\omega C^2$  is approximately  $0.08 \times 10^{-12}$ .

**Maximum Voltage:** 500 volts, peak.

**Drive:** TYPE 247-G is supplied with a gear drive having a 6:1 reduction ratio. TYPE 247-F is supplied without knob. The shaft diameter is  $\frac{1}{4}$  inch.

**Mounting:** TYPE 247-G is mounted in a drawn-steel case with hard rubber panel. A drilling template and three flat-head screws are supplied with TYPE 247-F.

**Dimensions:** TYPE 247-G, (diameter)  $4\frac{1}{2}$  x (height)  $4\frac{1}{4}$  inches. TYPE 247-F, panel space,  $3\frac{7}{8}$  x  $3\frac{7}{8}$  inches; depth behind panel,  $3\frac{3}{8}$  inches.

**Net Weight:** TYPE 247-G,  $2\frac{1}{2}$  pounds; TYPE 247-F,  $1\frac{3}{8}$  pounds.

Type	Nominal Capacitance		Code Word	Price
	Maximum	Minimum		
247-G	500 $\mu\mu\text{f}$	30 $\mu\mu\text{f}$	COLIC	\$5.75
247-F	500 $\mu\mu\text{f}$	20 $\mu\mu\text{f}$	COCOA	3.00



## UNMOUNTED VARIABLE AIR CONDENSERS

ranging from 15  $\mu\mu\text{f}$  to 1150  $\mu\mu\text{f}$  maximum capacitance are listed on pages 132 to 134.

## TYPE 509 STANDARD CONDENSER

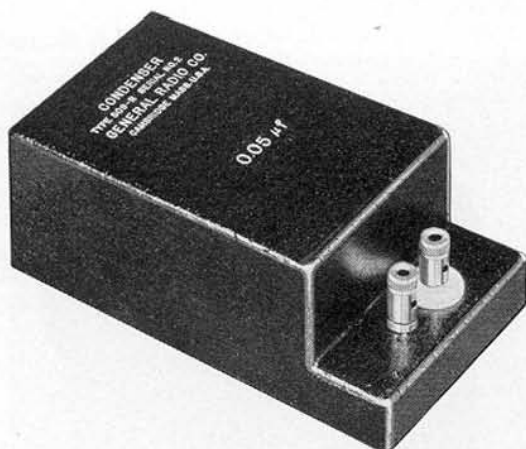

TYPE 509 Standard Condensers are compact fixed laboratory standards of capacitance ranging in value from 0.001 to 1 microfarad. The use of these condensers in conjunction with a TYPE 722-L or TYPE 722-M Precision Condenser extends the range of precision measurement by a direct substitution method well into the large capacitance values. The error in a composite standard so formed is less than 0.1 per cent or 1 micromicrofarad, whichever is the greater.

Large fixed-capacitance standards with air dielectric are prohibitive in cost and are inconvenient in the weight and size necessitated by the mechanical requirements of rigidity. Solid dielectrics, while not as stable as air, are the best solution and, by careful design and construction, variations caused by temperature, pressure, and humidity can be reduced to negligible importance.

Each TYPE 509 Standard Condenser consists of two TYPE 505 Condenser Units which have been put through an additional aging process. The stability of the units after the repeated aging cycles is better than the accuracy of the final calibration, 0.1 per cent.

The final value of the finished condenser is measured with an error of less than 0.1 per cent or 1 micromicrofarad, whichever is the larger, and is entered with the date on a calibration certificate supplied with each condenser.

These condensers are mounted in cast aluminum cases which act as shields. The terminals are jack-top binding posts (one of which is mounted directly on the case). Auxiliary TYPE 274-P Plugs fit directly into the jack tops of the terminals immediately below. When plugged in in this way the capacitance values are added by being placed in parallel, and the cases are all connected together, thus reducing to a minimum the proximity effects between condensers.

## SPECIFICATIONS

**Capacitance:** Ten values of capacitance between 0.001  $\mu\text{f}$  and 1.0  $\mu\text{f}$  are available in stock.

**Accuracy of Adjustment:** Each condenser is carefully adjusted to within 0.25% of the nominal capacitance value engraved on the case.

**Accuracy of Calibration:** After each condenser has been aged, adjusted, and mounted, its capacitance is measured as carefully as possible, and the value of capacitance, accurate to within 0.1%, is entered on a certificate of calibration which is packed with each unit.

**Stability:** Over reasonable periods of time (e.g., one year) each condenser will maintain its calibrated value to within 0.1%.

**Temperature Coefficient:** Less than 0.01% per degree C.

**Power Factor:** The power factor of all sizes listed is less than 0.05%.

**Maximum Voltage:** See price list. This rating means that the condenser will withstand safely the a-c voltage whose peak equals the given rating up to the given frequency. Above that frequency, the allowable voltage decreases inversely with the square root of the frequency because of the power loss.

**Mounting:** Two sizes of cast aluminum cases are used, depending upon the physical dimensions of the condenser stack. The price list shows the type of case used.

**Terminals:** Two jack-top binding posts spaced  $\frac{3}{4}$  of an inch apart are mounted on the case. One terminal is grounded, and the other one is insulated by means of an isolantite bushing.

**Dimensions:** Small case, (length)  $4\frac{7}{8}$  inches x (width)  $2\frac{1}{2}$  inches x (height)  $1\frac{7}{8}$  inches, over-all. Large case, (length) 6 inches x (width)  $3\frac{3}{8}$  inches x (height)  $2\frac{3}{8}$  inches, over-all.

**Net Weight:** One and one-half pounds for all condensers mounted in small cases;  $2\frac{1}{2}$  pounds to  $3\frac{1}{2}$  pounds for all condensers mounted in large cases.

Type	Capacitance	Peak Volts	Frequency	Case	Code Word	Price
509-F	0.001 $\mu\text{f}$	500	2500 kc	Small	GOODCONBOY	\$12.50
509-G	0.002 $\mu\text{f}$	500	1250 kc	Small	GOODCONBUG	12.50
509-K	0.005 $\mu\text{f}$	500	500 kc	Small	GOODCONCAT	12.50
509-L	0.01 $\mu\text{f}$	500	250 kc	Small	GOODCONDOG	12.50
509-M	0.02 $\mu\text{f}$	500	125 kc	Small	GOODCONEYE	15.00
509-R	0.05 $\mu\text{f}$	500	80 kc	Large	GOODCONPIG	18.00
509-T	0.1 $\mu\text{f}$	500	40 kc	Large	GOODCONROD	22.00
509-U	0.2 $\mu\text{f}$	500	20 kc	Large	GOODCONSIN	25.00
509-X	0.5 $\mu\text{f}$	500	8 kc	Large	GOODCONSUM	32.00
509-Y	1.0 $\mu\text{f}$	500	4 kc	Large	GOODCONTOP	48.00

## TYPE 505 CONDENSER

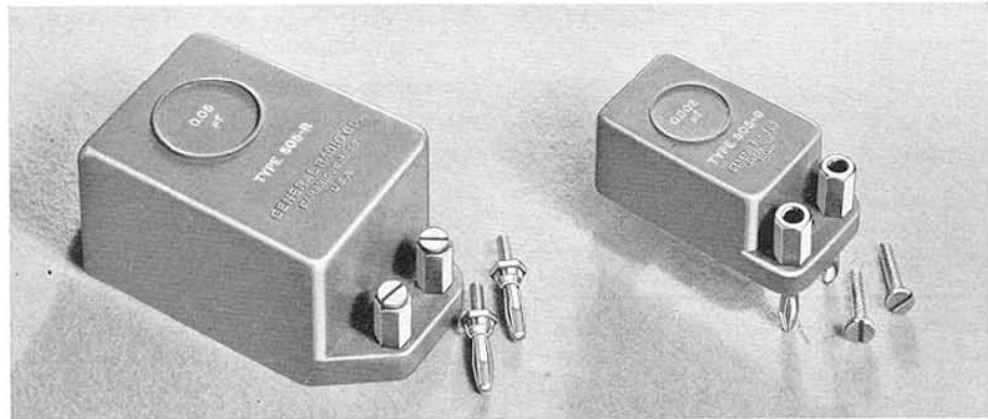

This is a small, handy, mica condenser having low losses and excellent stability of calibration. It is intended to fill the gap between accurately adjusted primary standards on the one hand and the inexpensive moulded types on the other.

India mica was chosen as the dielectric because of its electrical characteristics and a mounting method was developed that makes capacitance practically independent of temperature and power factor independent of humidity. The metal clamp which holds the condenser floats, i.e., is not connected electrically to either condenser terminal.

Every piece of mica is carefully inspected for mechanical defects and other imperfections which cause large dielectric losses. Residual losses are reduced by the use of yellow low-loss bakelite for the cases.

Each condenser is carefully aged and sealed in high-melting-point wax in a low-loss bakelite case.

The plug-type terminals permit these condensers to be stacked in parallel to build up any required value of capacitance.

# CONDENSERS

## SPECIFICATIONS

**Capacitance:** Sizes are available in stock as shown in the price list. (Other sizes can be built to order, prices on request.)

**Accuracy of Adjustment:** See price list.

**Temperature Coefficient:** Less than 0.01% per degree C. between 0° and 50°C.

**Maximum Voltage:** See price list. This rating means that the condenser will safely withstand the a-c voltage whose peak equals the given rating up to the

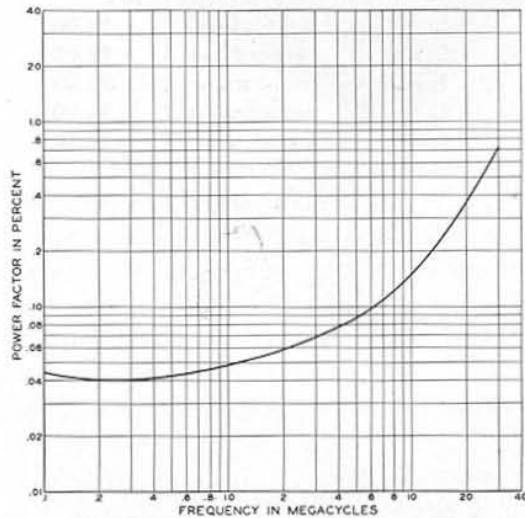
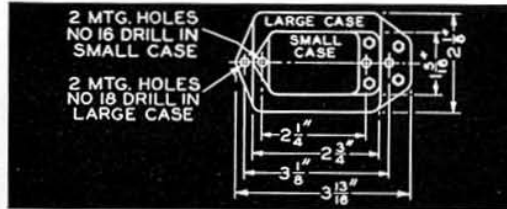

Change in power factor with frequency for a 500  $\mu\text{f}$  condenser

given frequency. Above that frequency, the allowable voltage decreases inversely with the square root of the frequency because of the power loss.

**Power Factor:** Less than 0.05% for frequencies below 2 Mc, except for the three small sizes. Special precautions are taken in assembling and sealing the condensers to insure against change in capacitance or power factor due to varying moisture content of the air and to aging.

**Terminals:** Screw terminals spaced  $\frac{3}{4}$  inch apart. Two TYPE 274-P Plugs are supplied with each condenser so that it may be converted to plug-terminal model.

**Mounting:** Low-loss (yellow) bakelite cases in two sizes as shown in the sketch. TYPES 505-R, 505-T, 505-U, and 505-X take the large case.

**Dimensions:** See sketch.

**Net Weight:** 4 ounces for small, 12 ounces for large size.

Type	Capacitance	Adjusted to Within	Power Factor	Peak Volts	Frequency	Code Word	Price
505-A	100 $\mu\text{f}$	10%	0.1%	700	2000 kc	CONDENALLY	\$3.50
505-B	200 $\mu\text{f}$	5%	0.1%	700	1000 kc	CONDENBELL	3.50
505-E	500 $\mu\text{f}$	2%	0.08%	500	980 kc	CONDENCOAT	3.50
505-F	0.001 $\mu\text{f}$	1%	0.05%	500	800 kc	CONDENDRAM	3.50
505-G	0.002 $\mu\text{f}$	1%	0.05%	500	400 kc	CONDENEYRE	3.50
505-K	0.005 $\mu\text{f}$	1%	0.05%	500	160 kc	CONDENFACT	4.00
505-L	0.01 $\mu\text{f}$	1%	0.05%	500	80 kc	CONDENGIRL	4.50
505-M	0.02 $\mu\text{f}$	1%	0.05%	500	40 kc	CONDENHEAD	5.50
*505-R	0.05 $\mu\text{f}$	1%	0.05%	500	40 kc	CONDENCALM	6.50
*505-T	0.1 $\mu\text{f}$	1%	0.05%	500	20 kc	CONDENCROW	7.50
*505-U	0.2 $\mu\text{f}$	1%	0.05%	500	10 kc	CONDENWIPE	12.00
*505-X	0.5 $\mu\text{f}$	1%	0.05%	500	4 kc	CONDENWILT	20.00

\*Mounted in large case.



## TYPE 219 DECADE CONDENSER

TYPE 219 Decade Condensers are assemblies of two or three TYPE 380 Decade-Condenser Units (see page 40). They are direct reading in capacitance and, while not intended as precise capacitance standards, they are sufficiently accurate for much work of ordinary commercial accuracy. In experimental tuned circuits, in bridge measurements, and in filter design, the wide range combined with the direct-reading feature makes them an extremely useful laboratory accessory.

Both capacitance and power factor will vary slightly with frequency.

In TYPE 219-L and TYPE 219-M Decade Condensers paper dielectric is used in the tenths-microfarad decade. All other decades have mica dielectric.



## SPECIFICATIONS

**Capacitance:** Four decade combinations are available as shown in the price list below.

**Accuracy:** See specifications for TYPE 380 Decade-Condenser Units, page 40. For boxes containing thousandths microfarad decades, allowance must be made for the capacitance of wiring and switches. This value is supplied on the nameplate.

**Maximum Voltage:** See specifications for TYPE 380 Decade-Condenser Units, page 40.

**Power Factor:** See specifications for TYPE 380 Decade-Condenser Units, page 40.

**Mounting:** The decades are assembled on an aluminum panel and mounted in a shielded walnut cabinet.

**Dimensions:** TYPES 219-K and 219-M, (length)  $13\frac{3}{4}$  x (width)  $5\frac{1}{2}$  x (height)  $5\frac{3}{4}$  inches. TYPES 219-L and 219-N, (length)  $10\frac{5}{8}$  x (width)  $5\frac{1}{2}$  x (height)  $5\frac{3}{4}$  inches.

**Net Weight:** TYPE 219-K,  $10\frac{3}{4}$  pounds; TYPE 219-L,  $6\frac{1}{2}$  pounds; TYPE 219-M,  $8\frac{5}{8}$  pounds; TYPE 219-N,  $6\frac{5}{8}$  pounds.

Type	Capacitance	No. of Dials	Type 380 Decades Used	Code Word	Price
219-K	1.110 $\mu$ f in 0.001 $\mu$ f steps	3	F, M, N	CROSS	\$90.00
219-L	1.10 $\mu$ f in 0.01 $\mu$ f steps	2	L, M	COVER	35.00
219-M	1.110 $\mu$ f in 0.001 $\mu$ f steps	3	L, M, N	BRIER	45.00
219-N	0.110 $\mu$ f in 0.001 $\mu$ f steps	2	M, N	CRONY	35.00

## TYPE 380 DECADE-CONDENSER UNIT

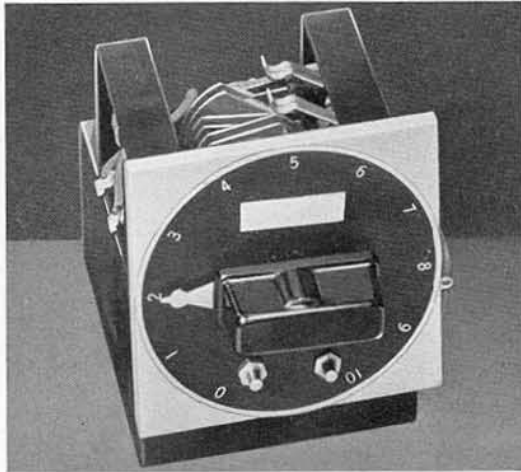

The TYPE 380 Decade-Condenser Unit is an assembly of individual paper or mica condensers and a selector switch arranged so that any one of ten decade values may be chosen. It is made in three individual decade series, each with ten steps of 0.001  $\mu\text{f}$ , 0.01  $\mu\text{f}$ , or 0.1  $\mu\text{f}$ , respectively.

The excellence of these units is due, in large measure, to care in manufacture and aging. Mica units, with the exception of the 1.0  $\mu\text{f}$  decade, are made up of small moulded condensers. The 1.0  $\mu\text{f}$  mica decade uses TYPE 505 Condensers. Paper condensers are thoroughly impregnated

with molten paraffin during winding. Succeeding layers of the conducting foil make contact, thus avoiding the increase in power factor with frequency which occurs when only the ends of the winding are connected.

The switch is of rigid construction and carries a detent mechanism for positive location of switch positions. Contact is made by means of cams bearing on phosphor-bronze springs. A bakelite shaft is used.

### SPECIFICATIONS

**Capacitance:** Decades with steps of 0.001  $\mu\text{f}$ , 0.01  $\mu\text{f}$ , and 0.1  $\mu\text{f}$  are available. Each decade uses four condensers of 1, 2, 3, and 4 units, respectively. These are combined in parallel by the switch to produce the desired capacitance at each switch position.

**Dielectric:** See Table I. The condensers in TYPE 380-M and TYPE 380-N are moulded in bakelite cases. TYPE 380-F is made up of TYPE 505 Condensers (see page 37).

**Maximum Voltage:** See Table I. At higher frequencies the maximum safe voltage decreases and is inversely proportional to the square root of the frequency.

**Power Factor:** See Table I.

**Calibration Accuracy:** See Table I.

TABLE I

Type	Capacitance	Accuracy	Dielectric	Power Factor	Maximum Voltage at Frequency
380-F	1.0 $\mu\text{f}$ in 0.1 $\mu\text{f}$ steps	1%	Mica	0.05%	500 4 kc
380-L	1.0 $\mu\text{f}$ in 0.1 $\mu\text{f}$ steps	2%	Paper	1.0%	300 1 kc
380-M	0.1 $\mu\text{f}$ in 0.01 $\mu\text{f}$ steps	1%	Mica	0.1%	300 100 kc
380-N	0.01 $\mu\text{f}$ in 0.001 $\mu\text{f}$ steps	1%	Mica	0.2%	300 1000 kc

**Accessories:** One TYPE 202-Z Knob and one TYPE 380-93 Dial Plate are supplied.

**Mounting:** Machine screws for attaching the decade to a panel are supplied.

**Dimensions:** TYPE 380-F, panel space,  $4\frac{3}{4} \times 4\frac{1}{4}$

inches; behind panel, 4 inches. TYPES 380-L, 380-M, and 380-N, panel space,  $2\frac{7}{8} \times 3\frac{3}{8}$  inches; behind panel,  $4\frac{1}{8}$  inches.

**Net Weight:** TYPE 380-F, 3 pounds, 10 ounces; TYPES 380-L and 380-M,  $1\frac{1}{2}$  pounds; TYPE 380-N, 1 pound, 6 ounces.

Type	Code Word	Price
380-F	ACUTE	\$58.00
380-L	ADAGE	10.00
380-M	ADDER	12.00
380-N	ADDLE	10.00

TYPE 106 STANDARD INDUCTANCE

This fixed standard is accurately adjusted at 1000 cycles. Low and nearly constant resistance at audio frequencies is insured by the use of stranded wire having the separate strands insulated from each other.

Interaction between the field of the inductor and external fields is practically eliminated by the use of an astatic form of winding in which the fields of two coil sections neutralize each other in regions external to the case. This makes the inductance independent of surroundings. Conversely, disturbing voltages induced by an external field will practically cancel out in the two halves of the coil.

Coils are form wound, bound with tape, and impregnated with wax. There is no metal in the concentrated field of the coil.



TYPE 106-L Standard Inductance

SPECIFICATIONS

**Inductance Calibration:** The 0.1 mh size is adjusted to within 0.2%, all others to within 0.1% of their labeled values at 1000 cycles.

**Resistance:** Resistance at 1000 cycles is the same as the d-c resistance, the value of which, measured at room temperature, is entered on a certificate mounted on the bottom of the cabinet. See table below for approximate values.

**Temperature Coefficient:** The temperature coefficient is less than  $\pm 0.004\%$  per degree C.

**Maximum Current:** See table.

**Losses:** The maximum value of the energy factor  $Q (= \frac{X}{R})$  and the frequency for which it occurs for

each size are given in the table.

**Frequency Error:** Disregarding skin effect the fractional change in inductance with frequency is  $f^2/f_0^2$  where  $f$  is operating frequency and  $f_0$  the natural frequency. At one-tenth the natural frequency, therefore, the error is 1%.

**Mounting:** All units are assembled in walnut cabinets with bakelite panels.

**Dimensions:** Panel,  $5\frac{7}{8}$  x  $5\frac{7}{8}$  inches. Cabinet, (height)  $3\frac{1}{2}$  inches, over-all, except TYPE 106-M which is  $5\frac{5}{8}$  inches, over-all.

**Net Weight:** Approximately  $2\frac{5}{8}$  pounds, except TYPE 106-M which is 5 pounds.

Type	Nominal D-C Resistance	Maximum Current	Maximum Q	Frequency for Maximum Q	Natural Frequency
106-L	0.18 $\Omega$	3.5 a	210	300 kc	6000 kc
106-G	1.80 $\Omega$	1.0 a	190	150 kc	2000 kc
106-J	12.2 $\Omega$	0.5 a	170	60 kc	500 kc
106-K	85.3 $\Omega$	250 ma	80	20 kc	150 kc
106-M	545 $\Omega$	150 ma	40	7 kc	35 kc

Type	Inductance	Code Word	Price
106-L	0.1 mh	INNER	\$25.00
106-G	1 mh	INERT	25.00
106-J	10 mh	IRATE	25.00
106-K	100 my	ISLET	25.00
106-M	1 henry	ISSUE	30.00

## TYPE 107 VARIABLE INDUCTOR

A continuously variable calibrated inductor is a necessary adjunct to many kinds of electrical measurements. TYPE 107 Variable Inductors are high-grade laboratory instruments suitable for use as inductance standards of moderate accuracy. Their outstanding features are direct-reading dials, permanence of construction, low losses, and high current-carrying capacity.

Separate terminals are brought out for rotor and stator so that they may be connected in series or in parallel as a self-inductor, or used separately as a mutual inductor. The inductances of rotor and stator have been carefully equalized to eliminate losses from circulating currents when the parallel connection is used.



### SPECIFICATIONS

**Inductance Range:** Five sizes are available in stock covering a total range of approximately 1.7  $\mu$ h to 500 mh by the use of both the series and parallel connections. Maximum and minimum values for each connection are shown in the table below.

**Calibration:** The inductance for the series connection, accurate to within 1% of full-scale reading at 1000 cycles, is engraved on the dial. The inductance with the parallel connection is one-quarter that for the series connection to within 0.1%. Data for computing the mutual inductance are supplied on the nameplate.

**Losses:** The maximum value of the factor  $Q (= \frac{X}{R})$  at full-scale setting for the series connection and the frequency at which it occurs for each size are given in the table below.

**Natural Frequency:** See table below.

**Maximum Current:** The maximum allowable current for a dissipation of 15 watts and temperature rise of 40°C. (series connection) is engraved on each nameplate. See table for a list of values.

Type	D-C Resistance	Maximum Current	Maximum* Q	Frequency for* Maximum Q	Natural* Frequency
107-J	0.17 $\Omega$	8.5 a	110	400 kc	5000 kc
107-K	0.7 $\Omega$	4.0 a	140	200 kc	1500 kc
107-L	4.8 $\Omega$	1.7 a	125	60 kc	500 kc
107-M	40 $\Omega$	0.60 a	65	20 kc	150 kc
107-N	660 $\Omega$	0.14 a	20	7 kc	30 kc

\*For full-scale setting, series connection.

**Mounting:** All units are mounted on bakelite panels and enclosed in walnut cabinets.

**Dimensions:** 6½ x 6½ x 8¾ inches, over-all.

**Net Weight:** 5 pounds, all ranges.

Type	Self-Inductance		Mutual Inductance	Code Word	Price
	Series	Parallel			
107-J	7- 50 $\mu$ h	1.7-12.5 $\mu$ h	0-10.8 $\mu$ h	HAREM	\$35.00
107-K	60-500 $\mu$ h	15-125 $\mu$ h	0-110 $\mu$ h	HARPY	35.00
107-L	0.6- 5 mh	0.15-1.25 mh	0-1.1 mh	HARRY	35.00
107-M	6- 50 mh	1.5-12.5 mh	0-11 mh	HOTEL	40.00
107-N	60-500 mh	15-125 mh	0-110 mh	HOVER	40.00

PATENT NOTICE. See Note 17, page v.



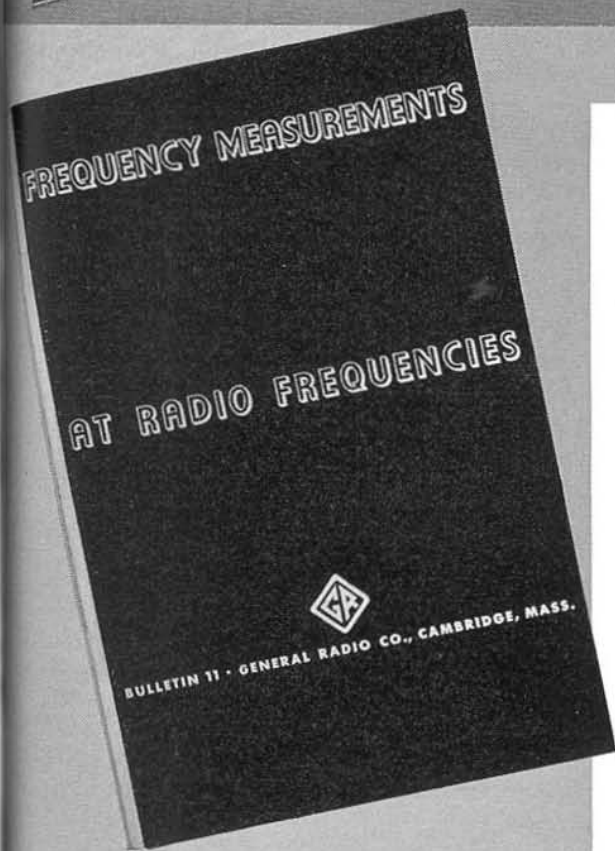
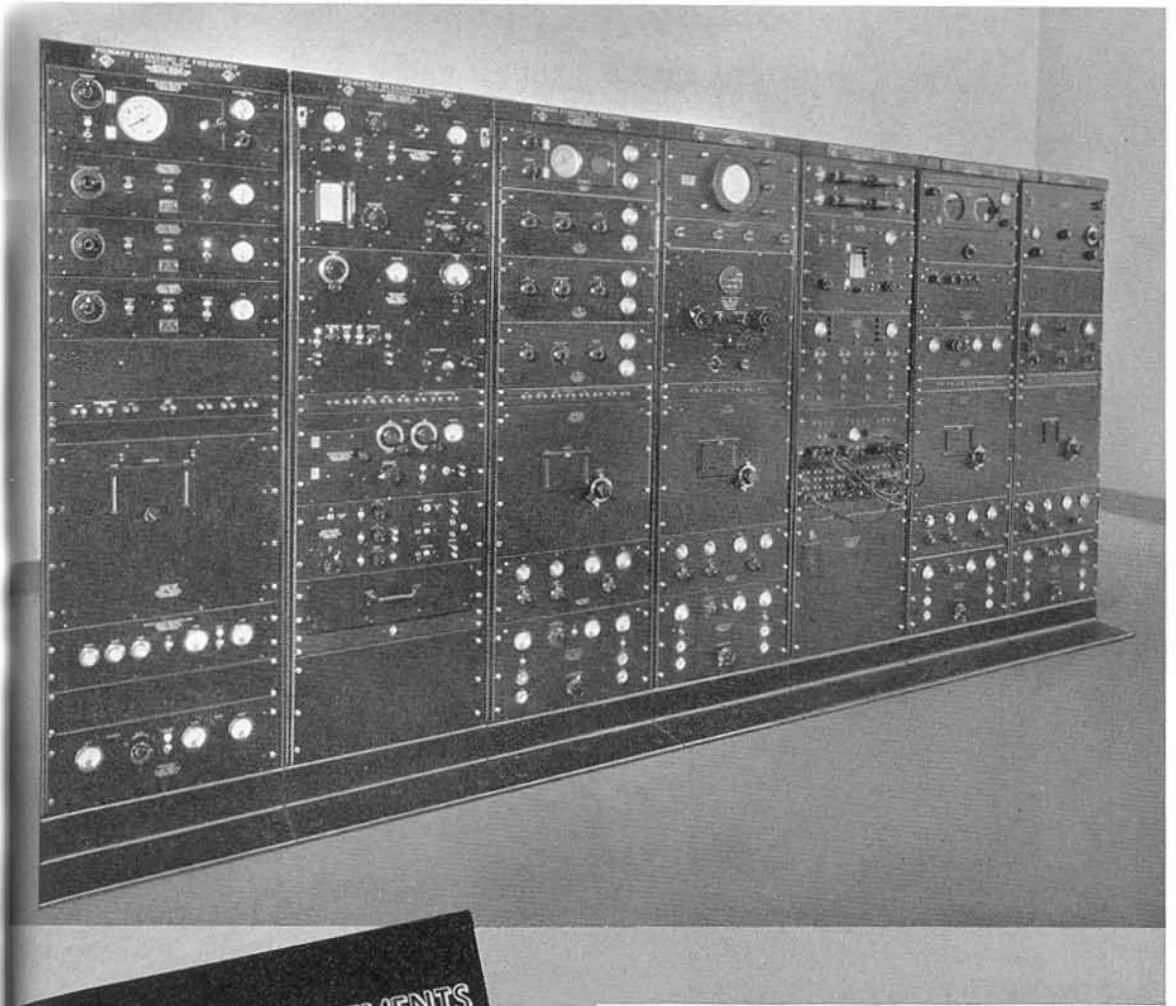

## FREQUENCY- AND TIME- MEASURING EQUIPMENT

The measurement of frequency and time is a specialized field, and a description of instruments for measuring these quantities requires a considerable amount of background material. For this reason, the General Radio Company publishes Bulletin 11, entitled "Frequency Measurements at Radio Frequencies," in which is described in detail a complete line of frequency-measuring equipment. The brief listings given on pages 44 to 52 of this catalog indicate the types of instruments available.

Those interested in the measurement of frequency are urged to send for a copy of Bulletin 11.

CLASS C-21-H STANDARD-FREQUENCY ASSEMBLY  
(SERIES 690)

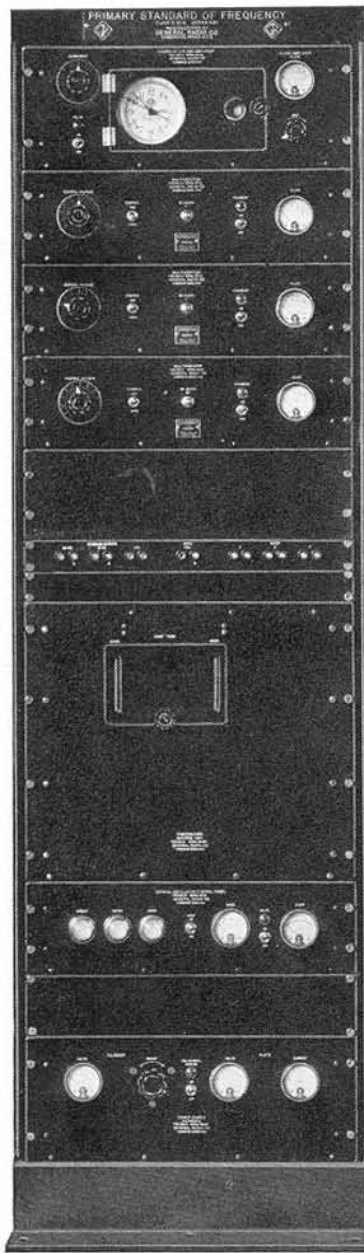

**Net Weight:** 370½ pounds for floating-battery assembly, 352¾ pounds for completely a-c operated assembly, relay rack included.

The Class C-21-H Standard-Frequency Assembly is a complete and highly precise primary standard of frequency. It is also a crystal-controlled clock of high precision. More than 60 units have been installed and are now operating in all parts of the world in industrial organizations, research laboratories, observatories, and frequency monitoring stations. Many of them are used as national standards of frequency by communications administrations in North American, European, and Asiatic countries.

The assembly is provided with a means of measuring its output frequencies in terms of standard time without reference to any other standard of frequency. Harmonic series based on fundamentals of 1, 10, and 50 kilocycles are available at its output terminals to furnish standard frequencies over the entire communication-frequency spectrum. From it can also be obtained one-second pulses and standard time. The accuracy of all output frequencies is better than ±5 parts in 10 million over periods of several months. Each of the output frequencies is known with the same accuracy.

The assembly is furnished with either of two types of power supply. If line failure is rare, or if certainty of continuous timing is not demanded, the TYPE 696-A Power Supply operates the assembly satisfactorily. The TYPE 695-A Battery Charging Equipment furnishes filament and plate power to operate the complete assembly and maintains a full charge on floating batteries which will supply emergency power. Prices include vacuum tubes and interconnecting cables. The price of the floating battery assembly does not include the batteries.

**SPECIFICATIONS**

**Frequency Range:** Harmonic frequencies between 1 kc and 30 Mc, seconds pulses, and standard time are the available outputs.

**Stability:** 5 parts in 10 million or better.

**Power Supply:** Either floating batteries charged from the a-c line or direct operation from the line.

**Mounting:** Standard 19-inch relay rack. Interconnecting cables and plugs are supplied.

**Dimensions:** (Height) 69½ x (width) 20 x (depth) 24 inches, over-all.

<i>Description</i>	<i>Code Word</i>	<i>Price</i>
Assembly for operation from floating batteries . . . . .	LYRIC	\$2175.00
Assembly for complete a-c operation . . . . .	LAYER	2100.00

PATENT NOTICE. See Notes 1, 3, 8, 12, 14, 19, 20, page v.

THIS EQUIPMENT IS COMPLETELY DESCRIBED IN BULLETIN 11

# FREQUENCY MEASURING EQUIPMENT

## INTERPOLATION AND AUXILIARY EQUIPMENT FOR USE WITH CLASS C-21-H STANDARD-FREQUENCY ASSEMBLY

This interpolation and auxiliary equipment used in conjunction with a CLASS C-21-H Standard-Frequency Assembly makes possible the direct precision measurement of any radio frequency up to 25,000 kc. For frequencies above 25,000 kc, measurements can be made with almost equal ease by utilizing heterodyne methods.

### TYPE 616-B HETERODYNE FREQUENCY METER

A calibrated, oscillating, frequency meter with detector and audio amplifier. The oscillator has a voltage-stabilized circuit and is temperature controlled. Range 100 to 5000 kc. It is used either as an interpolation device or to transfer the unknown frequency to a local strong oscillator.

Code Word: MANOR

Price: \$575.00

### TYPE 617-B INTERPOLATION OSCILLATOR

A 0-5000-cycle, direct-reading, linear-scale oscillator with an accuracy of  $\pm 2$  cycles. Used to measure beat frequencies between an unknown frequency and a standard 10-kc harmonic.

Code Word: MAPLE

Price: \$500.00

### TYPE 619-C HETERODYNE DETECTOR

This unit, a tuned regenerative detector, combines the standard and unknown frequencies, producing an audio-frequency-output signal of between 0 and 5000 cycles which is then fed to the TYPE 617-B Interpolation Oscillator for measurement.

Code Word: MATIN

Price: \$250.00

### TYPE 612-B COUPLING PANEL

This unit is the central control panel of the auxiliary equipment. The switches permit the interconnections necessary for a complete frequency measurement.

Code Word: MARRY

Price: \$65.00

### TYPE 614-A SELECTIVE AMPLIFIER

For central installations to supply many laboratories, the selective amplifier provides exact one-kilocycle multiples between 1 kc and 10 kc for timing, testing, and calibration purposes.

Code Word: DICKY

Price \$275.00

### SPECIFICATIONS

(Specifications for each instrument will be found in Bulletin 11.)

**Power Supply:** 110-115 volts, 50-60 cycles.

**Mounting:** TYPE 480-A Relay Rack priced at \$40.00. Blank panels to fill rack as shown are priced at \$7.25.

**Dimensions:** (Height)  $69\frac{1}{2}$  x (width) 20 x (depth) 18 inches, over-all.

**Net Weight:** 205 $\frac{1}{4}$  pounds.

**Price:** Includes relay rack, blank panels, and cables for interconnections.

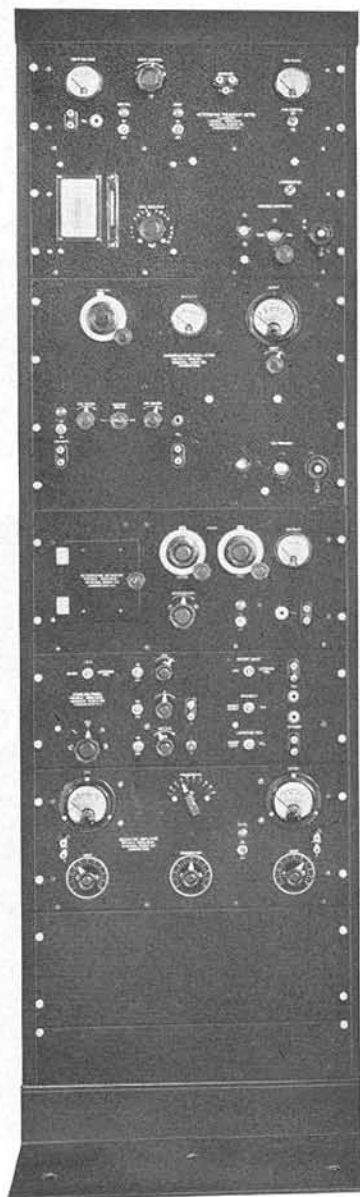

Price

Interpolation and Auxiliary Equipment as illustrated .....

\$1712.25

PATENT NOTICE. See Notes 1, 3, 10, 14, 17, page v.

CONSULT BULLETIN 11 FOR COMPLETE DETAILS

CLASS C-10 STANDARD-FREQUENCY ASSEMBLY

The secondary standard is widely used in frequency measurements where the reliability and extreme precision of a primary standard are not essential. The Class C-10 Standard Frequency Assembly consists of a highly stable, temperature-controlled piezo-electric oscillator and one multivibrator. Additional multivibrators up to a total of three can be added, if desired. As ordinarily supplied, the multivibrator operates at 10 kilocycles. The quartz bar may be either 50 kc or 100 kc. The 50-kc bar is recommended because of its greater stability. The assembly is completely a-c

operated and is composed of the following instruments:

Unit	See Page
TYPE 675-L Piezo-Electric Oscillator	Below
TYPE 692-A Multivibrator (10 kc)	Below
TYPE 676-A Quartz Bar (50 kc) or	51
TYPE 476-A Quartz Bar (100 kc) with	
TYPE 476-P1 Mounting	51
TYPE 480-B Relay Rack	146

Type	Code Word	Price
Class C-10 With 50-kc Quartz Bar	EPOCH	\$615.00
Class C-10 With 100-kc Quartz Bar	EPODE	585.00

PATENT NOTICE. See Notes 1, 3, 8, 12, 14, 17, 19, 20, page v.

TYPE 675-L PIEZO-ELECTRIC OSCILLATOR

This oscillator, used in conjunction with a TYPE 476-A or a TYPE 676-A Quartz Bar is the frequency-standard unit in the Class C-10 Standard Frequency Assembly. It includes an a-c power supply capable of supplying filament and plate power to a maximum of three multivibrators.

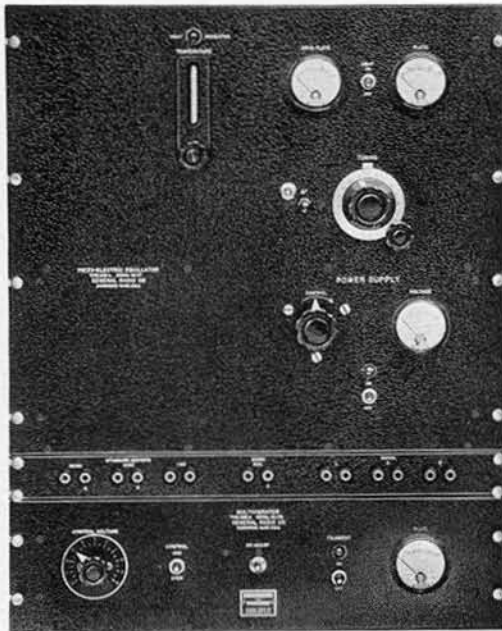

Type	Code Word	Price
675-L	AWAIT	\$315.00

PATENT NOTICE. See Notes 1, 3, 12, 14, 17, 19, 20, page v.

TYPE 692-A MULTIVIBRATOR

The multivibrator is used as a frequency divider and harmonic generator in General Radio standard-frequency assemblies. It is available in stock for frequencies of 1, 10, and 50 kilocycles.

Type	Frequency	Code Word	Price
692-A	1 kc	STANFREANT	\$140.00
692-A	10 kc	STANFREBOY	140.00
692-A	50 kc	STANFRECAT	140.00

PATENT NOTICE. See Note 1, page v.

THIS EQUIPMENT IS COMPLETELY DESCRIBED IN BULLETIN 11



VISUAL-TYPE FREQUENCY MONITOR FOR RADIO BROADCASTING STATIONS

This monitor is intended for monitoring broadcast transmitters operating within a 50-cycle frequency tolerance where government regulations require a visual indication of the frequency deviation. It has been approved by the Federal Communications Commission (Approval No. 1452) and is used in hundreds of stations in the United States and foreign countries.

The frequency indicator is a large meter with a range of -100 to +100 cycles. The monitor is a-c operated and consists of: TYPE 475-A Frequency Monitor, TYPE 681-A Frequency Deviation Meter, and TYPE 376-L Quartz Plate.

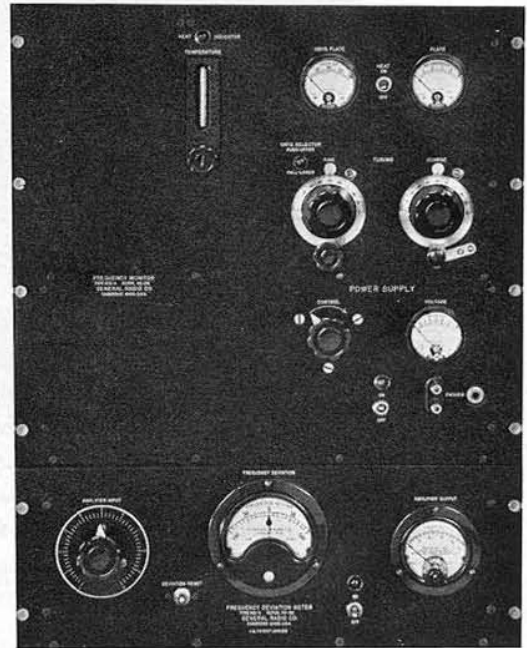

Type	Code Word	Price
Visual-Type Frequency Monitor	DEVOR	\$560.00

PATENT NOTICE. See Notes 1, 3, 7, 12, 17, 19, 20, page v.

TYPE 475-A FREQUENCY MONITOR

TYPE 475-A Frequency Monitor is the reference standard, detector, audio amplifier, and a-c power supply for the visual-type frequency monitor described above. It can be used for monitoring by the audible beat method or, in conjunction with a TYPE 681-A or TYPE 682-A Fre-

quency Deviation Meter, by the visual method. A TYPE 376-L Quartz Plate is also required (see page 50).

Type	Code Word	Price
475-A	MOGUL	\$330.00

PATENT NOTICE. See Notes 1, 3, 12, 17, 19, 20, page v.

TYPE 681-A FREQUENCY DEVIATION METER

This instrument consists of an audio amplifier and a visual-type frequency meter. It is intended for use in monitoring radio broadcasting stations. The range is from -100 cycles to +100 cycles, frequency deviation. Power supply is ob-

tained from the TYPE 475-A Frequency Monitor.

Type	Code Word	Price
681-A	MASON	\$145.00

PATENT NOTICE. See Notes 1, 7, page v.

TYPE 682-A FREQUENCY DEVIATION METER



A frequency deviation meter with two ranges, 0 to 1000 cycles and 0 to 5000 cycles. Power supply is obtained from the TYPE 475-A Frequency Monitor.

Type	Code Word	Price
682-A	MISTY	\$145.00

PATENT NOTICE. See Note 24, page v.

CONSULT BULLETIN 11 FOR COMPLETE DETAILS

TYPE 615-A HETERODYNE FREQUENCY METER



The TYPE 615-A Heterodyne Frequency Meter is an oscillating type of frequency meter designed for use in the measurement of frequency by heterodyne methods. Although its tuned circuit is subject to slight drifts in frequency due to temperature and aging effects, it can be checked against a local frequency standard or standard-frequency radio signals for measurements of high accuracy.

It consists of a highly stable vacuum-tube oscillator and a detector. It is portable, operating from self-contained batteries, which are not supplied.

SPECIFICATIONS

**Range:** 275 to 5000 kc.

**Accuracy:** 0.2% if a correction is made for the difference between calibrating and operating temperatures.

**Tubes:** The necessary tubes are supplied.

**Power Supply:** Self-contained batteries.

**Mounting:** Portable carrying case.

**Dimensions:** (Length) 19½ x (width) 8 x (height) 13½ inches, over-all.

**Net Weight:** 34 pounds.

Type	Code Word	Price
615-A	MANLY	\$375.00

PATENT NOTICE. See Notes 1, 3, page v.

TYPE 675-H PIEZO-ELECTRIC OSCILLATOR

This oscillator is similar in general construction to the TYPE 675-L instrument described on page 46. The oscillator circuit, however, is designed for use at high frequencies as well as low and will operate at any frequency between 100 and 4000 kc, depending on the frequency of the TYPE 376 Quartz Plate used. An a-c power supply and two output amplifiers are included.

SPECIFICATIONS

**Accuracy:** See specifications for TYPE 376-L Quartz Plate, page 50.

**Power Supply:** 115 volts, 50-60 cycles.

**Mounting:** Standard 19-inch relay rack.

**Dimensions:** Panel, (width) 19 x (height) 17½ inches. Behind panel, (depth) 10¾ inches.



**Net Weight:** 65 pounds.

Type	Code Word	Price
675-H	AVOWD	\$315.00*

\*Price includes vacuum tubes but does not include quartz plate.  
PATENT NOTICE. See Notes 1, 3, 12, 17, 19, 20, page v.

THIS EQUIPMENT IS COMPLETELY DESCRIBED IN BULLETIN 11

TYPE 620-A HETERODYNE FREQUENCY METER  
AND CALIBRATOR

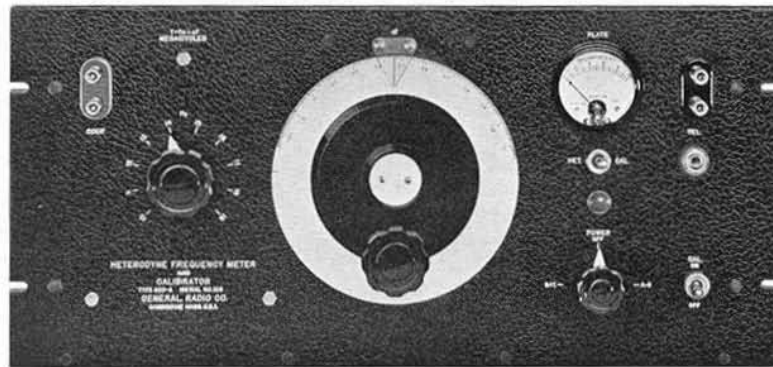

The TYPE 620-A Heterodyne Frequency Meter and Calibrator is designed for measuring high and ultra-high frequencies. It consists of a heterodyne frequency meter and a low-temperature coefficient piezo-electric oscillator.

The frequency meter fundamental is variable between 10 and 20 megacycles. This range is divided into ten parts, selected by a switch, and each band covers one megacycle. The frequency-control dial is calibrated directly in fractions of a megacycle. The fundamental frequency, in megacycles, is given by the sum of the coil switch reading and the condenser dial reading.

To measure frequencies below and above the fundamental range, harmonic methods are used. For checking the calibration, a strong crystal harmonic falls at each end of the dial for every range, and weaker harmonics occur at intermediate settings.

A detector and audio amplifier are provided for obtaining beats.

A power supply, operating from a 115-volt, 60-cycle, a-c line, is included. Provision is also made for connections to battery supply.

SPECIFICATIONS

**Frequency Range:** The fundamental frequency range is from 10 to 20 megacycles, in 10 ranges of 1 megacycle each. By harmonic methods frequencies between 300 kilocycles and 300 megacycles are easily measured.

**Calibration:** The condenser dial is graduated to read fractions of megacycles directly, the smallest division corresponding to 0.005 megacycle (5000 cycles). Fifths of divisions are readily estimated, corresponding to 0.001 megacycle (1000 cycles).

**Calibrator:** A one-megacycle piezo-electric oscillator, employing a low-temperature coefficient quartz plate, is provided for checking the calibration of the heterodyne frequency meter.

**Accuracy:** The over-all accuracy of measurement is 0.01% or better.

**Power Supply:** Either 105-125 volts 50-60 cycles, or 6 and 180 volts dc.

**Power Input:** 15 watts; from 115-volt 60-cycle supply.

**Mounting:** The instrument is supplied either for relay-rack mounting or in a portable cabinet.

**Accessories:** A battery plug is supplied with the relay-rack model, a plug and cable with the cabinet model. All vacuum tubes are supplied.

**Dimensions:** Rack-mounted model, panel, (length) 19 x (height) 8 $\frac{3}{4}$  inches; behind panel, (length) 17 $\frac{1}{4}$  x (height) 8 $\frac{3}{8}$  x (depth) 10 $\frac{3}{4}$  inches; cabinet model, 20 $\frac{1}{2}$  x 14 $\frac{1}{2}$  x 10 inches, over-all.

**Net Weight:** Rack-mounted model, 40 pounds; cabinet model, 45 pounds.

Type	Description	Code Word	Price
620-AR	Relay-Rack Mounting .....	DAISY	\$490.00
620-AM	Cabinet Mounting .....	DALLY	555.00

PATENT NOTICE. See Notes 1, 12, 20, page v.

## TYPE 376-L QUARTZ PLATE



This is a low-temperature-coefficient piezo-electric quartz plate for operation with a General Radio piezo-electric oscillator as a standard of frequency in laboratory measurements or in a frequency-monitoring installation. Since the high order of frequency stability required in such services is not compatible with high power output from the oscillator, the frequencies of all plates are guaranteed for operation only at a low power level.

TYPE 376-L Quartz Plates are not sold for direct frequency control of radio transmitters.

The frequency is adjusted very closely to the ordered frequency and it is guaranteed to be accurate to within a very few parts in a million. The accuracy is sufficient for monitoring any class of radio-telephone or -telegraph service, including broadcasting.

All plates are manufactured from high grade, piezo-electric quartz, free from twinning. The plates are cut by modern optical manufacturing methods, and the parallelism of the surfaces and their orientations with respect to the crystallographic axes are held to extremely small tolerances.

TYPE 376-L Quartz Plate is so cut that the temperature coefficient is extremely low, being less than 3 parts per million per degree Centigrade.

The General Radio Company's guarantee of accuracy of frequency becomes void when other types of holders or oscillators are used, or other temperature ranges are tolerated, than those named in the accompanying detailed specifications. This policy insures a known reliability of performance and permits a much closer accuracy guarantee than would otherwise be possible.

The TYPE 376 Quartz Plate holder supplied is designed to maintain the greatest stability of the oscillator frequency. The holder is of the air-gap type, with a sealed electrode-spacing adjustment and an isolantite base. The quartz plate is held securely so that changes in orientation or mechanical jars will not shift the frequency. The method of mounting allows the plate to vibrate freely but restricts random motion or appreciable changes in position. The holder is intended for use with the base in a horizontal position.

Two TYPE 274-P Plugs, set on standard  $\frac{3}{4}$ -inch spacing, give plug-in mounting in General Radio oscillators or temperature-control boxes.



## SPECIFICATIONS

**Frequency Range:** Plates can be made for any frequency in the range between 450 kc and 4000 kc.

**Accuracy of Adjustment:** The frequency of the plate is adjusted until it differs in our laboratory from the ordered frequency by less than one cycle per second or 0.0001%, whichever is smaller.

**Accuracy of Calibration:** After the frequency of the plate has been adjusted as described in the preceding paragraph, the frequency is accurately measured in terms of standard frequencies from a General Radio Class C-21-H Standard-Frequency Assembly and the result of this measurement is entered in the calibration certificate.

**Certified Accuracy:** When operated under conditions specified in the calibration certificate, the accuracy is guaranteed to be within 0.002% (20 parts per million) of the frequency ordered for a period of one year.

**Temperature Coefficient:** The temperature coefficient of frequency is less than 3 parts per million per degree Centigrade between 20 degrees and 70 degrees

(68° and 158° F.) Centigrade.

**Oscillator:** Since the frequency and the frequency stability of a piezo-electric frequency standard depend upon the design and construction of the oscillator, the performance of all General Radio quartz plates is specified in a given type of oscillator.

The frequency is guaranteed in any General Radio piezo-electric oscillator designed for use with TYPE 376-L Quartz Plates. When other oscillators are used, the plate must be calibrated in the oscillator with which it is to be used. Operating temperature and voltages are specified in the calibration certificate.

**Mounting:** The crystal holder consists of an isolantite base carrying an aluminum cap with a means for adjusting, locking, and sealing the air gap. It is practically dust proof and is fitted with plugs for use in General Radio piezo-electric oscillators.

**Dimensions:** Base, (length)  $2\frac{3}{4}$  x (width) 2 x (height)  $1\frac{1}{2}$  inches, over-all.

**Net Weight:** 10 ounces.

Type	Code Word	Price
376-L	NEVER	\$85.00
Credit allowance for returned TYPE 376 Quartz Plates, Serial No. 2000 and higher		10.00

PATENT NOTICE. See Note 12, page v.

## TYPE 676-A AND TYPE 476-A QUARTZ BARS

These quartz bars are intended for use in standard-frequency assemblies. The 50-kc unit is supplied as standard equipment with the Class C-21-H Assembly, and its use is optional in the Class C-10 Assembly.

The mounting has been designed to have a minimum of effect on the frequency of the bar. Electrodes are deposited directly on the quartz, thus eliminating the effect of air gaps. Baffles are provided to eliminate the effects of high-frequency sound energy radiated from the ends of the bar. The bar is zero-angle cut. The temperature coefficient is less than 2 parts per million per degree C.

The 100-kc bar resembles the 50-kc bar in general construction but the TYPE 476-A Quartz Bar is mounted in a plug-type case similar to the ones in which TYPE 376-L Quartz Plate is mounted.

A TYPE 476-P1 Adapter is required when a TYPE 476-A Quartz Bar is to be mounted in a Class C-10 or in a Class C-21-H Standard-Frequency Assembly.

Type	Frequency	Code Word	Price
676-A	50 kc	PIEZOMUSHY	\$145.00
476-A	100 kc	MOCHA	95.00
476-P1	Adapter	ADAPTORCOP	20.00

PATENT NOTICE. See Notes 8, 12, page v.

TYPE 747-A TEMPERATURE-CONTROL BOX



This instrument is designed for use in controlling the temperature of quartz plates in order to assure constant frequency.

A terminal plate carrying two sets of jacks for TYPE 376 Quartz Plates is provided within the temperature-controlled space. The operation of a switch from the front of the panel connects either pair of jacks to the external connections, thus allowing quartz plates for two separate frequencies to remain at their operating temperatures and ready for immediate use.

Interleaved heaters and distributing and insulating layers formed of aluminum and balsa wood, respectively, form the walls of the temperature-controlled space. They maintain the air temperature of the quartz plate chamber constant to within  $\pm 0.1^\circ\text{C}$ . for external temperature variations of  $\pm 16^\circ\text{C}$ . ( $\pm 29^\circ\text{F}$ ).

A thermometer, graduated in  $0.5^\circ\text{C}$ . divisions from  $40^\circ$  to  $60^\circ\text{C}$ ., is mounted behind a slot in the panel and is illuminated by the heat-control indicating lamp. This thermometer indicates the air temperature of the inner space.

The thermostat is of the fixed mercury type and is normally supplied for operation at  $50^\circ\text{C}$ . Thermostats for operation at other temperatures that are called for by the manufacturer of the quartz plate used can be supplied when ordered.

This instrument can be supplied mounted in a cabinet or on a standard 19-inch relay-rack panel. When supplied for relay-rack mounting, space is available at the right of the temperature-control box for the construction of oscillator circuits or for other associated circuit elements. The leads from the quartz plate are brought out at the right-hand side of the box, making it convenient to attach leads to other circuits and at the same time reducing the length of leads necessary.

The power supply is a 115-volt line, either ac or dc. A plug and cord for connecting the instrument to the 115-volt line are provided.

SPECIFICATIONS

**Accuracy of Temperature Control:** The unit will control the temperature of the inner space to within  $\pm 0.1^\circ\text{C}$ . for changes in room temperature of  $\pm 16^\circ\text{C}$ . ( $29^\circ\text{F}$ .) Where the crystal is operated at a power level so high that it generates heat, the temperature can be held to within the same limits if the heat generated by the crystal remains constant.

**Operating Temperature:** Normally  $50^\circ\text{C}$ ., but other temperatures can be supplied on special order.

**Mounting:** Two types of mounting can be supplied,

a walnut cabinet or a standard 19-inch relay-rack panel. (See price list below.)

**Dimensions:** TYPE 747-AM, (width)  $13\frac{1}{4}$  x (height)  $11\frac{5}{8}$  x (depth)  $13\frac{1}{2}$  inches, over-all.

TYPE 747-AR, (width) 19 x (height)  $10\frac{1}{2}$  x (depth)  $12\frac{5}{8}$  inches, over-all.

The inside dimensions of the temperature-controlled space are those of a  $4\frac{1}{8}$ -inch cube.

**Net Weight:** TYPE 747-AM,  $31\frac{3}{4}$  pounds; TYPE 747-AR, 29 pounds.

Type	Description	Code Word	Price
747-AM	Cabinet Mounting . . . . .	BURLY	\$150.00
747-AR	Relay-Rack Mounting . . . . .	BATHE	150.00

PATENT NOTICE. See Note 19, page v.

## TYPE 815-A PRECISION FORK

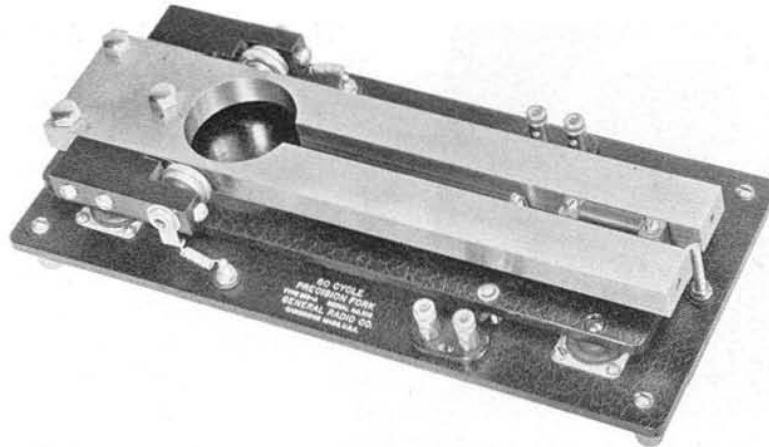

TYPE 815-A Precision Fork is designed for such uses as timing in geophysical exploration, in rating clocks and watches, in synchronizing facsimile transmission, and in low-frequency standardization. It combines high accuracy and stability with simplicity of construction and operation.

The fork is made of a low-temperature coefficient steel alloy. It is mounted at the heel on a metal panel which is attached to the main base by means of rubber shock absorbers to reduce energy dissipation through the mounting.

One microphone button is mounted on each tine near the heel of the fork, where the amplitude of vibration is low. This minimizes the damping action which the presence of the microphones exerts on the fork. At the end of each tine, adjusting screws are provided. By means of these, the loading on the tines is equalized. This factor, too, is important in reducing the decrement.

Separate microphone buttons are used for the driving and output circuits. No output filter or transformer is included, since different uses may require different circuit arrangements.

A 50-cycle model is carried in stock. Forks for other frequencies between 40 and 200 cycles per second can be built to order.

## SPECIFICATIONS

**Frequency:** 50 cycles per second. Forks can, however, be supplied at any frequency between 40 and 200 c.p.s.

**Calibration:** The frequency is adjusted within 0.005% of rated value. The calibration temperature is supplied.

**Frequency Stability:** The over-all stability is better than 0.01% under normal room-temperature conditions.

**Temperature Coefficient:** The temperature coefficient of frequency is negative and less than 10 parts per million (0.001%) per degree F.

**Voltage Coefficient:** The voltage coefficient of frequency is positive and less than 150 parts per million per volt (0.015%).

**Power Supply:** A 6-volt battery is used as the driving source. Driving current is less than 50 milliamperes.

**Output:** The power output is approximately 50 milliwatts. The impedance of the output microphone is 50 ohms.

**Mounting:** The fork assembly is mounted on a metal base for table or bench use.

**Dimensions:** 13 x 6 x 3 inches, over-all.

**Weight:** 8 pounds.

Type	Frequency	Code Word	Price
815-A	50 cycles	FAUNA	\$150.00

## TYPE 434-B AUDIO-FREQUENCY METER

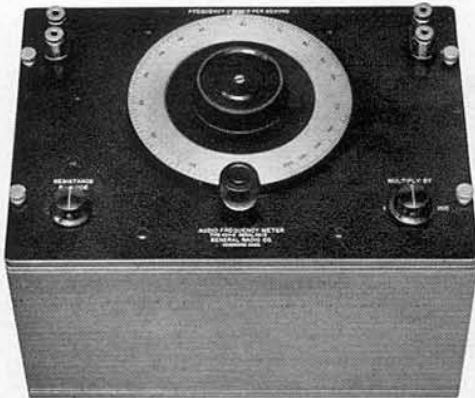

The TYPE 434-B Audio - Frequency Meter provides a means of measuring, with an accuracy of 0.5 per cent, audio frequencies between 20 and 20,000 cycles per second. The circuit is that of the Wien bridge, which contains only resistances and capacitances. This avoids the magnetic pickup which exists in frequency meters containing inductance and also makes possible the use of a logarithmic scale, obtained by suitably tapering the variable resistance elements.

The null detector is usually a pair of high-resistance head telephones. They are sufficiently sensitive to enable the dial to be set to 0.5 per cent with two volts input to the bridge within the frequency range 300-3000 cycles, if the waveform is pure. The dial may be set to 0.1 per cent by applying a higher voltage to the bridge or by using an amplifier such as the TYPE 814-A Amplifier between the bridge and the telephones. When the harmonic content of the supply is large, a low-pass filter, such as TYPE 830 Filter Sections, or a tuned circuit may be used for frequencies less than the natural frequency of the telephones (about 900 cycles). The TYPE 483-C Output Meter, preceded by the TYPE 814-A Amplifier and a TYPE 830 Filter Section, may also be used as a null detector.

### SPECIFICATIONS

**Frequency Range:** 20-20,000 cycles in three ranges by means of a selector switch, 20-200 cycles, 200-2000 cycles, 2000-20,000 cycles.

**Calibration:** Each instrument is individually calibrated in terms of a primary standard of frequency.

**Accuracy:** The null point is narrow enough so that, with sufficient supply voltage or sufficient amplification on the null detector and with a fairly pure waveform, the dial may be set to 0.1%. The calibration on the dial may be relied upon to within 0.5% at all positions.

**Drive:** The 6-inch dial turns through an angle of 320° which gives a scale length of about 17 inches for each 10 to 1 frequency range. The whole scale length is over 4 feet. The dial has a slow-motion drive.

**Impedances:** Input, 3-10 kilohms; output, 1-4 kilohms, the smaller values corresponding to the higher frequencies.

**Input Voltage:** 110 volts, maximum.

**Accessories:** A null detector will be required to operate the instrument. This may be head telephones such as the Western Electric TYPE 1002-C or an amplifier-meter combination such as a TYPE 814-A Amplifier and a TYPE 483 Output Meter or a TYPE 726-A Thermionic Voltmeter, used in conjunction with TYPE 830 Filter Sections. Even with head telephones an amplifier and filter sections may prove useful.

**Controls:** Frequency dial, range selector switch, resistance balance knob.

**Mounting:** Aluminum panel, 1/4 inch thick, finished in black crackle lacquer, mounted in copper-lined walnut cabinet.

**Dimensions:** (Length) 12 x (width) 8 3/4 x (height) 8 1/4 inches, over-all.

**Net Weight:** 15 1/4 pounds.

Type	Frequency Range	Code Word	Price
434-B	20-20,000 cycles	COLOR	\$140.00

PATENT NOTICE. See Notes 17, 18, page v.



## TYPE 834-A ELECTRONIC FREQUENCY METER (A-C OPERATED)

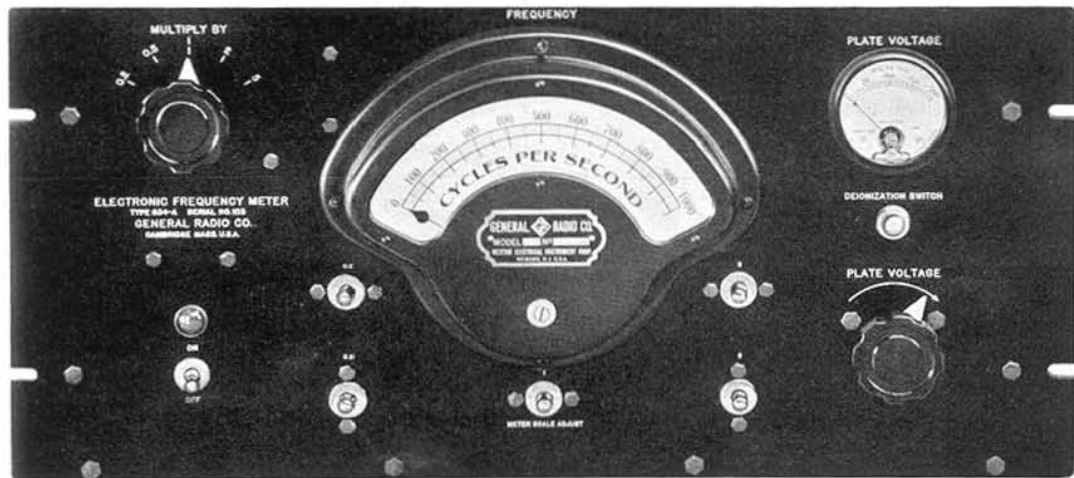

The TYPE 834-A Electronic Frequency Meter fills the need for a general-purpose audio-frequency meter with a pointer-type, direct-reading indication. The frequency is indicated on a large panel-type meter. Five full-scale ranges are provided, covering a range of from 0 to 5000 cycles. The range selection is made by means of a switch. The accuracy of indication is two per cent of full scale or better.

The electronic frequency meter is extremely useful in a frequency measuring system for rapidly determining beat frequencies; in many types of audio-frequency measurement its immediate, direct indication is advantageous; in the educational field it can be used in classroom demonstrations of audio-frequency phenomena. Its industrial applications are numerous, among them the tuning of automobile horns.

The instrument consists essentially of an electronic counter and an indicator. When an alternating voltage is applied to the grids of the gas-discharge tubes, each tube becomes alternately conducting and non-conducting. At each transition of the current from one tube to the other, a current pulse is sent through the indicator circuit. The meter reading depends upon the number of pulses per second, i.e., upon the frequency.

The TYPE 834-A Electronic Frequency Meter is designed for a-c operation and relay-rack mounting.

### SPECIFICATIONS

**Frequency Range:** 0-5000 cycles in five ranges. Full-scale values are 200, 500, 1000, 2000, and 5000 cycles.

**Accuracy:** 2% of full-scale reading or better.

**Stability:** With the exception of a drift of about 1% of full-scale reading in the first few minutes after starting, there is no material change in indication with time.

**Input Impedance:** 1 megohm, approximately.

**Input Voltage:** 2 volts, minimum; the input voltage may be increased to 200 volts with no change in the frequency indication.

**Scale Adjustment:** Independent adjustment is provided on each range. This adjustment is made at the factory, but may be changed if correction is required in the field.

**Power Supply:** 115 volts, 50-60 cycles.

**Power Input:** 45 watts.

**Controls:** Power supply ON-OFF switch; plate voltage adjustment; deionization switch; multiplier (range selector) switch.

**Meters:** Plate voltage; frequency.

# FREQUENCY AND TIME

**Tubes:** Supplied with instrument.

- 1—76 amplifier
- 2—885 gas-discharge tubes
- 1—874 regulator
- 1—82 rectifier
- 1—84 diode switching

**Mounting:** Standard 19-inch relay-rack mounting.  
Unit fitted with dust cover.

**Accessories Supplied with Instrument:** Vacuum tubes, fuses, and pilot lamps (with spares), 115-volt cord-and-plug assembly, multipoint connector.

**Additional Accessories Required:** None.

**Dimensions:** Panel, (width) 19 x (height)  $8\frac{3}{4}$  x (depth) 12 inches.

**Net Weight:** 37 pounds.

Type	Code Word	Price
834-A	MUCUS	\$250.00

PATENT NOTICE. See Notes 1, 24, page v.

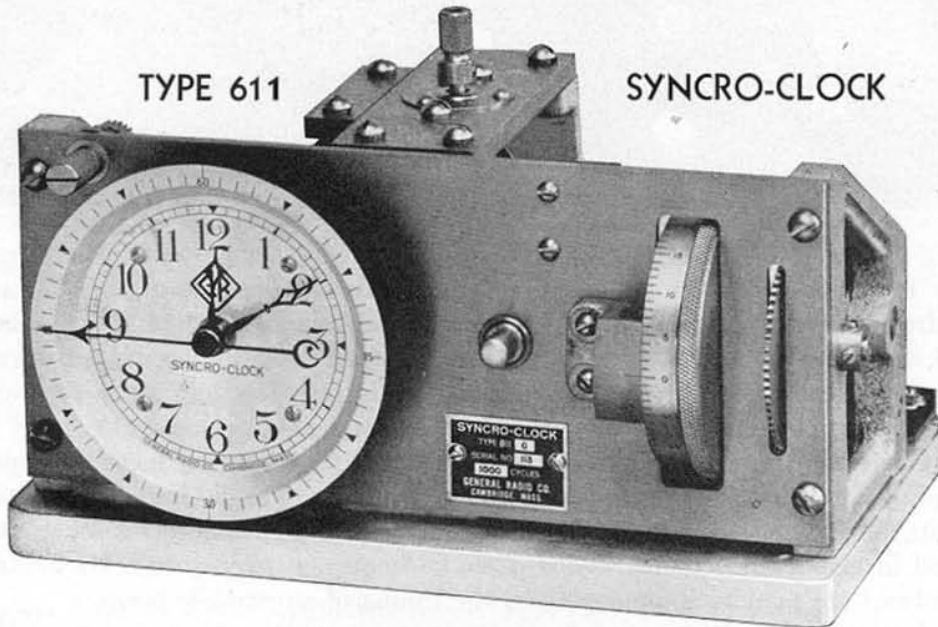

When driven by a stable oscillator, this device may be used as a source of precisely determined time intervals and, conversely, when its indication is compared with standard time, a measure of the driving frequency is obtained.

The TYPE 611 Syncro-Clock is designed to operate from the output circuit of a low-power vacuum tube. The motor is of the impulse type and is brought up to synchronous speed by means of a 60-cycle, 115-volt motor. Clocks are normally supplied to keep true time on an exactly 1000-cycle source. The micro-dial attachment consists of a rotary contact closing once a second, the instant of contact (or phase) being adjustable over a range of one second.

## SPECIFICATIONS

**Frequency:** Clocks are normally supplied to keep true time when the frequency is exactly 1000 cycles.

**Power Consumption:** One 41-type or 45-type tube supplies sufficient power.

**Mounting:** Cabinet-mounted models (for use on the laboratory bench) and panel-mounting models are

available, but only the panel-mounting type with a micro-dial is regularly carried in stock.

**Dimensions:** TYPE 611-C, (width)  $9\frac{3}{8}$  x (depth) 6 x (height) 6 inches.

**Net Weight:** TYPE 611-C, 14 pounds.

Type	Description	Code Word	Price
611-C	Panel Mounting with Micro-Dial.....	SYNCRGOOD	\$220.00

TYPE 724-A

PRECISION WAVEMETER



The TYPE 724-A Wavemeter is a new instrument replacing the older TYPE 224. As a result of the redesign of coils, condenser, and resonance indicator, the new wavemeter has a wider frequency range and a greater sensitivity than its predecessor. The condenser is similar in constructional details to the TYPE 722 Precision Condenser described on page 30.

The condenser setting is indicated on the dial and drum and is controlled from the front of the panel. There are 7500 divisions for the entire 270-degree angular rotation of the condenser rotor. The precision of setting is better than one part in 25,000. The plates are shaped to give an approximately linear variation in frequency with scale setting, making it possible to use calibration charts in tabular form and to interpolate between points in the table.

Seven coils are used to cover a frequency range between 16 kilocycles and 50 megacycles. The coils are enclosed in moulded bakelite cases and are wound on isolantite forms to give low losses and a high degree of stability. The plug-in mounting allows the coil to be rotated to obtain different degrees of coupling.

The resonance indicator is a rectifier-type vacuum-tube voltmeter, a distinct advantage over the thermocouple formerly used, since the danger of overloads burning out the indicator is eliminated.

SPECIFICATIONS

**Frequency Range:** 16 kilocycles to 50 megacycles.  
**Accuracy:** 0.25% between 50 kc and 50 Mc; 1.0% between 16 kc and 50 kc.  
**Calibration:** The calibration is supplied in the form of a table of calibrated points. Linear interpolation between these points is used to obtain settings for other frequencies.  
**Condensers:** Precision worm-drive type similar to TYPE 722. Plates are shaped to give a straight-line-frequency characteristic. The effective angle of rotation is approximately 270°.  
**Inductors:** Coils are wound on isolantite forms and

enclosed in moulded bakelite cases.  
**Resonance Indicator:** A vacuum-tube voltmeter is used to indicate resonance. This is coupled to the tuned circuit through a capacitive voltage divider.  
**Mounting:** A wooden storage case, fitted with lock and carrying handle, is furnished. This has compartments for holding the condenser, inductors, and calibration charts.  
**Dimensions:** Carrying case, 17 $\frac{7}{8}$  x 13 x 12 $\frac{1}{2}$  inches, over-all.  
**Net Weight:** With carrying case, 35 $\frac{1}{4}$  pounds; without carrying case, 18 $\frac{3}{4}$  pounds.

Type	Frequency Range	Code Word	Price
724-A	16 kc to 50 Mc	WOMAN	\$190.00

TYPE 574 WAVEMETER

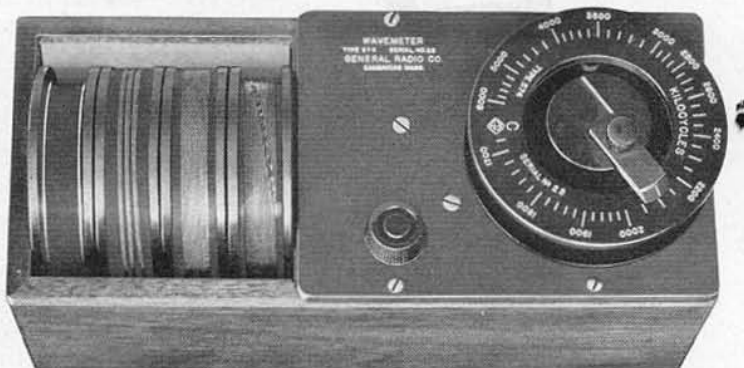

This direct-reading, tuned-circuit wavemeter is well adapted for general purpose work in commercial, experimental, and educational laboratories. It is unusually compact, and its wide frequency range and direct-reading feature make it useful for determining quickly the frequencies of transmitters, receivers, and oscillators.

Its precision is adequate for most routine frequency measurements. Even in high-precision work the time-wasting and bothersome process of locating an unknown frequency on a precision wavemeter can often be simplified by first determining the approximate frequency with the TYPE 574 Wavemeter.

The reaction method of indication should be used with this wavemeter, since no resonance indicator is provided.

SPECIFICATIONS

**Frequency Range:** 166 kc to 70,000 kc (1800 meters to 4.3 meters), by using the five plug-in inductors supplied with the instrument.

**Accuracy:** The construction and calibration of this wavemeter are such that, if carefully made, measurements can be relied upon to within 3% of the indicated frequency.

**Calibration:** Each inductor is individually calibrated at five points in terms of the General Radio Company's primary standard of frequency, and intermediate points are secured by interpolation. The scales themselves are engraved on the inductors, thus making the instrument direct reading. Coil A

and Coil B are engraved in units of megacycles per second, others in kilocycles per second.

**Condenser:** A special TYPE 334 Variable Air Condenser modified by a reduction gear is used to spread the calibration scale over approximately 345°. This facilitates precise settings. The condenser is driven by a slow-motion knob geared to the condenser shaft.

**Mounting:** The condenser is mounted on a bakelite panel attached to the polished walnut case, at one end of which is the storage compartment for spare inductors which are held in place by a spring clamp.

**Dimensions:** (Length) 11 x (width) 5 x (height) 5½ inches, over-all.

**Net Weight:** 4⅝ pounds.

Type	Frequency Range	Equivalent Wavelength Range	Code Word	Price
574	166-70,000 kc	1800-4.3 meters	CARRY	\$50.00



TYPE 419-A RECTIFIER-TYPE WAVEMETER

The TYPE 419-A Rectifier-Type Wave-meter is a tuned-circuit instrument for general use in experimental work in the short-wave band between 1 and 15 meters. Provision is made for indicating resonance by means of a self-contained vacuum-tube rectifier which may be used in conjunction with either its micro-ammeter or a pair of telephone receivers. Any one of the numerous reaction methods may be used.

SPECIFICATIONS

**Frequency Range:** 300 Mc to 20 Mc or 1 meter to 15 meters by using the four plug-in inductors supplied with the instrument.

**Calibration:** Each inductor is individually calibrated with the greatest possible accuracy at several points in terms of the General Radio Company's primary standard of frequency. Each one is supplied with an individually mounted calibration curve which relates condenser scale divisions and frequency in megacycles per second.



**Accuracy:** The construction and calibration of this wavemeter are such that measurements, if carefully made, can be relied upon to within 1% of the indicated frequency.

**Tube:** The necessary tube is supplied.

**Power Supply:** Filament current for the tube is taken from a 1.5-volt, No. 6 dry cell, mounting space for which is contained in the bottom of the cabinet. It is not supplied with the instrument.

**Mounting:** All equipment is carried on an aluminum panel finished in black crackle lacquer, which in turn is mounted on a polished walnut cabinet. The bottom holds the four inductors and their charts.

**Dimensions:** Panel, (height) 10 $\frac{1}{4}$  x (width) 7 $\frac{5}{16}$  inches. Case, (height) 7 $\frac{1}{4}$  inches, over-all.

**Net Weight:** 7 $\frac{3}{4}$  pounds with tube but without battery.

Type	Frequency Range	Equivalent Wavelength Range	Code Word	Price
419-A	300-20 Mc	1-15 meters	CATER	\$100.00

## TYPE 358 WAVEMETER

TYPE 358 Wavemeter is a compact, low-priced instrument of moderate accuracy. It covers a wide frequency range and it is particularly well adapted to general purpose frequency checking in the laboratory.

The normal wavelength range of 15 to 220 meters (20,000 to 1364 kc) can be extended to 950 meters (315 kc) by ordering the two additional coils mentioned in the price list.

### SPECIFICATIONS

**Range:** 15 to 220 meters (20,000 kc to 1364 kc). By ordering the two extra inductors\* mentioned in the price list, the range can be extended to 950 meters (315 kc).

**Accuracy of Calibration:** 1%. Calibrated in wavelength.

**Condenser:** TYPE 247 Condenser with slow-motion pinion-gear drive in drawn-steel case.

**Inductors:** Four, on bakelite forms, fitted with pins to fit condenser terminals.

**Resonance Indicator:** Small flashlight bulb in special socket which closes circuit on removal of bulb.

**Carrying Case:** Space provided in wooden case for four inductors, condenser, and calibration chart.

**Dimensions:** Carrying case, (length) 11 $\frac{3}{4}$  x (width) 7 x (height) 5 $\frac{3}{4}$  inches, over-all.

**Net Weight:** 4 $\frac{1}{2}$  pounds.

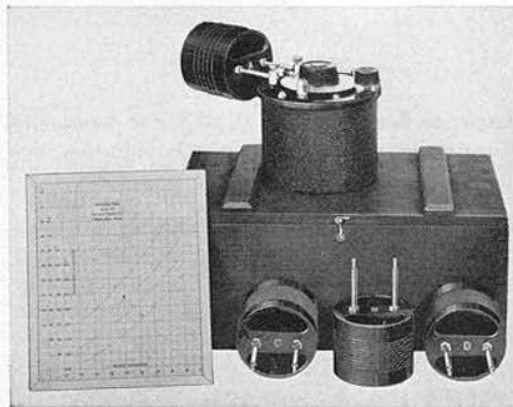

Type	Frequency Range	Code Word	Price
358	15 m to 220 m	UPPER	\$17.50
Additional inductors for extending range to 950 m		*COILY	12.00

\*Use compound code word UPPERCOILY when wavemeter with extra inductors is wanted.

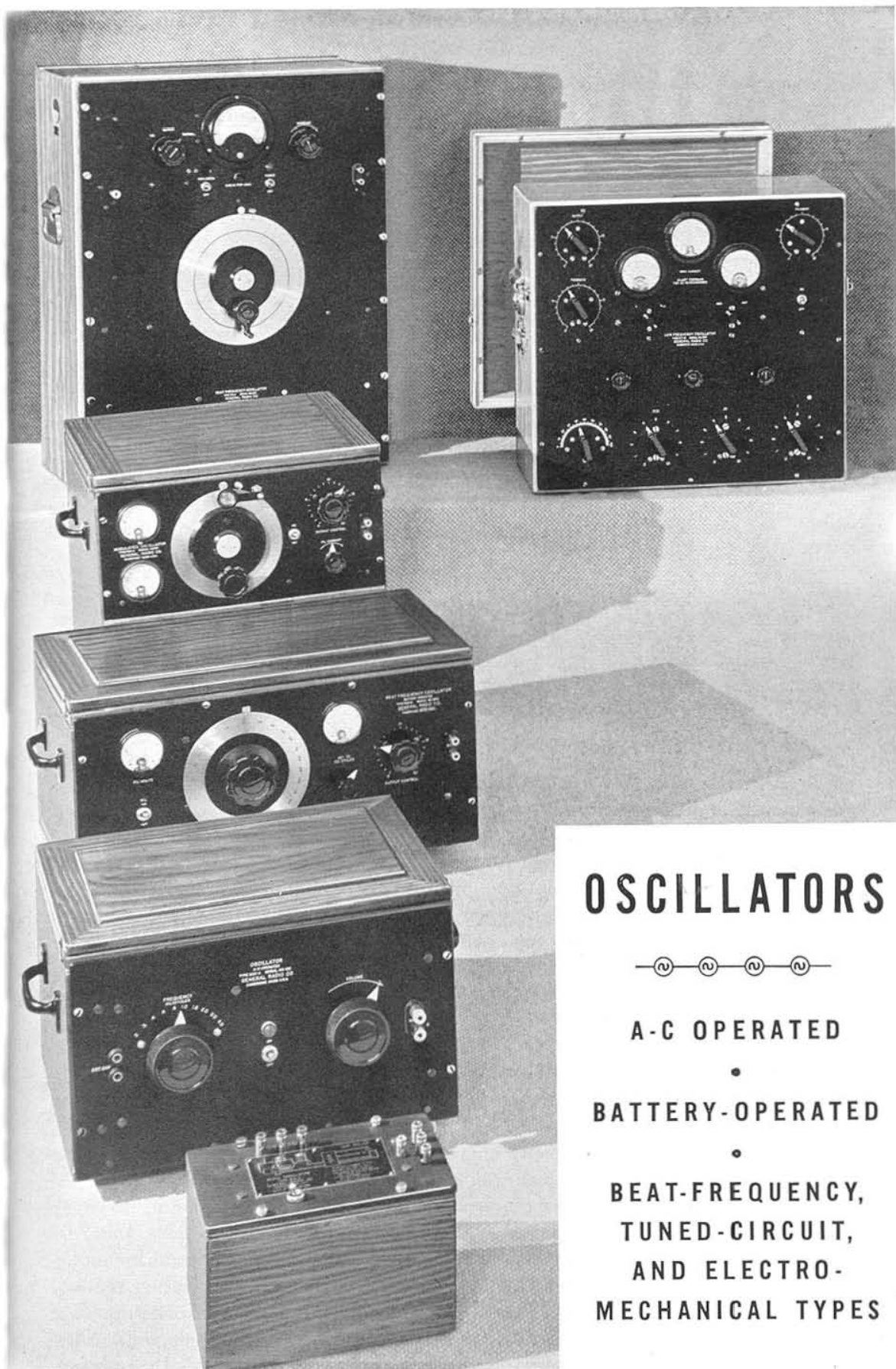

## OSCILLATORS



A-C OPERATED

•

BATTERY-OPERATED

•

BEAT-FREQUENCY,  
TUNED-CIRCUIT,  
AND ELECTRO-  
MECHANICAL TYPES

## TYPE 713-A BEAT-FREQUENCY OSCILLATOR

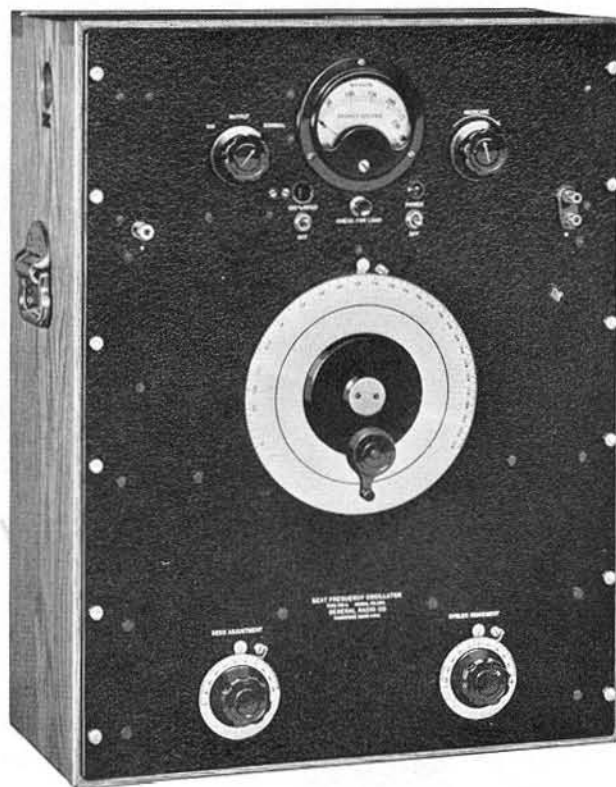

The usefulness of audio-frequency oscillators previously commercially available has been seriously limited by low power output which has necessitated the use of amplifiers.

In the TYPE 713-A Beat-Frequency Oscillator the power output has been increased to two watts, a gain of twenty times over the highest power output previously available in a continuously adjustable audio-frequency oscillator manufactured by this Company. This output, with 130 volts on open circuit, is sufficient for testing many types of equipment and for modulating present types of standard-signal generators without additional amplification. This large increase in output power accompanies a marked improvement in waveform over the TYPE 513-B Beat-Frequency Oscillator which this instrument replaces.

In general design the TYPE 713-A Beat-Frequency Oscillator is an alternating-current-operated oscillator operating on the beat principle in which the output results from the beat between two high-frequency oscillators, one of which is fixed, the other continuously adjustable. A frequency range of 10 to 20,000 cycles is covered. The dial carries an accurate, individually engraved calibration. The calibration may be checked by means of a self-contained, calibrated tuned reed.

The distinguishing characteristic of a beat-frequency oscillator is its ability to cover continuously a wide frequency range with one control and, at the same time, to maintain approximately constant output. By means of such a circuit, the entire audio-frequency range may be covered by the rotation of a single dial. This feature renders the beat-frequency type of oscillator useful for the rapid study of all types of equipment.

The main dial is supplemented by an incremental condenser, calibrated over a range of  $-50$  to  $+50$  cycles, which facilitates accurate setting of frequency. It is also of



value in obtaining small pitch variations, as are frequently required in physiological and psychological studies.

The design of the instrument is such that the waveform and power output are ample for practically all experimental uses. When it is used in accordance with the operating instructions, the reliability of the frequency calibration is excellent. Both oscillators operate near 180 kilocycles, and the circuits are adjusted so that the difference frequency may be reduced to 1 cycle without their "pulling into step" with each other.

## SPECIFICATIONS

**Frequency Range:** Although calibrated between 10 cycles and 20,000 cycles only, it will deliver power over a slightly wider range.

**Frequency Control:** The main control dial is engraved at least at every one-hundred-cycle interval, the total scale length being approximately 18 inches. There is an additional auxiliary control covering a band 50 cycles wide on either side of the frequency determined by the setting of the main dial. This is useful for making resonance curves, measuring pitch increments, and the like.

**Frequency Calibration:** A tuned 100-cycle reed is provided to supply a checking point. In operation, the main tuning control is set to 100 cycles, and a zero-adjusting condenser is adjusted until the oscillator frequency and the reed frequency are in agreement, as shown by maximum deflection of the reed. The reed adjustment is correct to within 1 cycle.

Each instrument is individually calibrated, and the main tuning-control dial is then engraved.

The auxiliary dial is marked with one division for every 1-cycle interval.

The calibration can be relied upon to within 2% after the oscillator has been adjusted to the reed frequency at the 100-cycle point, within one year from the date of purchase.

**Frequency Stability:** Great care in design has been taken to provide adequate thermal insulation and ventilation, thereby practically eliminating frequency drifts from this cause.

The frequency may drift 5 to 10 cycles in the first two hours from heating, but it is negligible thereafter in the absence of a marked change in room temperature. A 15-volt change in supply voltage causes less than 1 cycle shift in output frequency. If the accuracy of the work justifies such a precaution, the oscillator may at any time be checked against the tuned reed.

**Output:** Maximum open-circuit voltage is at least 130 volts; maximum power output is about 2 watts into a load of 2000 ohms. The output control is a

30,000-ohm tapered voltage divider. Output voltage is measured by a linear-scale vacuum-tube voltmeter.

For any resistive load the output voltage varies by less than 0.5 db (5%) between 30 and 10,000 cycles; less than 1.4 db (15%) between 10 and 16,000 cycles.

**Waveform:** With a 5000-ohm load at frequencies above 100 cycles, total harmonic content is less than 1% of the fundamental amplitude. At 10 cycles, harmonics are less than 5% (introduced by the iron-core output transformer).

By throwing a switch on the panel, the output voltage is reduced to 1/10 of its normal value, and the harmonic content is brought down to less than 1% over the entire range of the instrument. Power-supply ripple is approximately 0.1% on full output; 1% when the output voltage has been reduced by 10:1.

A means of checking the performance of the oscillator is provided so that improper load conditions, which would increase the harmonic content, can be detected.

**Power Supply:** 100-120 volts, 40-60 cycles, ac. The power consumption is about 85 watts.

**Mounting:** This instrument is available in either cabinet or relay-rack mounting. The cabinet is a heavy oak case fitted with carrying handles. For relay-rack mounting, the cabinet is replaced with a metal dust cover and shield.

**Tubes:** The necessary tubes, 3 type 41, 3 type 6C6, 2 type 2A3, and 1 type 80, are supplied.

**Accessories:** 7-foot connecting cord is supplied.

**Dimensions:** Panel, (width) 19 x (height) 24 $\frac{1}{4}$  inches. Over-all cabinet size, including handles, (width) 20 $\frac{1}{2}$  x (height) 25 x (depth) 11 inches.

Screw holes in the panel are the standard spacing for mounting the instrument in a TYPE 480 (standard 19-inch) Relay Rack.

**Net Weight:** 87 pounds.

<i>Type</i>	<i>Description</i>	<i>Code Word</i>	<i>Price</i>
713-AM	Cabinet Model.....	DEBAR	\$485.00
713-AR	Relay-Rack Model.....	DETER	510.00

PATENT NOTICE. See Notes 1, 3, 10, page v.

## TYPE 613-B BEAT-FREQUENCY OSCILLATOR



This is a battery-operated instrument which possesses the desirable features of good waveform, frequency stability, and open scale which characterize the TYPE 713-A Beat-Frequency Oscillator previously described.

This oscillator is adjusted to the calibrated conditions by setting to resonance with a one-hundred-cycle tuned reed. The dial of each instrument is individually calibrated and engraved.

The TYPE 613-B Oscillator has been found especially valuable in physiological and psychological research at audio frequencies. A useful accessory to the oscillator in this application is the TYPE 539-P Incremental-Pitch Condenser (see next page). This condenser is calibrated in single-cycle frequency increments and can be used to vary the output frequency repeatedly over any range of less than 100 cycles above the main dial setting.

The output has been carefully filtered to eliminate spurious high frequencies.

### SPECIFICATIONS

**Frequency Range:** Calibrated between 10 cycles and 11,500 cycles, it will actually deliver power at frequencies slightly lower and higher, respectively, than these.

**Frequency Calibration:** A reference calibration is secured by setting the main tuning control to the 100-cycle graduation, marked "REED," and then adjusting the compensating condenser until the calibrated tuned reed vibrates at maximum amplitude.

Each instrument is individually adjusted in terms of a primary standard of frequency to agree with the etched dial, and the dial of the main tuning control is then engraved. The dial is 6 inches in diameter and has a spread of  $270^\circ$  so that the scale is spread out over almost 14 inches.

For one year from the date of purchase, the calibration can be relied upon to within 2% after the oscillator has been checked against the 100-cycle reed.

**Frequency Stability:** The high-frequency oscillators are stable, and under uniform temperature conditions the beat frequency will stay within a few cycles over a period of several hours. Changes in ambient temperature will cause slight changes in frequency because of the temperature coefficient of the tuned circuits. When a drift in frequency is observed, it can be corrected by readjusting for maximum amplitude of the tuned reed.

**Output:** The open-circuit output voltage does not depart by more than 20% from an average value of approximately 16 volts over the entire frequency range. The maximum power output varies slightly with different instruments, but is approximately 15 milliwatts.

**Internal Output Impedance:** 5000 ohms.

**Waveform:** On open circuit the total harmonic content is less than 2% of the fundamental above 100 cycles. With a 5000-ohm load it is less than 5% above 100 cycles; below 100 cycles it increases rapidly as the frequency is reduced.

**Controls:** In addition to the main tuning control and the auxiliary control for adjusting to the 100-

cycle reference frequency, there are the output voltage divider and the filament and tuned-reed ON-OFF switches.

**Meters:** A filament voltmeter and a detector plate-current meter are mounted on the panel.

**Tubes:** Three 30-type and one 31-type (RCA or equivalent) tubes are required and are supplied as initial equipment.

**Terminals:** Two binding posts on the panel are provided for making connections to the oscillator.

**Power Supply:** Space for mounting three 45-volt plate batteries and two No. 6 dry cells for filament supply is provided inside the cabinet.

**Mounting:** The instrument is mounted on an aluminum panel finished in black crackle lacquer and contained in a polished walnut cabinet with carrying handles.

**Dimensions:** Panel, (width) 19 x (height) 8 $\frac{3}{4}$  inches. Cabinet, (width) 22 x (height) 12 $\frac{1}{4}$  x (depth) 9 inches, over-all.

**Net Weight:** 33 $\frac{1}{4}$  pounds without batteries.

<i>Type</i>	<i>Code Word</i>	<i>Price</i>
613-B	NAVAL	\$210.00

PATENT NOTICE. See Notes 1, 3, 10, 17, page v.

## TYPE 539-P INCREMENTAL-PITCH CONDENSER

The incremental-pitch condenser is designed for use with TYPE 613-B Beat-Frequency Oscillator. It is calibrated in divisions of one cycle over a 100-cycle range. When the condenser is calibrated in conjunction with the oscillator with which it is to be used, the frequency can be changed by any desired number of cycles (less than 100) at any point on the oscillator dial.

When the TYPE 539-P Incremental-Pitch Condenser is ordered with a TYPE 613-B Beat-Frequency Oscillator, the necessary modifications in the oscillator are made before shipment.

A "Returned Apparatus Tag" that may be secured on application must accompany the oscillator when it is returned for the addition of a TYPE 539-P Incremental-Pitch Condenser.

### SPECIFICATIONS

**Condenser:** Identical in construction with TYPE 539 Condensers described on page 33. **Calibration:** 0 to 100 cycles, frequency increase.

<i>Type</i>	<i>Description</i>	<i>Code Word</i>	<i>Price</i>
539-P	Incremental-Pitch Condenser . . . . .	AUDIT	\$50.00*

\*Price includes necessary modifications to TYPE 613-B Beat-Frequency Oscillator, calibration, and also a shielded connecting cable.

## TYPE 377-B LOW-FREQUENCY OSCILLATOR



A TUNED-CIRCUIT OSCILLATOR  
COVERING A  
WIDE FREQUENCY RANGE

For certain classes of work, the tuned-circuit vacuum-tube oscillator is still preferred to the beat-frequency type. It covers, in general, a wider frequency range and has a greater percentage frequency stability at the lower frequencies. It suffers from the disadvantage of not being as easily set to a desired frequency.

TYPE 377-B Low-Frequency Oscillator is a tuned-circuit instrument covering frequencies between 25 cycles and 70,000 cycles. It can also be furnished to operate at 10 cycles.

### SPECIFICATIONS

**Frequency Range:** Any frequency between 25 cycles and 70,000 cycles can be obtained. The range can be extended downward to 10 cycles for a small additional charge.

**Power Output:** At 10 kc and below, 50 milliwatts with one amplifier tube; 100 milliwatts with two amplifier tubes. Above 10 kc, the output is substantially lower. It is adjustable by means of a voltage divider. The internal output impedance with the voltage divider set for maximum output is approximately 2000 ohms with two amplifier tubes and 3500 ohms with one amplifier tube.

**Waveform:** The maximum harmonic content is about 3% of fundamental amplitude. Most of it is introduced by the amplifier.

This may be reduced to about 1% for loads of 8000 ohms or more by reducing the signal level applied to the amplifier. The method of doing this involves changing coupling resistors and is described in the instructions accompanying the instrument.

**Calibration:** A frequency calibration for 50 points, accurate to within 1%, is supplied with each instrument. The corresponding settings of the condensers and the inductor switches are entered on

two charts. One is mounted inside the back cover, the other in an aluminum chart holder.

**Frequency Stability:** Changes in tubes and operating voltages have a minor effect on the frequency.

**Mounting:** All parts are mounted on an engraved bakelite panel in a heavy oak case with carrying handles and a cover. The case may be bolted to the wall, hinges allowing the cabinet to swing out for replacing tubes, etc.

**Terminals:** All battery and output terminals are inside the case, which has holes in its side for the connecting wires.

**Tubes:** Two or three 112-A-type (RCA or equivalent) tubes are used, one as an oscillator and either one or two as amplifiers. Tubes are supplied with the instrument as initial equipment.

**Power Supply:** 135 volts, 16 ma (plate) and 6 volts, 0.75 a (filament) are required to operate three tubes in addition to the grid-biasing battery mounted inside the case. Only the latter is included in the price of the instrument.

**Dimensions:** Cabinet with cover, (width)  $19\frac{1}{8}$  x (height) 18 x (depth)  $10\frac{1}{2}$  inches, over-all.

**Net Weight:** 55 pounds.

Type	Code Word	Price
*377-B	OMEGA	\$350.00
Alteration to extend range downward to 10 cycles	EXTRA	35.00

\*Use the compound code word OMEGAEXTRA when ordering an oscillator with the alteration.  
PATENT NOTICE. See Notes 1, 3, page v.



TYPE 508-A OSCILLATOR

A POWER SOURCE FOR  
AUDIO-FREQUENCY BRIDGE  
MEASUREMENTS



This is an a-c operated oscillator of medium power, yielding ten frequencies separated by approximately equal percentage intervals to cover the more commonly used portion of the audio range. It is intended primarily for use in bridge measurements.

The output power is 0.5 watt and both frequency stability and waveform are good for an oscillator delivering this power output. There is no direct current in the output circuit.

Both relay-rack and cabinet models are available.

SPECIFICATIONS

**Frequency Range:** The 10 frequencies available are 200, 300, 400, 600, 800, 1000, 1600, 2000, 3000, and 4000 cycles. Selection is made by a single 10-point switch. Frequencies between these values can be secured by the use of an external condenser which can be plugged into the jack terminals on the panel at the left. For frequencies between 250 cycles and 4000 cycles a TYPE 219-G Decade Condenser with a TYPE 335-Z Variable Air Condenser is suitable. Between 200 cycles and 250 cycles an additional 0.5- $\mu$ f condenser is required. These condensers are not supplied with the instrument.

**Frequency Stability:** Any frequency of this oscillator can be relied upon to remain constant to within 1% over a period of several hours in spite of changes in load or line voltage.

**Waveform:** On open circuit, the total harmonic content of the output wave is less than 8% of the fundamental amplitude. This increases as the load impedance is reduced, approaching a maximum of 11% when the output terminals are short-circuited. The maximum open-circuit hum voltage across the terminals is 0.5 volt.

**Frequency Calibration:** Each instrument is adjusted

in our laboratory to within 5% of the frequencies engraved on the panel.

**Output:** Approximately 0.5 watt into a load of 2000 ohms. This maximum power output varies between approximately 0.3 watt and 0.8 watt as the frequency is changed. A high-impedance voltage divider for adjusting the power output is included.

**Internal Output Impedance:** 2000 ohms at maximum output.

**Vacuum Tubes:** One 45-type tube and one 80-type rectifier tube (RCA or equivalent) are supplied.

**Mounting:** The oscillator is shielded and can be supplied either in a walnut cabinet or with panel extensions for mounting on a 19-inch relay rack.

**Dimensions:** For TYPE 508-AM: Panel, (width) 15 x (height) 8 $\frac{3}{4}$  inches. Cabinet, (width) 18 x (height) 10 x (depth) 12 $\frac{1}{2}$  inches, over-all.

For TYPE 508-AR: (Width) 19 x (height) 8 $\frac{3}{4}$  x (depth behind panel) 10 inches, over-all.

**Power Supply:** 100 to 120-volt, 50 to 60-cycle line. The power drain is about 40 watts.

**Net Weight:** 38 pounds for TYPE 508-AM and 30 $\frac{1}{4}$  pounds for TYPE 508-AR.

Type	Description	Code Word	Price
508-AM	Cabinet Mounting . . . . .	ARROW	\$120.00
508-AR	For Relay-Rack Mounting . . . . .	ARSON	120.00

PATENT NOTICE. See Note 1, page v.

## TYPE 813 AUDIO OSCILLATOR

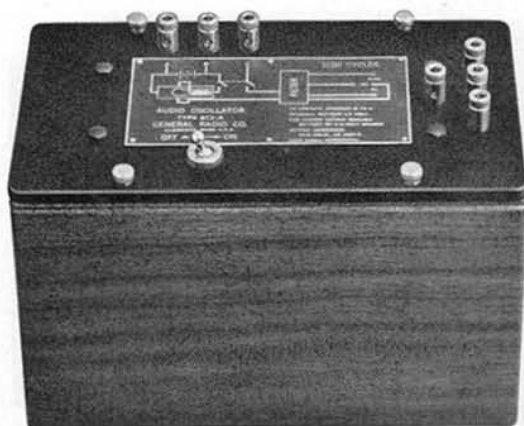

This instrument is a battery-operated electro-mechanical oscillator in which the frequency is determined by a tuning fork. Mechanically, the oscillator is simple and of rugged construction. Electrically, it has excellent waveform and frequency stability.

The driving and output circuits are independent and use separate microphone buttons, so located and mounted that the tines are equally loaded and the free vibration of the fork is only slightly influenced by their presence.

The fork is mounted rigidly at the heel above a small metallic base panel which carries the driving electromagnet located between the tines. The base panel is suspended internally with four resilient mountings beneath a bakelite panel, which carries the terminal posts and control switch and which serves as a cover for the walnut cabinet.

A filter is provided to eliminate harmonics from the output.

### SPECIFICATIONS

**Frequency:** Two models are available, one operating at 1000 cycles and one at 300 cycles, but special instruments can be constructed for any 100-cycle multiple between 300 cycles and 1500 cycles. Designs are on file; prices on request.

**Frequency Stability:** The temperature coefficient of frequency is  $-0.007\%$  per degree F. The voltage coefficient is less than  $0.01\%$  per volt. The frequency is entirely independent of load impedance.

**Accuracy:** The frequency is adjusted within  $0.05\%$  of its specified value. The actual frequency is measured and recorded on the base of the cabinet to an accuracy of  $0.2\%$ .

**Output:** The output to a matched load impedance is 20 to 30 milliwatts with 6-volt drive and 10 to 15 milliwatts with  $4\frac{1}{2}$ -volt drive.

**Internal Output Impedance:** Three output impedances of 50, 500, and 5000 ohms respectively are provided.

**Waveform:** The total harmonic content is less than  $1.0\%$  with  $4\frac{1}{2}$ -volt drive and less than  $1.5\%$  with 6-volt drive.

**Power Supply:** For intermittent operation with a moderate power output, an internal  $4\frac{1}{2}$ -volt battery can be used. For greater output or continuous operation, an external battery of  $4\frac{1}{2}$  to 6 volts should be used.

**Terminals:** Three binding posts for the power supply and four for the output circuit are provided on the panel.

**Mounting:** The fork is suspended from a metal plate on a bakelite panel and is enclosed in a walnut cabinet.

**Dimensions:** Both models, (length) 9 x (width) 5 x (height) 6 inches, over-all.

**Net Weight:**  $8\frac{1}{4}$  pounds.

Type	Frequency	Code Word	Price
813-A	1000 cycles	ANGEL	\$34.00
813-A	400 cycles	AMUSE	36.00

TYPE 484-A MODULATED OSCILLATOR



This is a portable, general-purpose, radio-frequency oscillator covering the wide range of frequencies so often required for the laboratory. It is modulated and sufficiently well shielded to permit of its use in radio-frequency bridge-circuit measurements where the expense of a perfectly shielded standard-signal generator is neither necessary nor justifiable.

A straight-line-frequency condenser driven by a precision dial is used for tuning. All inductors are plug-in and are stored in the drawer below the panel when not in use. Space is provided inside the cabinet for batteries.

SPECIFICATIONS

**Frequency Range:** 10 kc to 40 Mc by means of ten plug-in inductors. In addition, two band-spread inductors are available. Inductors are not included in the price of the instrument and must be ordered separately. See TYPE 484-P Inductors below.

**Calibration:** Calibrations are not included. On special order, however, a calibration curve accurate to within 1% can be supplied for any inductor. (See price list.) Inductors must be calibrated in the oscillator with which they are to be used.

**Voltage Output:** For frequencies in the broadcast band and below, the maximum output is 2.0 volts. At higher frequencies the voltage progressively decreases until at the highest frequencies it is approximately 0.2 volt. Over the range of one coil the output voltage varies by a ratio of approximately 1.5 to 1.

**Modulation:** Internal 1000-cycle vacuum-tube oscil-

lator, providing approximately 30% modulation.

**Tubes:** Two 30-type tubes, supplied with the instrument.

**Batteries:** Two No. 6 dry cells and three 45-volt Burgess No. 5308 batteries, or equivalent, are necessary. These are not included in the price of the instrument. Space for batteries is provided in the cabinet.

**Mounting:** The oscillator is assembled on a black crackle-finish aluminum panel and mounted in a shielded walnut cabinet. A drawer is provided for the inductors not in use.

**Dimensions:** (Length) 18 x (depth) 14½ x (height) 12¾ inches.

**Net Weight:** 32½ pounds, without batteries; 46½ pounds with batteries.

Type	Code Word	Price
484-A	CREST	\$160.00*

\*Does not include batteries or inductors.  
PATENT NOTICE. See Notes 1, 10, page v.

## TYPE 484-P INDUCTORS

### SPECIFICATIONS

**Dimensions:** TYPE 484-P1 to TYPE 484-P14, (length)  $2\frac{7}{8}$  x (width)  $2\frac{3}{8}$  x (height)  $5\frac{3}{8}$  inches, 3 x (diameter)  $3\frac{3}{4}$  inches, over-all. TYPE 484-P21, including plugs.

<i>Type</i>	<i>Frequency Range</i>	<i>Net Weight</i>	<i>Code Word</i>	<i>Price</i>
*484-P1	25 Mc to 40 Mc	6 ounces	MODOSCBIRD	\$8.00
*484-P2	9.4 Mc to 25 Mc	6 ounces	MODOSCDISK	8.00
*484-P3	3.55 Mc to 9.4 Mc	9 ounces	MODOSCFORD	8.00
*484-P4	1500 kc to 3550 kc	8 ounces	MODOSCGIRL	8.00
*484-P5	500 kc to 1500 kc	10 ounces	MODOSCGOAT	10.00
*484-P8	160 kc to 500 kc	7½ ounces	MODOSARMY	10.00
*484-P9	60 kc to 160 kc	6 ounces	MODOSCALLY	10.00
*484-P10	27 kc to 60 kc	6½ ounces	MODOSCEYRE	10.00
*484-P11	160 kc to 270 kc	9 ounces	MODOSCHYMN	10.00
*484-P12	100 kc ± 2 kc	9 ounces	MODOSMILK	10.00
*484-P13	15 kc to 27 kc	7 ounces	MODOSCITCH	10.00
*484-P14	10 kc to 15 kc	7 ounces	MODOSCONLY	10.00
484-P21	400-Cycle Modulating Unit	3¾ pounds	MODOSCPALM	12.00
	Frequency Calibration (per Inductor)		CURVE	5.00

\*Frequency calibration supplied only when ordered. To order calibrated inductors, use compound code words, e. g., MODOSCBIRD-CURVE, etc.

PATENT NOTICE. See Note 1, page v.



### 1000-CYCLE BRIDGE SOURCE

Vibrating-reed type, carbon-button drive from 4.5 volts. See the description of the TYPE 572-B Microphone Hummer, page 137.



## TYPE 814-A AMPLIFIER



This is a general-purpose laboratory amplifier intended for use where high gain is required over the audio-frequency range. Since the instrument is operated entirely by dry batteries, the output is free from hum. The cabinet is large enough to accommodate all necessary batteries so that the unit is entirely self-contained and readily portable.

An amplifier of this type is extremely valuable for bridge measurements. The high gain increases the sensitivity of a pair of ordinary headphones by nearly 80 db at 1000 cycles. The logarithmic gain control provides a convenient means of adjusting the amplification to a satisfactory value. Provision is made for plugging in anti-resonant tuned circuits across the coupling circuit between the second and third stages of amplification. This gives a simple and effective means for restricting the amplifier response to a narrow range of frequencies, thus eliminating harmonics and noise when balancing a bridge.

In designing this amplifier, it was considered more important to have high gain over the audio-frequency range than to have an absolutely flat characteristic over an extremely wide range. The gain is practically constant between 20 and 10,000 cycles and the amplifier is still usable at frequencies up to 50 kc although the characteristic is not flat.

### SPECIFICATIONS

**Amplification:** The gain of the amplifier throughout the greater portion of the audio-frequency range is approximately 90 db when operating into a high impedance (1 megohm or more) such as a vacuum-tube voltmeter or a cathode-ray oscillograph. When operating into a 20,000-ohm load such as, for instance, a TYPE 483-C Output Meter, the gain is approximately 77 db. About this same amount of

gain is secured at 1000 cycles when operating into an average pair of telephones.

The above figures for gain in the amplifier represent merely voltage ratios and do not take into account the fact that the input impedance of the amplifier is generally considerably higher than the load impedance connected to the amplifier. Naturally, an input transformer greatly increases the

# AMPLIFIERS

sensitivity in cases where the amplifier is operating from a low impedance. Care must be taken, however, to see that the transformer does not introduce undesirable hum pickup, etc.

It is also possible to increase the sensitivity in many cases by using an output transformer for matching the output circuit to the load. Because of the high gain of the amplifier, however, it is seldom necessary to use either input or output transformers in order to obtain satisfactory sensitivity.

**Frequency Range:** From 20 cycles up, the gain of the amplifier is practically constant throughout the audio-frequency range, dropping approximately 4 db at 10,000 cycles. The amplifier has sufficient gain at higher frequencies to be useful for many purposes. For instance, when operating into 1 megohm the maximum gain at 20 kc is slightly over 80 db, and at 50 kc, it is about 65 db.

**Input Impedance:** In order that the amplifier may be used directly from conventional types of piezo-electric microphones or vibration pickups, the resistance leak in the input circuit has been made 5 megohms. The actual input impedance, accordingly, consists of this leak in parallel with a shunting capacitance. This capacitance amounts to approximately 35  $\mu\mu\text{f}$  when the INPUT VOLTAGE is on the LOW position. When this switch is set on the HIGH position, the effective shunting capacitance is reduced to approximately 22  $\mu\mu\text{f}$ . A series capacitance of 0.02  $\mu\text{f}$  is provided in the input circuit so that the application of a direct voltage to the input terminals will not affect the operation of the amplifier.

Much of the input capacitance is caused by the binding posts, the capacitance of the input condenser and switch to ground, etc. For applications where an extremely low input capacitance is desirable, it is possible to connect directly to the grid cap of the input tube, removing the grid clip and thus disconnecting the standard input circuit.

**Output Impedance:** The output impedance of the amplifier is approximately 70,000 ohms. A blocking condenser of 1  $\mu\text{f}$  is included in series with the output terminals so that no direct voltage appears on these terminals.

**Tuning:** A jack marked "F" is provided on the panel and connects directly to the grid of the output tube. An anti-resonant circuit may be connected to a standard telephone plug and inserted in the circuit at this point, thus modifying the gain of the amplifier by the frequency-selective characteristics of the tuned circuit. The actual impedance of the inter-stage coupling circuit is roughly 200,000 ohms, which should be taken into consideration when designing suitable anti-resonant circuits.

**Tubes:** The amplifier requires three 34-type tubes, which are included in the price of the instrument.

**Power Supply:** Batteries are supplied. The following batteries are furnished for the TYPE 814-AM Amplifier: two 1.5-volt No. 6 dry cells or equivalent, three 45-volt batteries (such as Burgess No. 5308, Eveready Type 762) and one large flashlight cell. In cases where light weight is of unusual importance, Burgess No. Z30P 45-volt or other portable type batteries may be used in the cabinet-mounted model in place of the larger batteries listed above.

For use with the relay-rack mounted TYPE 814-AR the following batteries are used: two Burgess No. 4FA (Little 6's) or equivalent, three Burgess No. Z30P 45-volt batteries or equivalent and one Burgess No. 2FBP 1.5-volt battery or equivalent.

**Mounting:** The amplifier is supplied in two types of mounting. The TYPE 814-AM Amplifier is mounted in a walnut cabinet having space for batteries. The TYPE 814-AR Amplifier is provided with a panel extension for relay-rack mounting. This panel extension includes battery space and provision is made for mounting a rectifier-type meter.

**Dimensions:** Panel size, (width) 12 x (height) 7 inches. Cabinet size for TYPE 814-AM, (width) 15 x (height) 8 $\frac{1}{4}$  x (depth) 12 $\frac{1}{4}$  inches, over-all. Size for TYPE 814-AR, (width) 19 x (height) 7 x (depth) 10 inches, over-all.

**Net Weight:** TYPE 814-AM, 17 $\frac{3}{4}$  pounds; necessary batteries, approximately 14 pounds. TYPE 814-AR, 13 pounds; necessary batteries, approximately 7 $\frac{1}{2}$  pounds.

Type	Description	Code Word	Price
814-AM	Cabinet Mounting.....	APPLE	\$97.50*
814-AR	For Relay-Rack Mounting.....	ALONE	97.50*

\*Price includes both tubes and batteries.  
PATENT NOTICE. See Note I, page v.

## TYPE 714-A AMPLIFIER



TYPE 714-A Amplifier is a high-gain, wide-range, a-c operated instrument designed mainly for use with cathode-ray oscillographs. It can also be used as a bridge amplifier and for many other purposes where a high voltage gain is desired. When used with a TYPE 687-B Electron Oscillograph, equivalent deflection sensitivities as great as one hundred inches per volt can be obtained without appreciable distortion.

The maximum gain of 80 db is obtained with an extremely low hum level, equivalent to approximately 10 microvolts on the grid of the first tube. Full output can be obtained with any input voltage between 10 millivolts and 10 volts. Microphonic effects are minimized by the use of indirectly-heated-cathode tubes, and the amplifier is actually quieter than many battery-operated amplifiers of equal gain.

The circuit is of the resistance-capacitance coupled type using three pentode tubes, thus providing high amplification over a wide range of frequencies.

The frequency range of 5 cycles to 50 kc makes the amplifier extremely useful as a general-purpose laboratory instrument, particularly in low-frequency work. The power supply filter has been carefully designed to prevent self-oscillation at low frequencies and to insure stable operation. The same model can be used for either table or relay-rack mounting.

## SPECIFICATIONS

**Gain:** The gain is continuously adjustable between 20 db and 80 db, by means of a gain control and a switch. With the switch set at 50 db, the range of the gain control is from 20 to 50 db; with the switch on 80, the range is from 50 to 80 db.

**Frequency Characteristics:** The gain at 5 cycles and at 50 kc is down 3 db from the flat portion of the characteristic.

**Maximum Input Voltage:** 14 volts, maximum peak; 10 volts rms on a sinusoidal wave.

**Maximum Output Voltage:** 140 volts, maximum peak; 100 volts rms on a sinusoidal wave.

**Load Impedance:** Although the internal output impedance is about 20,000 ohms, the load resistance should not be less than 100,000 ohms for an undistorted output of 100 volts. As a bridge null detector this is not important and maximum power gain will be obtained into a load of about 20,000 ohms. One output terminal is grounded.

**Input Impedance:** The input resistance is over one

# AMPLIFIERS

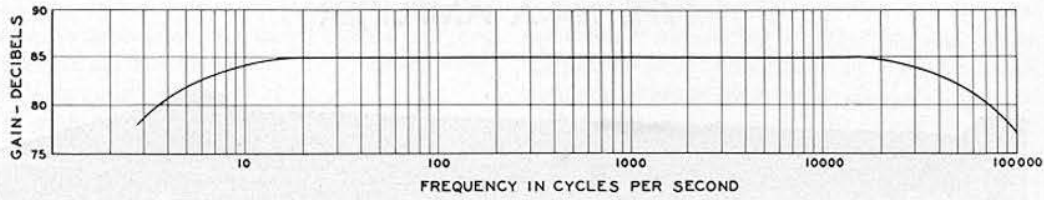

Frequency characteristic of a TYPE 714-A Amplifier

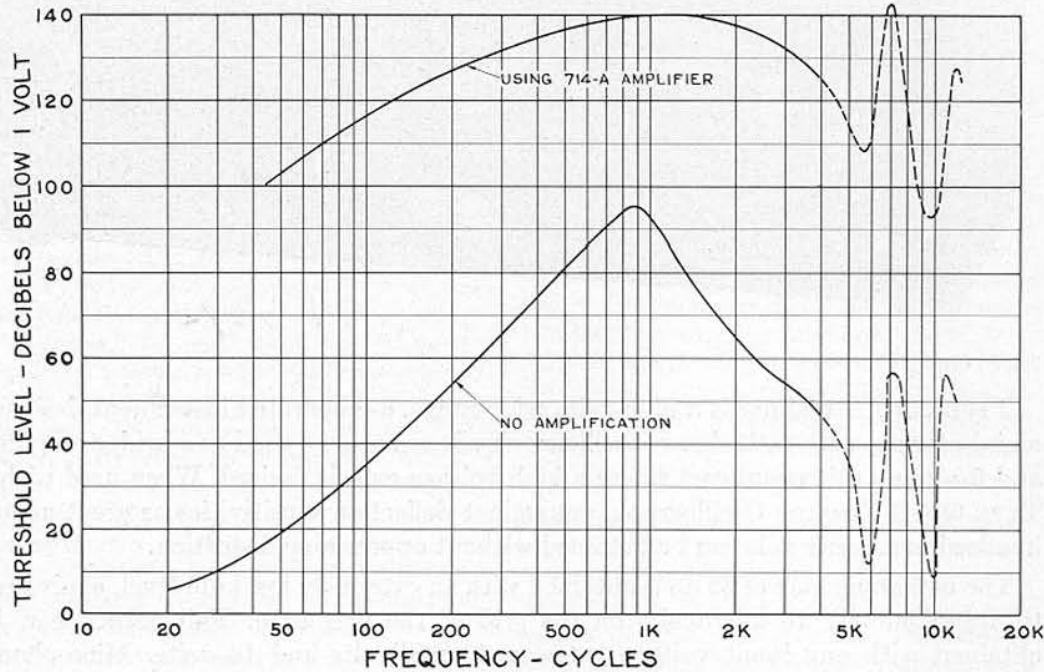

This plot shows both the gain and the improvement in the frequency characteristic which result when the TYPE 714-A Amplifier is used with a pair of head telephones. Since, in balancing bridges, the threshold of hearing determines the sensitivity, this quantity is used as the ordinate of the plot

megohm. The shunt capacitance is about 15  $\mu\mu f$  with the gain switch on 50 and about 40  $\mu\mu f$  with the switch set at 80.

**Power Supply:** 110 to 120 volts, 40 to 60 cycles, a-c mains.

**Power Consumption:** 25 watts.

**Vacuum Tubes:** Two 6C6, one 89 and one 80, all of which are supplied with the instrument.

**Mounting:** Wooden ends are used for table mounting and are removable if the amplifier is to be used on a relay rack.

**Accessories Supplied:** Vacuum tubes, 7-foot power cord, and spare pilot light.

**Dimensions:** (Length) 19 x (depth) 10½ x (height) 7 inches, over-all.

**Net Weight:** 40 pounds.

Type	Code Word	Price
714-A	AURAL	\$190.00

PATENT NOTICE. See Note 1, page v.



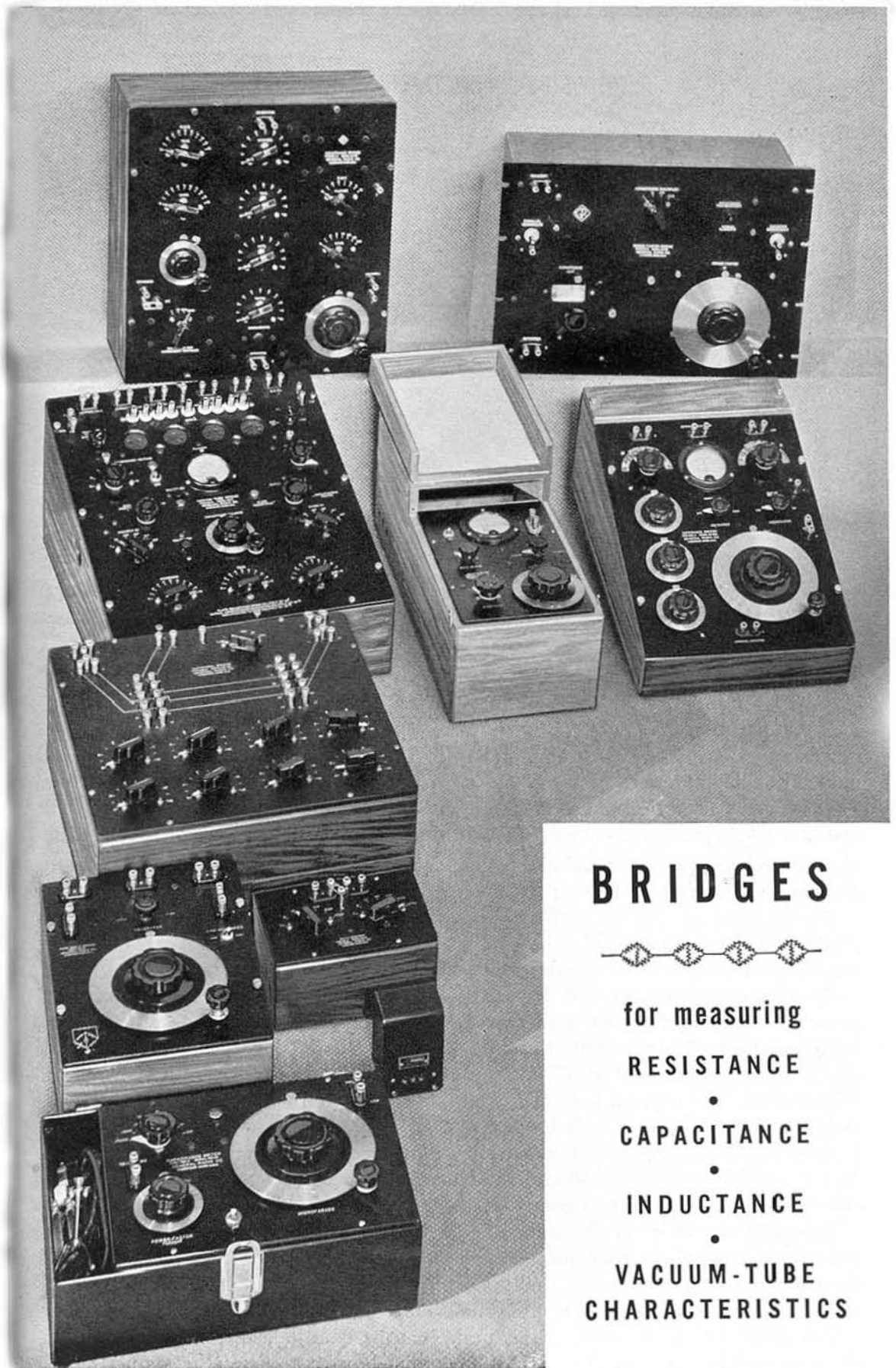

## BRIDGES



for measuring

RESISTANCE

•

CAPACITANCE

•

INDUCTANCE

•

VACUUM-TUBE  
CHARACTERISTICS

## TYPE 650-A IMPEDANCE BRIDGE



FOR THE RAPID MEASUREMENT  
OF RESISTANCE, CAPACITANCE,  
AND INDUCTANCE

A bridge capable of measuring resistance, inductance, and capacitance over wide ranges and which is always set up and ready for operation is a valuable instrument in electrical laboratories.

The TYPE 650-A Impedance Bridge is entirely self-contained, including standard and tone source, and is direct reading over wide ranges of d-c resistance, a-c resistance at 1000 cycles, capacitance and dissipation factor ( $\frac{R}{X}$ ) at 1000 cycles, and inductance and energy factor ( $Q$ ) at 1000 cycles.

Results are read directly from dials having approximately logarithmic scales. The position of the decimal point and the electrical unit in terms of which the measurement is made are indicated by the positions of two selector switches.

Resistances are measured in terms of a standard resistance arm, reactances are measured in terms of a mica condenser standard, similar in construction to the TYPE 505 Condensers. The accuracy of calibration of the dial on which inductance, resistance, and capacitance are read is 1 per cent. This dial may be set with a precision of 0.2 per cent. The over-all accuracy of results is 1 per cent for capacitance and d-c resistance, 2 per cent for inductance. The smallest measurable quantities are 1 milliohm, 1 micromicrofarad, and 1 microhenry. Power is supplied from four No. 6 dry cells which operate a 1000-cycle hummer for a-c measurements. The bridge may also be used with an external generator of any audio frequency.

The particular value of this bridge lies in its complete availability and the speed with which it can obtain such information as the inductance and energy factor of coils, the range of tuning condensers, the capacitance and power factor of filter condensers, and similar information which is often suddenly required in the course of other work.

The simplicity of operation of this bridge can best be judged from an inspection of the panel. The power supply for the self-contained tone source is in the compartment

at the rear of the sloping panel. The actual balancing is done on two dials. In impedance measurements the main dial at the right balances for reactance, and one of the three smaller dials at the left balances for resistance. In resistance measurements only the main dial requires adjustment to obtain bridge balance. The two knobs at the top extend the ranges of the balancing dials by the decimal multiplying factors indicated on the engraved sectors. The bridge dials are direct reading, and the balance is indicated by telephones for the 1000-cycle measurements. A galvanometer for d-c balances is included on the panel.

## SPECIFICATIONS

**Range:** The ranges of the instrument are given in the following table. The numerical values are the readings of the calibrated dials multiplied by the settings of the decade selector switches.

	<i>Minimum</i>	<i>Maximum</i>
<i>Resistance</i>	1 milliohm	1 megohm
<i>Capacitance</i>	1 micromicrofarad	100 microfarads
<i>Inductance</i>	1 microhenry	100 henrys
<i>Dissipation Factor</i> $\left(\frac{R}{X}\right)$	.002	1
<i>Energy Factor</i> $\left(\frac{X}{R} \text{ or } Q\right)$	.02	1000

**Accuracy:** The large direct-reading dial covers two decades, the main decade being spread out over 12 inches (three-quarters of the dial). It may be set to 0.2%.

Accuracy of readings for capacitance and d-c resistance is 1% for the intermediate multiplier decades; for inductance, 2%. The accuracy falls off in the lower ranges because of the extremely small values to be measured. It decreases to 5% for very large values of capacitance and d-c resistance, and to 10% for large values of inductance.

Accuracy of reading for dissipation factor or for energy factor in terms of its reciprocal is either 20% or 0.005, whichever is the larger.

The frequency of the microphone hummer is 1000 cycles to within  $\pm 5\%$ .

**External Generator:** Provision has been made for using an external generator, although its capacitance to ground may introduce some error. Subject to this limitation, the frequency may be varied over a wide range from a few cycles to 10 kc. The reading of the main dial is independent of frequency, while the readings of the energy and dissipation factor dials must be multiplied by or divided by the generator frequency in kilocycles to give the correct values. Provision is made for adding external resistance if it is necessary to increase their ranges.

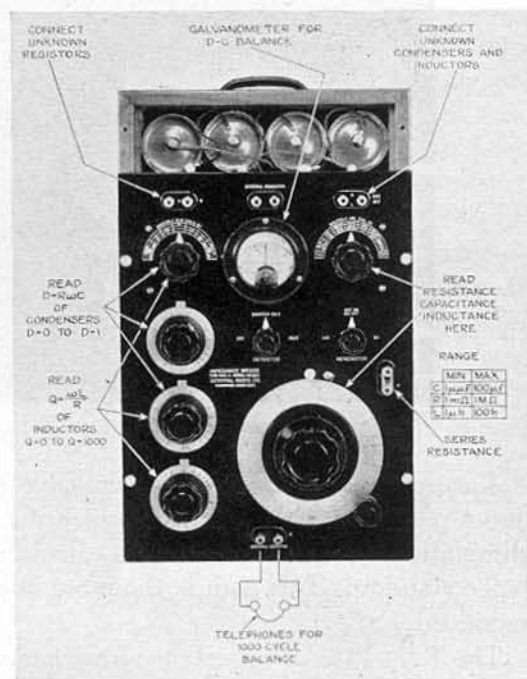

**Power Supply:** Four No. 6 dry cells for the d-c measurements and for driving the microphone hummer are required, and space for them is provided in the cabinet. Batteries are not supplied with the instrument. A higher d-c voltage may be connected to the bridge for high-resistance measurements.

**Other Accessories Required:** Head telephones; Western Electric No. 1002-C are recommended. To increase the sensitivity, a TYPE 814-A Amplifier may be used.

**Mounting:** Black crackle-finish aluminum panel mounted in a shielded walnut cabinet.

**Dimensions:** (Width) 12 x (depth) 20 x (height) 8½ inches, over-all.

**Net Weight:** 22 pounds without batteries; 30½ pounds with batteries.

<i>Type</i>	<i>Code Word</i>	<i>Price</i>
650-A	BEAST	\$175.00*

\*Without batteries or telephones.  
PATENT NOTICE. See Note 17, page v.

## TYPE 716-A CAPACITANCE BRIDGE



A capacitance bridge is most valuable when it has self-contained standards and is direct reading in the quantities which it measures. Considerable time is saved by the elimination of calibration charts, calculations, and connection of an external capacitance standard. This gain is the more important if at the same time accuracy is not sacrificed.

The TYPE 716-A Capacitance Bridge meets these requirements to an unusual degree. It is direct reading in capacitance over the range from  $100 \mu\mu\text{f}$  to  $1 \mu\text{f}$  and in power factor up to 6 per cent (0.06 expressed as a ratio) at a frequency of 1 kilocycle. Its accuracy is  $\pm 2 \mu\mu\text{f}$  or  $\pm 0.2$  per cent for the reading of the standard condenser and  $\pm 0.0005$  or  $\pm 2$  per cent (of dial reading) for power factor.

The wide capacitance range is obtained by providing four sets of ratio arms giving multiplying factors from 1 to 1000 in decade steps. The standard condenser is a TYPE 722 Precision Condenser calibrated to read directly in total capacitance. The capacitance across the unknown terminals is not greater than  $1 \mu\mu\text{f}$ . All capacitances to ground of the input transformer and ratio arms are removed from the capacitance arms by placing them in a shielded compartment insulated from the grounded panel and connected to the junction of the ratio arms.

Power factor is read directly in per cent from the setting of a TYPE 539 Condenser connected across the fixed ratio arm, as is the practice in the Schering bridge. Its 12-inch scale is approximately logarithmic, so that, while having a maximum reading of 6 per cent, its smallest division near zero is 0.01 per cent, thus allowing the estimation of 0.001 per cent. The accuracy of the power factor reading over such a wide capacitance range is made possible by adding capacitance across the lower valued ratio arms, so that the product  $RC$  of all the arms is the same.

For the measurement of capacitances of less than  $100 \mu\mu\text{f}$  and for greater accuracy, substitution methods may be adopted. Terminals are provided so that the unknown



condenser may be connected in parallel with the standard condenser. Capacitances of less than 1000  $\mu\mu\text{f}$  may be measured to an accuracy of  $\pm 2 \mu\mu\text{f}$  or  $\pm 0.2$  per cent. The fixed error may be reduced to  $\pm 0.2 \mu\mu\text{f}$  by the use of a worm correction calibration of the standard condenser.

External standards, precision air condensers and standard mica condensers, may be used in the substitution method by connecting them and the unknown condenser to the unknown terminals. The internal standard then acts merely as the balancing condenser. It is, however, in this respect equivalent to a three-decade mica condenser because of the unequal ratio arms. An external decade resistor may also be used to supplement the power factor dial.

The TYPE 716-A Capacitance Bridge can be used for a wide range of power factor measurements. It will measure directly the power factor of paper condensers having capacitances from 100  $\mu\mu\text{f}$  to 1  $\mu\text{f}$  and all other condensers whose power factors are between 0.1 per cent and 6 per cent. This range will include many samples of solid dielectrics in the form of discs or flat plates and liquid dielectrics when used in large cells. It will measure by the substitution method the power factor of condensers, fixed units, and solid and liquid samples, having capacitances less than 1000  $\mu\mu\text{f}$ , and power factors greater than 0.005 per cent. This range includes mica and air condensers and all dielectric samples for which guard circuits are not needed. Approximately equal condensers having capacitances greater than 1000  $\mu\mu\text{f}$  may be compared to an accuracy of  $\pm 0.2 \mu\mu\text{f}$  or  $\pm 0.02$  per cent in capacitance and 0.00005 or 2 per cent in power factor. This allows the accurate adjustment of condensers to a definite standard, the sorting of groups of condensers, and the intercomparison of primary and secondary standards.

The bridge may be used at frequencies other than 1 kc over the audio-frequency range from 60 cycles to 10 kilocycles. Since the reading of the power factor dial is proportional to frequency, other means for providing the necessary resistance balance, such as a series decade resistor, must be used at both extremes of frequency.

The generator may be connected to the bridge either across the ratio arms through the shielded transformer, which steps up 1 to 4, or between the junction of the ratio and capacitance arms. The voltage applied to the bridge is limited in the former case to 100 volts and in the latter case to 700 volts when the ratio arms are equal.

The bridge is furnished for mounting with its panel vertical on a standard relay rack, upon which may also be mounted the oscillator and amplifier. With no change in shielding, it is also furnished mounted in a walnut cabinet.

#### SPECIFICATIONS

**Ranges:** Direct Reading—capacitance, 100  $\mu\mu\text{f}$  to 1  $\mu\text{f}$ ; power factor, 0.001% to 6%; (0.00001 to 0.06 expressed as a ratio).

Substitution Method—capacitance, 0.1  $\mu\mu\text{f}$  to 1000  $\mu\mu\text{f}$  with internal standard; to 1  $\mu\text{f}$  with external standard.

**Accuracy:** Direct Reading—capacitance,  $\pm 0.2\%$  or  $\pm 2 \mu\mu\text{f}$  x multiplier reading; power factor  $\pm 0.0005$  or  $\pm 2\%$  of dial reading.

Substitution Method—capacitance  $\pm 2 \mu\mu\text{f}$  or  $\pm 0.2\%$ ; power factor,  $\pm 0.00005$  or  $\pm 2\%$  for change in power factor observed.

**Ratio Arms:** The arm across which the power factor condenser is connected has a resistance of 20,000 ohms. The other arm has four values, 20,000 ohms, 2000 ohms, 200 ohms, 20 ohms, providing the four multiplying factors 1, 10, 100, 1000. Suitable condensers are placed across these arms, so that the product  $RC$  is constant.

**Standards:** Capacitance, TYPE 722 Precision Condenser direct reading from 100  $\mu\mu\text{f}$  to 1100  $\mu\mu\text{f}$ ; power factor, TYPE 539-T Condenser calibrated directly in power factor at 1 kc with semilogarithmic scale.

**Shielding:** Ratio arms, power factor condenser, and shielded transformer are enclosed in an insulated shield. The unknown terminals are shielded so that the capacitance across them is not greater than  $1 \mu\mu\text{f}$ . A metal dust cover and the aluminum panel form a complete external shield.

**Frequency Range:** All calibration adjustments are made at 1 kc and the accuracy statements above hold for an operating frequency of 1 kc. The bridge can be used, however, at any frequency between 60 cycles and 10 kc. Power factor readings must be corrected by multiplying the dial reading by the frequency in kilocycles.

**Voltage:** Voltage applied at the GENERATOR terminals is stepped up by a 1-to-4 ratio shielded transformer. A maximum of 25 volts can be applied to the transformer. If desired, power can be applied to the bridge between the junctions of the pairs of

resistance and capacitance arms. With equal ratio arms, a maximum of 700 volts can be applied.

**Mounting:** The bridge is normally supplied for mounting on a 19-inch relay rack. Cabinet mounting can also be supplied.

**Accessories Required:** Oscillator, amplifier, and telephones or rectifier meter. Oscillators are listed on pages 62 to 70. TYPE 814-A Amplifier (see page 71) is recommended.

For substitution measurements, a balancing condenser is needed. This may be either an air dielectric model, such as TYPE 246-L and TYPE 539-C, or a fixed mica condenser of the TYPE 505 series.

**Dimensions:** (Length) 19 x (height) 14 x (depth) 9 inches, over-all.

**Net Weight:** 41 pounds, relay-rack model; 52 pounds, cabinet model.

Type	Description	Code Word	Price
716-AR	For Relay-Rack Mounting . . . . .	BONUS	\$335.00
716-AM	Cabinet Mounted . . . . .	BOSOM	360.00

PATENT NOTICE. See Note 17, page v.

## TYPE 516-C RADIO-FREQUENCY BRIDGE

While bridge methods have been standard practice for direct-current and audio-frequency measurements, bridge circuits suitable for use at high frequencies have not been available. Beyond a vaguely defined limit of about 50 kc, volt-ammeter and resonant methods have yielded somewhat ambiguous results, and there has been a need of some more satisfactory measurement means at these frequencies.

The TYPE 516-C Radio-Frequency Bridge makes possible the measurement of impedance up to a frequency of about 5 megacycles.

The most important single development in connection with the bridge is that of the constant-inductance decade resistor. This device permits compensation of the residual inductance in the resistance arm by means of a constant inductance in an opposite arm, and results in a resistance arm which can be changed in balancing the bridge without introducing any change in the inductance or capacitance relation.

The TYPE 516-C Bridge is direct reading up to 110 ohms and  $1150 \mu\mu\text{f}$ . For the measurement of inductance or of higher values of capacitance, a small fixed condenser may be placed in series with the unknown. When the resistance of the unknown is above 111 ohms a parallel condenser or a combination of series or parallel units can be selected to produce a balance. While in neither of these cases is the bridge direct reading, the necessary calculations are not difficult. The substitution method for capacitance and resistance measurements is recommended where precise results are desired. When the bridge is used as a direct-reading instrument, some accuracy is sacrificed. The over-all accuracy obtainable is, however, extremely good in the range where the bridge is direct reading. Even at frequencies in the vicinity of 5 Mc, the direct-reading accuracy is about 5 per cent. At broadcast frequencies it is about 1 per cent.



A particularly important application of the bridge is in the measurement of antenna characteristics. The bridge method has several advantages over resistance-substitution or resistance-variation methods. These include low power requirements with a general simplicity of the apparatus and procedure. Other types of measurement conveniently made with the bridge include frequency characteristics of radio-frequency coils and chokes, and inductance and power-factor measurements on all classes of impedance at high frequencies.

The accuracy, wide range, and ease of operation of the TYPE 516-C Radio-Frequency Bridge make it the most satisfactory device available for radio-frequency impedance measurement. It should be emphasized, however, that the bridge requires an appreciation of the fundamental problems involved in high-frequency measurement on the part of the user if erroneous results are not to be obtained. Stray capacitance, the reactance of leads, and contact resistance, factors which are negligible at lower frequencies, are often an appreciable part of the impedance measured at radio frequencies. A recognition of the importance of these factors is necessary to a correct interpretation of the results. In the hands of those possessing experience in the technique of high-frequency measurements, this bridge will fill a long recognized need and will give dependable and accurate results.

#### SPECIFICATIONS

**Capacitance Range:** Main dial,  $40 \mu\mu\text{f}$ - $1150 \mu\mu\text{f}$ ; vernier dial,  $\pm 0.1 \mu\mu\text{f}$ - $10 \mu\mu\text{f}$ . The range can be extended indefinitely by using a series condenser.

**Resistance Range:** 0.1 ohm to 111 ohms. The range can be extended indefinitely by using a known condenser in parallel with the unknown.

**Power-Factor Range:** 0.005% to 3% at 1 Mc.

**Frequency Range:** 500 kc to 5000 kc with output transformer furnished. With suitable output transformers and ratio arms (see below), range can be extended down to include audio frequencies.

**Accuracy:** As a direct-reading bridge,  $\pm 5 \mu\text{mf}$  or  $\pm 1\%$  at 1 Mc for measurements of capacitance,  $\pm 0.2 \Omega$  or  $\pm 2\%$  for resistance, and  $\pm 0.001$  or  $\pm 5\%$  for power factor. With substitution methods, greater accuracy can be obtained.

**Accessories Recommended:** The bridge is supplied with 100-ohm ratio arms and a 516-P10 output transformer for the 500-kc to 5000-kc band. A suitable radio-frequency generator and detector are required.

The TYPE 484-A Modulated Oscillator (see page 69) is suggested. As a detector, a radio receiver covering the desired range, or a TYPE 619-C or TYPE 619-D Heterodyne Detector, may be used (see page 45 or Bulletin 11).

**Condensers:** If measurements outside the direct-reading range of the bridge are to be made, plug-in fixed condensers are required. TYPE 505 Condensers are recommended. A set of four of these with capacitances of 100  $\mu\text{mf}$ , 200  $\mu\text{mf}$ , 500  $\mu\text{mf}$ , and 1000  $\mu\text{mf}$ , respectively, is adequate for most purposes. (See page 37.)

**Dimensions:** (Length) 18 x (width) 12 x (height) 8 inches, over-all.

**Net Weight:**  $21\frac{3}{4}$  pounds.

Type	Code Word	Price
516-C	BATCH	\$225.00

PATENT NOTICE. See Notes 3, 10, 17, page v.

## ACCESSORIES FOR TYPE 516-C RADIO-FREQUENCY BRIDGE

By changing the ratio arms and shielded transformer, the frequency range of the TYPE 516-C Radio-Frequency Bridge can be extended downward to frequencies as low as 60 cycles. For a discussion of low-frequency measurements with this bridge, see the General Radio *Experimenter*, Vol. X, No. 10, March, 1936.

Ratio arms and transformers for frequencies other than 1 Mc are listed below. The resistance of the ratio arms is chosen to make the power-factor dial read correctly at the frequency specified.

Transformers are fitted with plug bases to fit the jack plate in the bridge.

For frequencies below 150 kc, the TYPE 814-A Amplifier (page 71), used with a tuned circuit, and the TYPE 726-A Vacuum-Tube Voltmeter (page 116) are recommended for use as the bridge detector.

## RATIO ARMS FOR TYPE 516-C RADIO-FREQUENCY BRIDGE

Type	Resistance	Frequency	Code Word	Price
516-P2	10 $\Omega$	10 Mc	ADAPTORANT	\$6.00
*516-P3	100 $\Omega$	1 Mc	ADAPTORBUG	6.00
516-P4	1 k $\Omega$	100 kc	ADAPTORPIG	6.00
516-P5	10 k $\Omega$	10 kc	ADAPTORTOE	6.00
516-P6	100 k $\Omega$	1 kc	ADAPTORTOP	8.00
516-P7	1667 k $\Omega$	60 c	ADAPTORVIZ	15.00

## SHIELDED TRANSFORMERS

Type	Frequency Range	Code Word	Price
*516-P10	500 kc — 10 Mc	ADAPTORWAY	\$8.00
578-AR	50 c — 10 kc	TABLEMOUNT	20.00
578-BR	20 c — 5 kc	TENORMOUNT	20.00
578-CR	2 kc — 500 kc	TEPIDMOUNT	20.00

\*Furnished with the bridge.



## TYPE 667-A INDUCTANCE BRIDGE



The problem of the accurate measurement of small inductors having low  $Q$  at audio frequencies, such as are used in increasing numbers in modern radio receivers, has not been satisfactorily met by the standard types of bridge circuits which have been available.

Their measurement, when made on the usual type of bridge, is subject to three sources of error: the sliding zero balance occurring when two inductors having energy factors ( $Q$ ) between 0.1 and 10 are compared, the inductance variation of any decade resistor altered in either arm, and the energy factor of the resistance in any bridge arm because of capacitance in parallel with it.

All inductance bridges have been subject to one or more of these errors, but they have been negligible in measurements of large inductances of relatively small resistance. When dealing with small coils of low  $Q$ , however, they may cause errors of several per cent in the measured result.

In the usual inductance bridge the balances for resistance and inductance are not independent. The final balance point, therefore, is not unique and can be recognized only after comparing a succession of balances, *i.e.*, a sliding zero balance is encountered. In the TYPE 667-A Bridge this difficulty is eliminated by placing a small variable inductor in series with the unknown inductance, thus allowing an inductance balance which is entirely independent of the resistance balance.

An inductance-compensated resistor (similar to TYPE 670 Compensated Decade Resistor) is used to eliminate the effect of reactance changes when obtaining the resistive balance. The constant residual inductance of the resistance decades is compensated for by a small change in the standard inductor. The result is a bridge that has independent balance for resistance and inductance, is capable of measuring inductance with an accuracy of 0.1 microhenry, and which is direct reading.

Terminals are provided so that the bridge may be used as a resonance bridge for measurements such as the ratio of a-c to d-c resistance. The d-c resistance can be determined on the bridge by using a battery and galvanometer in place of the usual a-c generator and detector.

Using a substitution method of measurement, inductance standards between 1 millihenry and 1 henry can be intercompared to an accuracy of 0.05 per cent.

## SPECIFICATIONS

**Range:** Inductances from 1 microhenry to 1 henry. This inductance may be associated with a value of  $Q$  as low as 0.06 at 1 kc.

**Accuracy of Measurement:** Inductances can be measured at a frequency of 1 kc with an accuracy of 0.2% or 0.1 microhenry, whichever is the larger. For measurements with the multiplier set at "x 1000," the accuracy is 0.4%.

**Frequency Range:** The frequency range extends from 60 cycles to 10,000 cycles when proper power source and null detector are used.

**Ratio Arms:** One ratio arm consists of 4 values: 1 ohm, 10 ohms, 100 ohms, or 1000 ohms. The other arm is a continuously adjustable decade resistor of 1111 ohms. The self-contained inductance standard

is a 1-millihenry toroid wound on an isolantite form. The resistance standard is a compensated decade resistance with a range of 0 to 111 ohms.

**Shielding:** The cabinet is completely shielded and the bridge arms are shielded from each other. The input transformer is completely shielded.

**Accessories Required:** Power supply — General Radio TYPE 508-A Oscillator recommended; amplifier — General Radio TYPE 814-A recommended; head telephones.

**Mounting:** The instrument is supplied in cabinet mounting only.

**Dimensions:** (Length)  $17\frac{1}{2}$  x (width) 16 x (height)  $9\frac{1}{2}$  inches.

**Net Weight:**  $30\frac{5}{8}$  pounds.

Type	Code Word	Price
667-A	AEIRE	\$325.00

## TYPE 544-A MEGOHM METER

Convenient portable instruments have not previously been available for the direct measurement of high resistances. The equipment available has involved either a sensitive detector in the form of a wall galvanometer, or a high impressed voltage taken from a hand-cranked generator. The application of vacuum-tube methods to this problem has resulted in a materially simplified device. The TYPE 544-A Megohm Meter consists of a resistance bridge having a vacuum-tube voltmeter as the null detector.

The sensitivity is sufficient so that the indicating meter may be a pointer-type galvanometer. The bridge is balanced by means of a logarithmically tapered rheostat calibrated directly in megohms over two decades from 0.1 megohm to 10 megohms. The larger decade from 1 megohm to 10 megohms covers three-quarters of the dial, or  $5\frac{3}{4}$  inches, and provides approximately constant fractional accuracy of reading. Five multiplying factors (0.1, 1, 10, 100, and 1000) are provided by a switch which varies the resistances in two arms of the bridge in decimal steps. The complete range of the bridge is six decades from 0.01 megohm to 10,000 megohms, with a total scale length of 44 inches.

This range of resistance covers most of the high resistances met with in practice. All grid leaks and coupling resistors for vacuum tubes may be measured. The insulation resistance of all low-voltage electrical apparatus, such as motors, transformers, and heating devices; of sufficiently long lengths of high-voltage cables; of paper condensers; and of slabs of most insulators may be determined. The extremely long scale allows the effects of temperature and humidity on insulating materials to be studied.

## SPECIFICATIONS

**Range:** 10,000  $\Omega$  to 10,000 M $\Omega$  covered by a dial and 5-position multiplier switch. Resistances up to 100,000 M $\Omega$  can be measured by indirect methods.

**Accuracy:** To within 3% between 10,000  $\Omega$  and 100 M $\Omega$  and to within 5% between 100 M $\Omega$  and 10,000 M $\Omega$ .

**Dial:** The 2-decade dial is individually engraved. Over the main decade, the scale is approximately logarithmic, thus giving constant fractional accuracy.

**Null Indicator:** Balance is indicated by the zero-center galvanometer on the panel.

**Tubes:** One 32-type, supplied with the instrument.



**Extraneous Voltages:** The megohm meter operates to best advantage on resistors across which there are neither a-c nor d-c voltage drops. The effects of constant amplitude a-c voltages up to about 10 volts, rms, and steady d-c voltages up to about 0.5 volt can be allowed for, but erratic voltage variations and voltages greater than those mentioned above render the instrument inoperative.

**Power Supply (Batteries):** *Filament*, two No. 6 dry cells. *Plate*, two 45-volt block batteries, Burgess No. 5308 or equivalent. Space for mounting all batteries is provided inside the cabinet. Connections are made by a 7-prong plug and coded cable supplied. Batteries are not supplied with the instrument.

**Power Supply (60-cycle ac):** A TYPE 544-P1 Power-Supply Unit that fits the battery compartment can be ordered separately to supply both plate and filament power from a 115-volt line. The one 82-type tube, one 874-type tube, and the line cord required are supplied. *Power Consumption*, about 44 watts. *Dimensions*, 7 $\frac{3}{4}$  x 7 $\frac{3}{8}$  x 5 $\frac{1}{2}$  inches. *Net Weight*, 9 $\frac{1}{4}$  pounds. (See price list below.)

**Mounting:** Mounted in shielded oak cabinet.

**Dimensions:** Cabinet with cover closed, (width) 8 $\frac{1}{2}$  x (length) 22 $\frac{1}{2}$  x (height) 8 inches, over-all.

**Net Weight:** 15 $\frac{3}{4}$  pounds without batteries or TYPE 544-P1 Power-Supply Unit; 26 $\frac{1}{2}$  pounds with batteries; 25 pounds with TYPE 544-P1 Power-Supply Unit.

Type	Description	Code Word	Price
544-A	Megohm Meter . . . . .	ALOOF	\$165.00
544-P1	Power-Supply Unit . . . . .	ALOOFAPACK	35.00

## TYPE 293-A UNIVERSAL BRIDGE

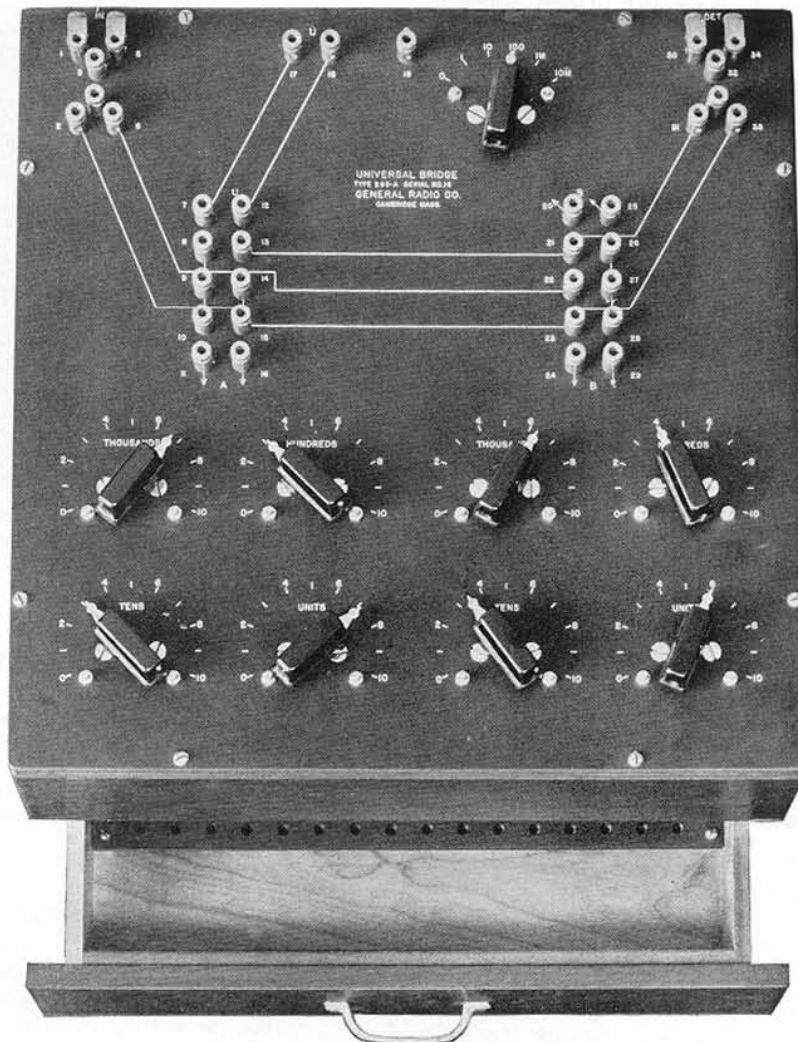

The TYPE 293-A Universal Bridge is designed to present a fundamental circuit which may be connected to produce a wide variety of standard direct- and alternating-current bridges. The instrument consists of three resistance arms and a terminal board by means of which the various circuits can be set up with plugs and jacks. The bridge arrangement permits the measurement of inductance, capacitance, and resistance over a wide frequency range (0-50,000 cycles). It can also be set up as a frequency meter. The instrument has, therefore, a much wider general usefulness in a college or measurement laboratory than the usual form of permanently connected bridge circuit.

The resistance arms of the bridge consist of two similar arms, each having a total resistance of 11,110 ohms in four decade dials (1, 10, 100, and 1000 ohms), and a third arm having resistances of 1, 10, 100, 1000, and 10,000 ohms.

The bridge elements are shown diagrammatically in the accompanying drawing, which illustrates the points in the circuits where terminals are located. The bridge circuit is shown connected for the standard Wheatstone bridge. The dotted lines are



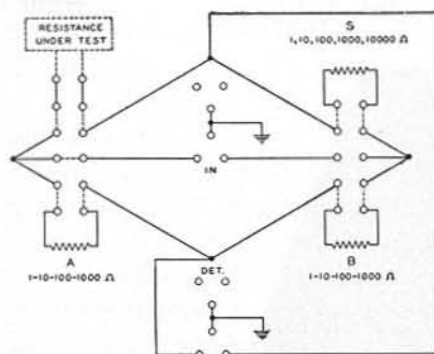

Schematic diagram of a TYPE 293-A Universal Bridge set up for measuring resistance

connections made by means of the plug connectors on the terminal board. The plugs are arranged in two groups, each

group terminating elements of one side of the bridge. The plug arrangement permits the connection of additional elements in series with any of the bridge arms. The input and output (power and null detector) circuits can be brought out directly or through transformers for which plug-in jacks are provided.

When used for resistance measurements no additional standard is required, the *S* arm of the bridge being used as a standard. For inductance and capacitance measurements, an external standard is required. The bridge does not include a null detector or power supply.

### SPECIFICATIONS

**Bridge Arms:** The *A* and *B* arms each consist of four decade resistors covering a range of 1 ohm to 11,110 ohms in 1-ohm steps. The *S* arm is a resistor with 1-, 10-, 100-, 1000-, and 10,000-ohm sections. The characteristics are similar to those of the TYPE 602 Decade-Resistance Box.

**Accuracy:** All resistors are adjusted to within 0.1% of the specified value except the 1-ohm units which are adjusted to within 0.25%.

The absolute accuracy of measurement, of course, will depend upon the accuracy of the standard.

**Frequency Range:** The bridge can be used at all frequencies from direct current up to 50,000 cycles.

**Shielding:** The cabinet is copper lined, and the *A*, *B*, and *S* arms are shielded from each other. The panel is shielded over the *A* and *B* arms.

**Accessories:** To facilitate making the connections required by this flexible bridge, there are supplied with each instrument 10 double plugs, 2 double shielded connector cords, and 2 single cords.

For suggestions as to the choice of suitable standards, sources of power, and null indicators, consult the section on bridge accessories, page 93. Shielded input and output transformers and TYPE 293-P3 Slide-Wire Resistors are described below.

**Dimensions:** Panel, (width)  $15\frac{1}{2}$  x (depth)  $16\frac{3}{8}$  inches. Cabinet, (height)  $8\frac{3}{8}$  inches, over-all.

**Net Weight:** 21 $\frac{1}{2}$  pounds.

Type	Code Word	Price
293-A	BACON	\$140.00

### TYPE 293-P ACCESSORIES

In using the TYPE 293-A Bridge for alternating-current measurements, shielded input and output transformers are desirable. The following transformers are available and are satisfactory for measurements in the audio-frequency range. Both transformers can be used with either coil as input or output.

When the impedance under measurement is low, it is desirable to extend the range of the bridge arms downward. This may be done by the use of one or two TYPE 293-P3 Slide-Wire Resistors, a shielded resistor calibrated directly and having a range of 0-1.3 ohm. The slide-wire calibration is accurate to 0.02 ohm at any setting. The unit is arranged for plug mounting on the bridge terminal board.

Type	Turns Ratio	Inductance High Side	Frequency Range	Circuit Impedance		Net Weight	Code Word	Price
				High Side	Low Side			
293-P1	3:1	2.5 h	50-5000 cycles	2700 Ω	300 Ω	2 lb.	BADGE	\$12.00
293-P2	2.55:1	25 h	50-5000 cycles	25,000 Ω	4000 Ω	2 lb.	BAFFY	12.00
293-P3	Slide-Wire Resistor, 0-1.3 Ω					8 oz.	BAGGY	20.00

## TYPE 561-C VACUUM-TUBE BRIDGE



An important group of measurements ordinarily taken by means of bridge methods is that of the dynamic characteristics of vacuum tubes. These parameters, amplification constant, mutual conductance, and plate resistance, change under the influence of electrode potentials, and the manner in which these changes take place determines the usefulness of the tube for many applications. Both the tube and set manufacturers require a simple and accurate means of obtaining data on these characteristics. TYPE 561-C Vacuum Tube Bridge is designed for these measurements.

The procedure in making measurements is simple and straightforward, and is exactly the same for the three coefficients: amplification factor, plate resistance, and transconductance. A three-position switch is turned to whichever quantity is desired, multiplier switches are set at the appropriate value for the tube being tested, and balance is obtained by adjusting a three-decade attenuator and a variable condenser. At balance the decades read directly, to three significant figures, the quantity being measured.

The three main tube parameters are measured independently, *i.e.*, none of the balances depends in any way on any other so that independent cross checks can be obtained from the known relationship among the three coefficients. Negative values of the tube coefficients may be measured as readily as positive values.

The bridge embodies new measuring circuits and a more satisfactory method of balancing out the effects of the tube inter-electrode capacitances than has heretofore been available. Not only is the accuracy of the measurement thereby considerably

improved, but all three of the usual parameters may be measured independently over a much wider range. For instance, the mutual conductance of a tube having a high value of grid to plate capacitance can be measured without any error from this capacitance.

The measuring circuits and the tube-control circuits may be separated by opening link connectors on the top of the panel. This not only facilitates the testing of tubes associated with other control apparatus, but also makes it possible by changing the cross connections in a very simple manner to measure grid-circuit parameters, or parameters referred to any pair of electrodes.

The tube circuits have large enough current-carrying capacity and sufficient insulation so that low-power transmitting tubes may be tested in addition to receiving tubes.

### SPECIFICATIONS

**Range:** Amplification factor ( $\mu$ ); 0.001 to 10,000.

Dynamic internal plate resistance ( $r_p$ ); 50 ohms to 20 megohms.

Mutual conductance ( $s_m$ ); 0.02 to 20,000 micromhos.

Under proper conditions, the above ranges can be exceeded. The various parameters can also be measured with respect to various elements, such as screen grids, etc. Negative, as well as positive, values can be measured.

**Range of Tubes Covered:** All standard four-, five-, six-, and seven-prong receiving tubes can be measured on this instrument without the use of adapters, except that five-, six-, or seven-prong tubes not having separate heaters require the use of a single TYPE 561-P2 Universal Adapter furnished with the bridge. A switch is provided for switching the control-grid connection from the base to the cap.

An octal adapter is also supplied, by means of which all octal-base tubes, either glass or metal, can be tested with any desired connections to the electrodes.

The Universal Adapter supplied permits the testing of tubes with non-standard base connections. Unmounted tubes are connected directly to the panel binding posts for test measurements.

The tube circuits have large enough current-carrying capacity and sufficient insulation so that low-power transmitting tubes may be tested in addition to receiving tubes. Maximum allowable plate current is 150 milliamperes and maximum plate voltage is 1500 volts.

**Filament Supply Circuits:** A double-range rectifier-type alternating-current and direct-current filament voltmeter and a source of alternating-current heater power are contained in the instrument. No external filament connections need be made for alternating-

current tubes, unless voltage greater than 8 volts or current greater than 3.5 amperes is required. The filament rheostat for direct-current filament supply has a capacity of 750 milliamperes.

When measuring alternating-current heated tubes, the bridge requires connection to a source of 115-volt, 60-cycle alternating current.

**Electrode Voltage Supply:** Batteries or suitable power supplies are necessary for providing the various voltages required by the tube under test.

**Bridge Source:** A source of 1000 cycles is required. The TYPE 508-A Audio Oscillator is suitable for this purpose.

**Null Indicator:** A suitable null indicator is required. The TYPE 814-A Amplifier used in conjunction with a sensitive pair of telephones is recommended for this purpose.

**Constructional Features:** The lower half of the front panel of the instrument contains the special bridge circuit used in measuring the coefficients. The upper half of the panel contains tube sockets, alternating-current filament supply, filament voltmeter, rheostats, terminals for various voltages, and terminals for direct connection of an external tube to the bridge circuit. This arrangement provides the greatest flexibility for general use.

**Mounting:** The instrument is mounted on a black crackle lacquered aluminum panel and is furnished in a polished walnut cabinet. A leatherette cover is supplied to protect the instrument from dust when not in use.

**Dimensions:** (Length)  $18\frac{3}{8}$  x (width)  $15\frac{3}{4}$  x (height) 11 inches.

**Net Weight:** 45 pounds.

<i>Type</i>	<i>Code Word</i>	<i>Price</i>
561-C	BEIGE	\$375.00

PATENT NOTICE. See Note 17, page v.

## TYPE 625-A BRIDGE

This instrument consists of a skeleton bridge circuit, of which one arm contains a 10,000-ohm direct-reading logarithmic rheostat, and the other three arms are brought out to pairs of terminals on the panel, making provision for plugging in standard and unknown units to obtain a variety of circuits. A 1000-cycle a-c voltage source is contained in the bridge. When assembled with the proper standards this bridge substantially duplicates the TYPE 650-A Impedance Bridge in performance.

## SPECIFICATIONS

**Range:** With the recommended accessories the ranges are: for resistance, 1 milliohm to 1 megohm; for capacitance, 1 micromicrofarad to 100 microfarads; for inductance, 1 microhenry to 100 henrys.

**Accuracy:** The accuracy of results depends upon the type of standards used. With the accessories recommended, an accuracy of 2% for measurements of inductance, capacitance, and d-c resistance can be obtained. The accuracy of the component parts of the bridge itself is 1%. The frequency of the microphone hummer is 1000 cycles to within  $\pm 5\%$ .

**Power Supply:** Two  $4\frac{1}{2}$ -volt batteries (Burgess No. 2370, Eveready No. 711, or equivalent) for the d-c measurements, and for driving the microphone hummer, are required, and space for them is provided in the cabinet. Batteries are not supplied with the instrument. An external a-c voltage source having any frequency up to 5000 cycles may be used.

**Accessories Recommended:** In addition to head telephones for a-c measurements and a zero-center, 200- $\mu$ a, full-scale galvanometer for d-c measurements, purchase of the following units is recommended if the full range is to be covered. Omission of some items is possible if narrower ranges are satisfactory.



<i>Resistors</i>	<i>Condensers</i>
1—TYPE 500-A 1 $\Omega$	1—TYPE 505-F 0.001 $\mu$ f
1—TYPE 500-B 10 $\Omega$	1—TYPE 505-L 0.01 $\mu$ f
1—TYPE 500-D 100 $\Omega$	1—TYPE 625-P1 1- $\mu$ f
1—TYPE 500-H 1000 $\Omega$	Condenser
2—TYPE 500-J 10,000 $\Omega$	(Adjusted to within $\pm 2\%$ . Dimensions: $2\frac{3}{8}$ x $1\frac{1}{2}$ x $3\frac{1}{2}$ inches, over-all. Net Weight: 4 ounces.)
1—TYPE 526-B Mounted Rheostat and Potenti- ometer required for Dissipation and Energy Factor Measurements.	

**Mounting:** This instrument is assembled on a black crackle-finish aluminum panel and mounted in a shielded walnut cabinet. A drawer in the lower part of the cabinet provides space for storing the standards suggested.

**Dimensions:** (Width) 9 x (depth) 13 x (height) 7 inches, over-all.

**Net Weight:** 9 pounds without batteries; 11 pounds with batteries.

<i>Type</i>	<i>Description</i>	<i>Code Word</i>	<i>Price</i>
625-A	Bridge . . . . .	BEACH	\$65.00
625-P1	1- $\mu$ f Condenser . . . . .	BAIZE	2.00

PATENT NOTICE. See Note 17, page v.



## TYPE 578 SHIELDED TRANSFORMER



This is an audio-frequency bridge transformer having two shields, one around each winding. The shields are separated by an air gap.

The primary and secondary windings have less than  $0.3 \mu\mu\text{f}$  direct intercapacitance and hence will isolate a bridge from changes of electrostatic potential in the generator circuit. At the same time the correct connection of the shields places a capacitance of only about  $30 \mu\mu\text{f}$  across either the unknown or the standard arm of the bridge in exchange for the large generator-to-ground capacitance that normally exists. The iron core laminations are effectively grounded by means of a copper shield.

The wide frequency range and the fact that the same transformer may be used in either direction adapt this transformer to the requirements of a large proportion of a-c bridge measurements.

A discussion of the characteristics and uses of these transformers appeared in two issues of the *General Radio Experimenter*—April, 1934, and October, 1935. Copies will be sent upon request.

## SPECIFICATIONS

Type	Frequency Range	Impedance Range	
		Primary	Secondary
578-A, -AR, -AT	50 cycles to 10 kc	50 $\Omega$ to 5K $\Omega$	1K $\Omega$ to 100K $\Omega$
578-B, -BR, -BT	20 cycles to 5 kc	60 $\Omega$ to 6K $\Omega$	1K $\Omega$ to 120K $\Omega$
578-C, -CR, -CT	2 kc to 500 kc	20 $\Omega$ to 2K $\Omega$	4K $\Omega$ to 40K $\Omega$

**Ratio:** The transformer has a turns ratio of 4:1. It may be used in either direction.

**Frequency and Impedance Range:** See table.

**Capacitance:** The direct capacitance between primary and secondary windings is less than  $0.3 \mu\mu\text{f}$ ; that between the primary and secondary shields is less than  $30 \mu\mu\text{f}$ .

**Shielding:** Each winding is separately shielded, and a third shield effectively grounds the core laminations.

**Mounting:** Three types of mounting are available: (1) mounted in a Model B case (see page 141) with windings and both shields brought out to soldering lugs; (2) same as (1) with a plug base for use in

# BRIDGES

TYPE 516-C Radio Frequency Bridge; (3) mounted in clamps with no external shield, leads terminated on soldering lugs. This model is for use where external shielding is provided by the user. All three types are illustrated on page 91.

**Dimensions:** Dimensions for Model B case are given on page 141. The over-all height of -R models is  $5\frac{3}{8}$  inches, including plugs. Dimensions for -T models are  $2\frac{3}{4}$  x  $2\frac{3}{4}$  x (height)  $3\frac{1}{8}$  inches, over-all. **Net Weight:** -R models,  $2\frac{3}{4}$  pounds; all others,  $2\frac{1}{2}$  pounds.

Type	Mounting	Code Word	Price
578-A	Model B Case.....	TABLE	\$15.00
578-B	Model B Case.....	TENOR	15.00
578-C	Model B Case.....	TEPID	15.00
578-AR	Plug-in for TYPE 516-C Radio-Frequency Bridge	TABLEMOUNT	20.00
578-BR	Plug-in for TYPE 516-C Radio-Frequency Bridge	TENORMOUNT	20.00
578-CR	Plug-in for TYPE 516-C Radio-Frequency Bridge	TEPIDMOUNT	20.00
578-AT	Without case, in clamps.....	TABLEPLACE	12.50
578-BT	Without case, in clamps.....	TENORPLACE	12.50
578-CT	Without case, in clamps.....	TEPIDPLACE	12.50

## TYPE 610-A RATIO-ARM BOX

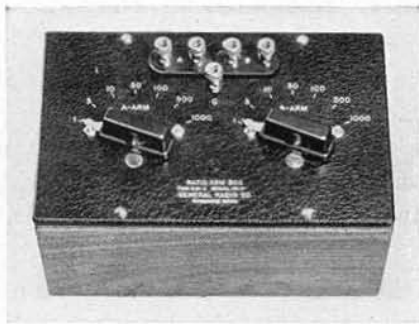

A ratio-arm box is a suitable nucleus around which to design any bridge circuit. It contains a pair of ratio arms giving ratios from 0.001 to 1000 in twelve steps. The switches as well as the individual precision resistance cards used in the ratio-arm box are similar to those employed in the TYPE 602 Decade-Resistance Box. (See description on pages 12 and 13.)

### SPECIFICATIONS

**Resistances:** Each arm, 1, 3, 10, 30, 100, 300, 1000 ohms.

**Type of Winding:** Ayrton-Perry, manganin wire.

**Accuracy:** Correct at box terminals to within 0.25% for 1-ohm and 0.1% for other units, respectively.

**Switches:** TYPE 510-P1, 7-point. Enclosed contacts.

**Mounting:** Switches and terminals mounted on

black crackle-finish aluminum panel and enclosed in a shielded walnut cabinet.

**Terminals:** Jack-top binding posts with separate ground terminal.

**Dimensions:** (Length)  $7\frac{3}{4}$  x (width) 5 x (height)  $5\frac{1}{4}$  inches, over-all.

**Net Weight:**  $3\frac{5}{8}$  pounds.

Type	Code Word	Price
610-A	RABID	\$32.00

## BRIDGE ACCESSORIES

All bridges require for their operation a power source, a null indicator, and comparison standards. Other accessories are transformers for matching the impedances of the power source and null indicator to the bridge, amplifiers, filters, Wagner ground, galvanometer shunt, and separate ratio arms. These accessories are listed in this section with a brief discussion of their relative merits and a reference to the section where they are fully described.

## POWER SOURCES

For single-frequency measurements, TYPE 813-A and TYPE 813-B Audio Oscillators will be found satisfactory; for measurements at a number of fixed frequencies, TYPE 508-A Oscillator is recommended;

TYPE 713-A or TYPE 613-B Beat-Frequency Oscillator should be used where the operating frequency must be continuously adjustable.

<i>Type</i>	<i>Frequency</i>	<i>Power Output</i>	<i>Page</i>	<i>Price</i>
813-A	1000 cycles	20 mw.	68	\$34.00
813-B	400 cycles	20 mw.	68	36.00
508-A	{200, 300, 400, 600, 800, 1000, 1600, 2000, 3000, and 4000 cycles}	0.5 watt	67	120.00
713-A	10-20,000 cycles	2 watts	62	485.00
613-B	10-11,500 cycles	15 mw.	64	210.00

## STANDARDS AND BALANCING REACTANCES

The TYPE 602 Decade-Resistance Boxes, TYPE 525 Resistors, TYPE 500 Resistors, TYPE 106 Standard Inductances, TYPE 722 Precision Condensers, and TYPE 509 Standard Condensers may be used

as primary standards. The other reactances listed below may be calibrated in terms of these standards or used as balancing reactances in substitution methods.

<i>Instrument</i>	<i>Page</i>	<i>Price</i>
TYPE 602 Decade-Resistance Box.....	12	\$25.00-\$70.00
TYPE 500 Resistor.....	22	2.00
TYPE 525 Resistors.....	23	8.00
TYPE 106 Standard Inductances.....	41	25.00- 36.00
TYPE 107 Variable Inductors.....	42	35.00- 40.00
TYPE 219 Decade Condensers.....	39	32.00- 42.00
TYPE 722 Precision Condensers.....	30	85.00-195.00
TYPE 246 Condensers.....	32	38.00- 54.00
TYPE 539 Condensers.....	33	22.00- 24.00
TYPE 505 Condensers.....	37	3.50- 20.00
TYPE 509 Standard Condensers.....	36	12.50- 48.00

## NULL INDICATORS

Head telephones are the most satisfactory null indicators, both because of their great sensitivity and because of the ability of the human ear to discriminate between a fundamental tone, its harmonics, and noise. They are highly selective, with a

resonant frequency around 1 kc. This prevents their use below 200-400 cycles. The TYPE 726-A Thermionic Voltmeter may be used over the whole range of audio frequencies and most radio frequencies, but is much less sensitive than other null detectors and is

not selective. The TYPE 636-A Wave Analyzer is an extremely selective and sensitive null detector for constant-frequency audio signals.

Oxide-rectifier voltmeters may be used as null detectors over the entire audio-frequency range. The TYPE 483-C (20,000 ohm) Output Meter is particularly recommended.

An amplifier is generally needed to increase the sensitivity when using any form of visual null indicator, and the use of an amplifier is advised for precise measurements even when using telephones. The TYPE 814-AM Amplifier has been designed for this purpose. The TYPE 714-A Amplifier is also suitable.

<i>Instrument</i>	<i>Range</i>	<i>Page</i>	<i>Price</i>
Western Electric Head Telephones (W. E. Type Number 1002-C).....	200 cycles-10,000 cycles	...	\$12.00
TYPE 726-A Vacuum-Tube Voltmeter.....	20 cycles- 50 Mc	116	160.00
TYPE 636-A Wave Analyzer.....	20 cycles-16,000 cycles	107	490.00
TYPE 483-C Output Meter.....	10 cycles-10,000 cycles	122	54.00
TYPE 814-AM Amplifier.....	50 cycles-50,000 cycles	71	97.50
TYPE 714-A Amplifier.....	5 cycles-50,000 cycles	73	190.00

## TRANSFORMERS AND FILTER SECTIONS

The TYPE 578 Shielded Transformers are used to eliminate the effect of transformer or generator capacitances across the bridge arms. The TYPE 666-A Variable-Ratio Transformer is designed for matching the power source and null detector to a bridge. The TYPE 585-R Transformer is a unity-

ratio transformer designed primarily as a line-isolating transformer, but is suitable for use with many bridges. TYPE 830 Filter Sections may be connected between the bridge and null detector to suppress harmonics and ground noise.

<i>Instrument</i>	<i>Page</i>	<i>Price</i>
TYPE 578 Shielded Transformers.....	91	\$15.00
TYPE 666-A Variable-Ratio Transformer.....	144	12.50
TYPE 585-R Transformer.....	144	6.00
TYPE 830 Filter Sections.....	114	18.50-21.50

## WAGNER GROUNDS

Since a Wagner ground of the resistance type is merely a fixed resistance with a variable tap, the TYPES 471, 314, 371, 214, 410, and 301 Potentiometers may be used as Wagner grounds. With

slight alterations TYPES 334-Z or 335-Z Condensers, having balanced sections, become satisfactory Wagner grounds of the capacitance type.

<i>Instrument</i>	<i>Page</i>	<i>Price</i>
TYPE 526 Mounted Rheostat-Potentiometer.....	27	\$8.50
TYPES 471-A and 314-A Rheostat-Potentiometers.....	129	6.00, 4.00
TYPES 371 and 214-A Rheostat-Potentiometers.....	128	4.00, 1.50
TYPES 410-A and 301-A Rheostat-Potentiometers.....	131	1.00, 1.00-1.50
TYPES 334-Z and 335-Z Variable-Air Condensers.....	133	10.00, 6.00



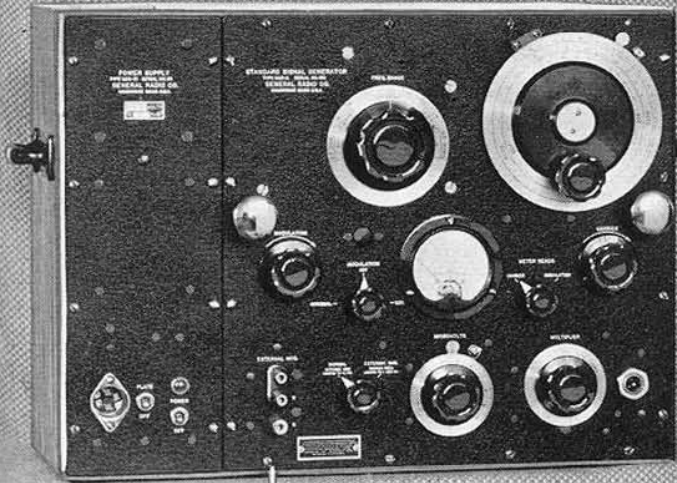

## STANDARD-SIGNAL GENERATORS



for RECEIVER TESTING, FIELD INTENSITY  
MEASUREMENTS, AND GENERAL-PUR-  
POSE USE AT ALL RADIO FREQUENCIES

## TYPE 605-A STANDARD-SIGNAL GENERATOR



Radio-receiver testing requires a source of accurately known radio frequency voltage. The standard-signal generator, which is the accepted instrument for this purpose, consists fundamentally of a carrier-frequency oscillator, a modulating oscillator, and a means for measuring and continuously varying the output voltage and the percentage of modulation.

Although satisfactory technical performance is a primary requirement, ease of operation and price are, to the user, equally important, and the TYPE 605-A Standard-Signal Generator has been designed to satisfy all three requirements.

The frequency range covered by this instrument extends from 9.5 kilocycles to 30 megacycles without the use of plug-in coils. This range is covered in seven bands, selected by means of a switch. The tuning condenser dial is direct reading over this range to an accuracy of 1 per cent, with the exception of a small portion of the highest frequency range, for which a correction curve is supplied.

Both the inductance and the capacitance in the tuned circuit of the carrier oscillator are provided with trimming adjustments, making it possible to compensate for long-period drifts in the calibration, if necessary. Silver contacts are used on the band-change switch, and a positive detent mechanism is provided.

Frequency modulation and reaction of attenuator setting on carrier frequency have been practically eliminated through the use of an aperiodically-coupled buffer amplifier between the carrier oscillator and the attenuator. Modulation, which is accomplished in the grid circuit of the amplifier tube, is variable up to a maximum of 50 per cent. An internal 400-cycle modulating oscillator is provided, and external modulation can also be used. The external modulation characteristic is flat from 30 to 15,000 cycles.

Both carrier level and modulation percentage are measured with a vacuum-tube voltmeter—a distinct advantage over the fragile thermocouples frequently used. A single indicating meter is used, which can be switched from one voltmeter tube to the other as desired.

The output level is controlled by a resistive attenuator consisting of a constant-impedance Ayrton-Perry-wound slide-wire and a ladder-type multiplying network.



## TYPE 604-B TEST-SIGNAL GENERATOR



The development of receiving equipment for use in the higher frequency bands has resulted in the need for a suitable source of test voltage at the very high frequencies.

The general considerations surrounding work at these frequencies suggested that an instrument of high precision would not be justified because of the controlling effect of lead impedances and similar factors. It was decided, therefore, to design a rugged instrument of high reliability which would give reproducible results but not necessarily possess a high absolute accuracy, and which would have a low cost.

The TYPE 604-B Test-Signal Generator was designed with these considerations in mind. It operates at frequencies from 3 megacycles (100 meters) to 100 megacycles (3 meters).

The unit consists of the elements which have become familiar in this type of apparatus: a modulated radio-frequency oscillator, a meter for reading the voltage impressed on the attenuator, and an attenuator, in this instance composed of capacitance elements.

Self-modulation at 400 cycles is provided for, as well as external modulation. Provision is made for an unusually high modulation band (200 kc), which makes this signal generator a suitable source for examination of receivers intended for operation in television systems.

The capacitance attenuator was selected because of its small frequency error and simplicity of construction. It is built in two sections, the first of which reduces the voltage from 10 volts to 1 volt for the rod antenna. The second section delivers an output voltage adjustable between 5 microvolts and 10,000 microvolts which is available at the usual panel-output shielded jack terminal. The rod antenna is sectionalized into such lengths as to produce field strengths in the ratio of 1, 10, and 100. The total antenna length is 15 inches.

The TYPE 604-B Test-Signal Generator is thoroughly shielded, and the stray field is insufficient to affect the accuracy of any measurement on a receiver whose sensitivity lies within the output voltage range of the instrument.

Within the audio-frequency range the percentage modulation is set by the grid-current micro-ammeter. At higher modulating frequencies the voltage applied to the external modulation terminals is to be set to a value to be taken from a calibration chart furnished with the instrument. The normal modulation percentage is 30 per cent. Input impedance of the external modulation terminals is about 5000 ohms at audio frequencies.



## SPECIFICATIONS

**Carrier-Frequency Range:** 3 Mc to 100 Mc, covered with 13 plug-in inductors supplied with the instrument. Special inductors can be built to order for frequencies as low as 300 kc. Prices on request.

**Output:** Capacitance-type attenuator furnishes continuously adjustable voltage from 5 to 10,000 microvolts. A rod antenna in three sections provides field strengths in the ratio of 1, 10, and 100. The input to the antenna is constant at 1 volt.

**Accuracy of Output Voltage:** The accuracy of the voltage at the antenna terminal up to frequencies of 10 megacycles is  $\pm 5\%$ ; up to frequencies of 30 megacycles,  $\pm 20\%$ . The accuracy of the voltage at the OUTPUT terminal up to 10 megacycles is  $\pm 10\%$ ; up to 30 megacycles,  $\pm 30\%$ ; above 30 Mc, no brief statement as to the voltage accuracy would be useful, since the error introduced by connecting any lead to the output of the generator is much greater than that inherent in the instrument itself.

**Modulation:** The internal modulating oscillator is

adjusted to 400 cycles ( $\pm 5\%$ ). External modulation circuit passes frequencies up to 200 kc. Input impedance, 5000 ohms. Voltage required, approximately 6 volts for 30% modulation.

**Accessories:** A shielded connecting cable and 13 inductors with storage rack are provided, as well as an antenna which is in three sections.

**Tubes:** Two 31-type tubes are supplied.

**Power Supply:** Two No. 6 dry cells and four 45-volt Burgess No. 5308 batteries or equivalent. Batteries are not supplied with the instrument.

**Mounting:** The unit is mounted on a black crackle aluminum panel and placed in a shielded walnut cabinet. Space has been provided inside the cabinet for batteries and inductor storage rack.

**Dimensions:** (Width)  $18\frac{3}{4}$  x (height) 9 x (depth)  $16\frac{1}{2}$  inches.

**Net Weight:** 42 pounds, without batteries;  $57\frac{1}{4}$  pounds, with batteries.

Type	Code Word	Price
*604-B	DENSE	\$315.00
Frequency Calibration (per Inductor)		3.00

\*Frequency calibrations supplied only when specifically ordered with the instrument. Use code word DENSECURVE when the entire set of 13 inductors is to be calibrated.

PATENT NOTICE. See Notes 1 and 3, page v.

## TYPE 418 DUMMY ANTENNA



For many receiver tests an artificial or dummy antenna must be used to simulate the characteristics of a typical receiving antenna. TYPE 418-D and TYPE 418-E Dummy Antennas are designed in accordance with the specifications of the Institute of Radio Engineers. TYPE 418-D is intended for use in the normal broadcast band (550 to 1500 kc). The effective height is 4 meters. TYPE 418-E is designed for use at high frequencies. TYPE

418-F places 1.11 ohms in parallel with the normal 10-ohm output impedance of a standard-signal generator which allows the output to be introduced in series with a loop antenna for either receiver testing or field intensity measurement. The output of the generator is thereby reduced by a factor of 10.

Mechanically, the TYPE 418 Dummy Antenna is designed to minimize the difficulties of making connections. One end plugs directly into the output jack of a TYPE 605-A or a TYPE 604-B Standard-Signal Generator. The output cord supplied with the generator plugs into the other end.

# SIGNAL GENERATORS

## SPECIFICATIONS

**Circuit Constants:** TYPE 418-D, 200  $\mu\text{mf}$ , 20  $\mu\text{h}$ , and 15  $\Omega$  connected in series; TYPE 418-E, 400  $\Omega$ , series; TYPE 418-F, 1.11  $\Omega$ , shunt connected.

**Mounting:** Plug terminal to fit the output jack of

General Radio standard-signal generators at one end, output jack at the other.

**Dimensions:** (Length)  $4\frac{1}{8}$  x (diameter)  $1\frac{3}{8}$  inches, over-all.

**Net Weight:** 6 ounces.

<i>Type</i>		<i>Code Word</i>	<i>Price</i>
418-D	.....	EPHOD	\$10.00
418-E	.....	DEUCE	10.00
418-F	.....	DICER	10.00

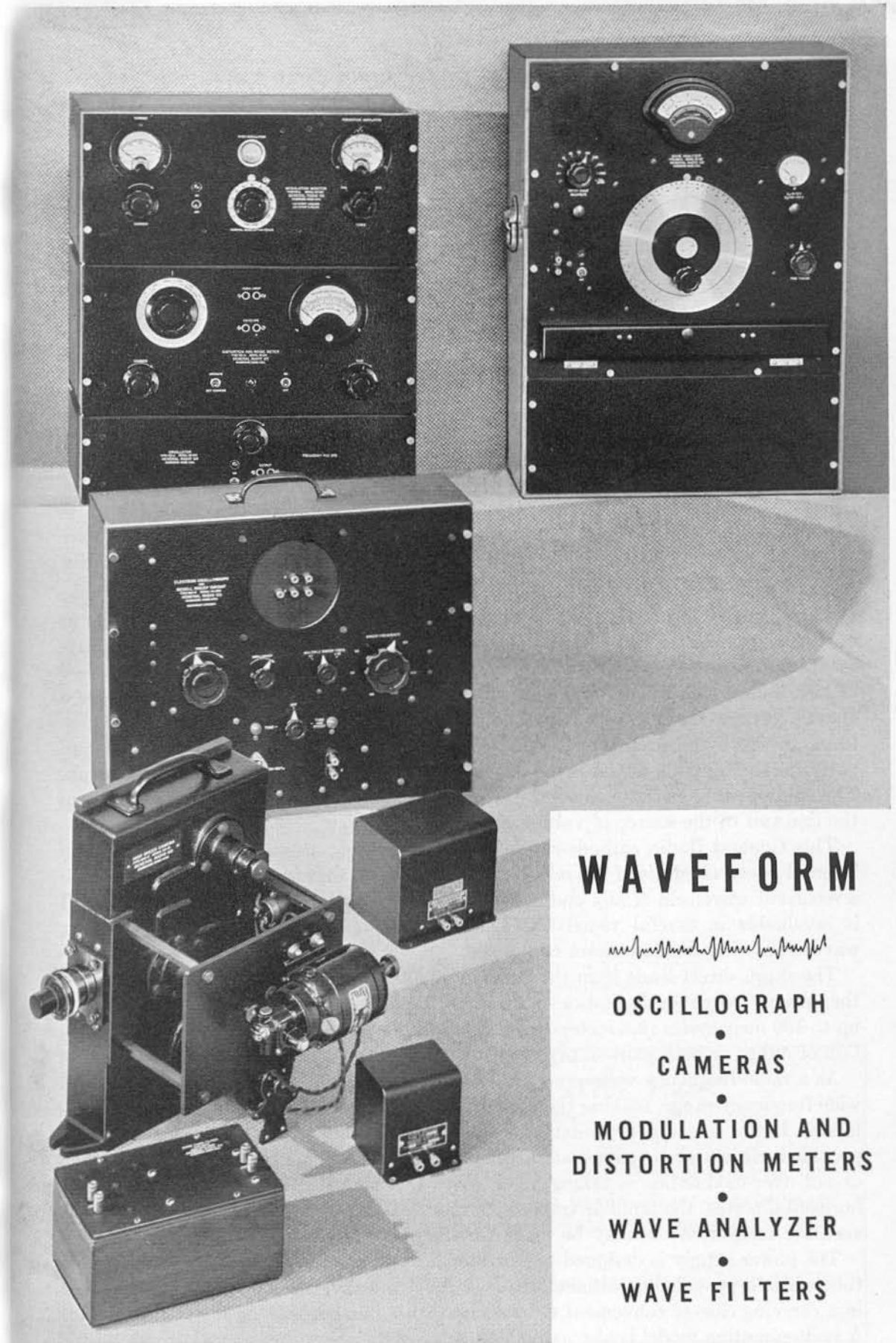

# WAVEFORM

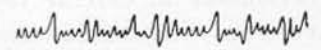

OSCILLOGRAPH

•  
CAMERAS

•  
MODULATION AND  
DISTORTION METERS

•  
WAVE ANALYZER

•  
WAVE FILTERS

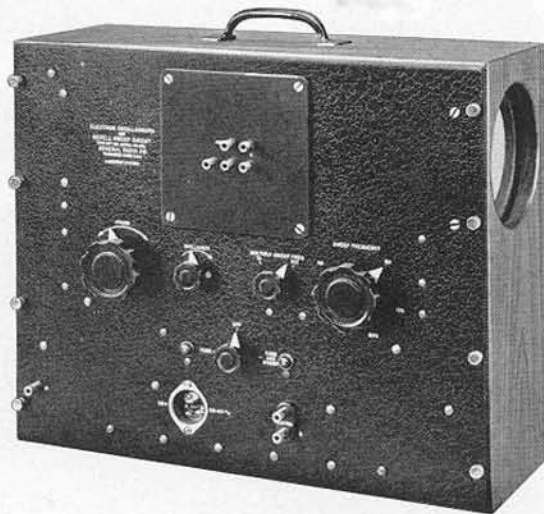
TYPE 687-B ELECTRON OSCILLOGRAPH  
AND BEDELL SWEEP CIRCUIT

The TYPE 687-B Electron Oscillograph is designed to present in a simple, portable, and inexpensive form all of the elements required for using the cathode-ray tube as an oscillograph. The unit includes a power supply providing for all voltage requirements as well as a sweep circuit which furnishes a saw-tooth deflecting voltage.

This instrument will be found to meet the great majority of requirements for a general-purpose oscillograph. It can be used in the examination of all types of waveform. In this application the sweep circuit is connected to the horizontal plates and performs the function of the revolving mirror in the mechanical type of oscillograph. The equipment is as convenient to use as a voltmeter. It requires only connection to the line and to the source of voltage which is being examined.

This General Radio cathode-ray oscillograph has two particular advantages. The internal sweep circuit is of the self-synchronizing type, that is, it will lock in step with a recurrent waveform of any audio frequency. The steady screen pattern so obtained is invaluable in careful visual study, measurement, and photography of complex waveforms with simple camera equipment.

The short, direct leads from the deflecting-plate cap terminals to the panel remove the normal frequency limitations and make the oscillograph ideal for measurements up to 130 megacycles (2.3 meters). These accessible panel terminals permit the operation of either or both pairs of plates balanced or unbalanced to ground.

As a radio-frequency voltmeter the deflection sensitivity is constant over the same wide frequency range, making the oscillograph ideally suited for modulation measurements. If the linear sweep circuit is used, a continuous check upon modulation is provided, since a single glance at the modulation-envelope pattern will show whether or not over-modulation is taking place. With the modulating voltage applied to the horizontal plates, the familiar trapezoidal modulation patterns are obtained on which accurate measurements may be made for steady state conditions.

The power supply is designed to provide all necessary voltages for the cathode-ray tube which is provided as initial equipment. Mechanically, the equipment is assembled in a carrying case of convenient dimensions with a handle, making it easily portable. A rack-mounting model is also available.



## SPECIFICATIONS

**Tube:** All tube specifications are the manufacturers' latest published data. TYPE 687-P1 is equivalent to RCA-905 and TYPE 687-P2 is equivalent to RCA-907, both made by the RCA Manufacturing Company.

**Fluorescent Screen:** A so-called fast-screen tube (TYPE 687-P2) will be furnished unless otherwise specified. This type of screen has a bluish fluorescence, is recommended for photography, and is essential when rapid transients are involved, or for use with the Class 651-A-E Camera Assembly for photographing transients or non-recurrent waveforms. A TYPE 687-P1 slow-screen tube (greenish fluorescence) can be supplied at a slightly lower price, but is not suitable for use with the moving-film camera.

**Screen Diameter:** 5 inches.

**Voltage Sensitivity:** Approximately 75 volts per inch (vertical), 90 volts per inch (horizontal).

**Impedance of Deflecting Plates:** Capacitance is approximately 15 micromicrofarads between deflection terminals (measured at the instrument panel).

**Frequency Characteristics:** The circuits of the deflecting plates show no appreciable frequency effects below 130 megacycles.

**Power Supply:** All voltages necessary are obtained from the self-contained power supply. These are *Anode Voltage*, 1500 volts; *Focusing Anode Voltage*, 0 to 400 volts, positive; *Grid*, 0 to -40 volts; *Heater*

*Voltage*, 2.5 volts; *Heater Current*, 2.1 amperes. The power supply operates from the 115-volt, 50-60 cycle, a-c line. It draws 50 watts when the sweep circuit is operating and 20 watts when the sweep circuit is not operating.

**Terminals:** Jack-top binding posts, mounted on the panel of the oscillograph as shown in the illustration.

**Tubes Required:** The following tubes are required and are supplied as initial equipment: one 80-type, one 885-type, one 58-type, one 879-type, and one General Radio TYPE 687-P2 (RCA-907).

**Sweep Circuit:** Self-contained Bedell Sweep Circuit range: 30 to 3000 sweeps per second, permitting observation of frequencies up to about 21,000 cycles. Sweep is stabilized, requiring a control voltage of 5 to 100 volts rms. Impedance of the control circuit is about 200,000 ohms.

**Mounting:** TYPE 687-BM is mounted in a walnut case with carrying handle. There is an opening for the tube screen at one end of the case. The control panel is situated at the side. A relay-rack mounting model, TYPE 687-BR is also available on special order.

**Dimensions:** TYPE 687-BM, (length) 19 $\frac{5}{8}$  x (width) 8 $\frac{1}{4}$  x (height) 17 $\frac{3}{4}$  inches, over-all. TYPE 687-BR, (length) 19 x (height) 15 $\frac{3}{4}$  x (depth behind panel) 19 $\frac{1}{2}$  inches, over-all.

**Net Weight:** TYPE 687-BM, 37 $\frac{1}{4}$  pounds; TYPE 687-BR, 33 pounds.

Type	Description	Code Word	Price
687-BM	Cabinet Model . . . . .	CRISP	\$184.00
*687-BR	Relay-Rack Model . . . . .	CALIF	224.00

Prices \$4.00 less with TYPE 687-P1 Tube.

\*Not carried in stock.  
PATENT NOTICE. See Note 4, page v.

### REPLACEMENT TUBES

Type	Description	Code Word	Price
687-P1	Slow-Screen Tube (green) . . . . .	ACCESSOBOY	\$40.00
687-P2	Fast-Screen Tube (blue) . . . . .	ACCESSOCAT	44.00

## OSCILLOGRAPH AMPLIFIER (TYPE 714-A)

See page 73 for specifications

In many applications it is found desirable to increase the voltage under observation before applying it to the deflecting plates of an electron oscillograph. The amplifier used for this purpose must be of high input impedance and excellent frequency characteristic if the advantages of the electron type of oscillograph are not to be sacrificed.

The TYPE 714-A Amplifier has been designed for use with the TYPE 687-B Electron Oscillograph.

## CLASS 651 CAMERA ASSEMBLIES

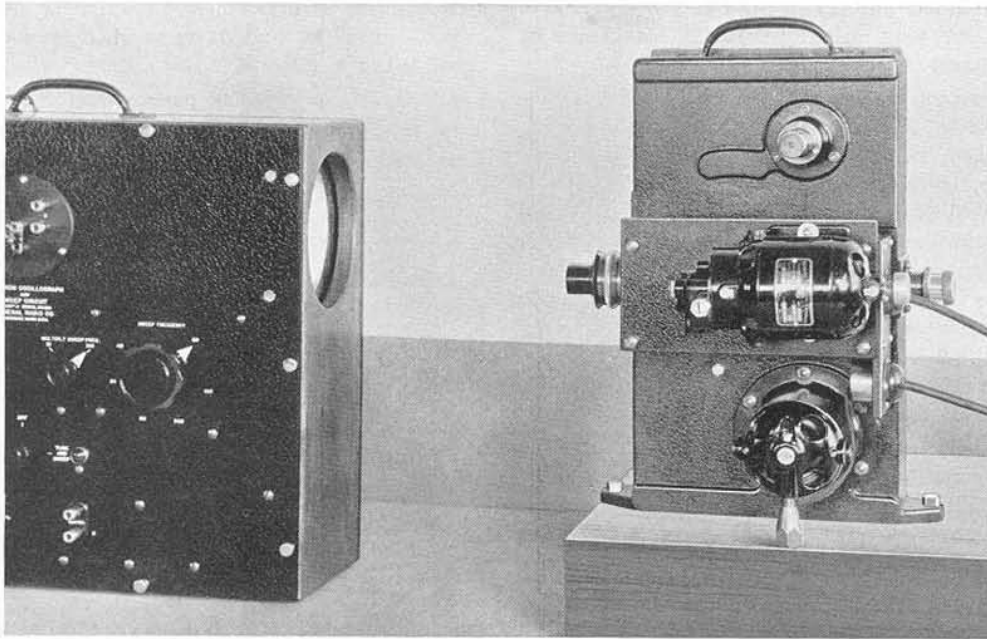

The high film speeds at which the new continuous-film camera will operate make it possible to take cathode-ray oscillograms of high-frequency transients. The photograph shows the CLASS 651-A-E Camera Assembly and a TYPE 687-A Electron Oscillograph and Bedell Sweep Circuit

The many applications of high-speed photography to industrial research have prompted the manufacture of a new continuous-film camera based on the designs of Professor Harold E. Edgerton of the Massachusetts Institute of Technology. Originally designed to photograph rapid mechanical actions by the light from an Edgerton Stroboscope for subsequent projection at normal speed to give the effect of slow motion, the camera is also ideal for recording high-speed transients with a cathode-ray oscillograph.

The General Radio camera differs from conventional motion-picture cameras in its lack of a shutter and intermittent film feed and in its ability to drive at speeds as high as 85 miles per hour (2000 frames per second) without damage to the film. Careful attention to the dynamical design of all moving parts has made this possible. Separate motors are used to drive the film and the take-up reel on which the exposed film is wound. Provision has been made for operation at different film speeds over a wide range so that the new camera can be made to fill almost every research need for a moving-film camera.

The two types of assembly listed will meet most of the usual applications. The A-E group is designed for medium speeds, while the A-M assembly offers a camera suitable for extremely high film speeds. Interchangeable motors provide wide speed ranges, and a number of commercial lenses may be fitted to meet inflexible conditions without departing from the standard camera design.

Special assemblies to meet particular requirements can be built to order.

## CLASS 651-A-E CAMERA ASSEMBLY

This assembly is recommended for low- and medium-speed work. It is the one that would ordinarily be used for making records with a cathode-ray oscillograph, but it can also be used for medium-speed stroboscopic photography. Those interested in the latter use should, however, submit their requirements to the General Radio Company for suggestions before coming to a final decision.

The illustration on this page shows the TYPE 651-A High-Speed Camera of the CLASS 651-A-E Camera Assembly, illustrated on the opposite page, with its slide removed to show the internal design. The manner in which the camera is focused and in which the film is threaded is shown by the illustration. The large central driving sprocket and the bottom take-up reel are each driven by separate motors. The type of main-sprocket drive determines the assembly class letter to which the camera belongs. The camera is focused by viewing the image through the focusing eyepiece when the two apertures in the driving sprocket are aligned as shown. The image forms on a small piece of translucent film inserted in the gate.

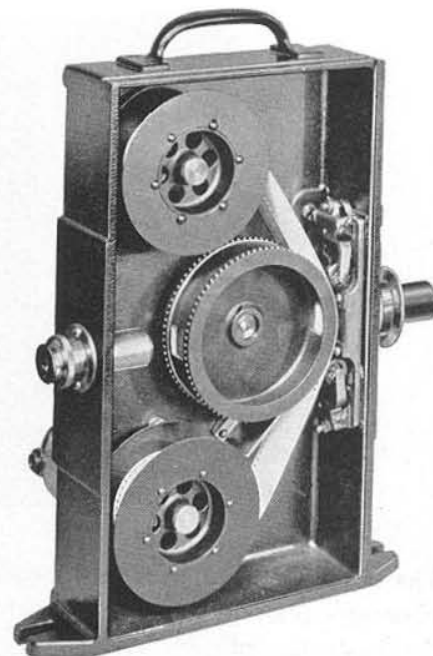

Interior View of the High-Speed Camera

## SPECIFICATIONS

**Film:** Any 35-mm film or paper with standard perforations can be run. Daylight loading and unloading with negligible waste. Capacity of reels, 100 feet.

**Film-Speed Range:** When the motors are operated at the voltages mentioned in "Power Supply" below, film speeds between 3 feet per second and 35 feet per second are obtainable.

**Lens System:** Lens must be purchased separately. An  $f/2.5$ , 47-mm lens from the Bell and Howell "Eyemo" series is available in an adjustable mounting that permits focusing for distances between 8 and 20 inches. The image for focusing is observed directly on the equivalent of a ground glass in the plane of the film.

The lens is sufficiently "fast" to permit the recording of traces from a TYPE 687-A Electron Oscillograph on super-sensitive panchromatic film at a

speed of 35 feet per second, when the ratio of total length along the trace to length of film is less than 5 to 1.

**Drive System:** The film-drive sprocket is driven through a reducing gear by a universal (a-c or d-c) motor. The take-up reel on which the exposed film is wound is driven by a second universal motor.

**Power Supply:** The wide range of film speeds is obtained by applying voltages between 50 volts and 230 volts to both the driving and take-up motors. When 115-volt or 230-volt 50- to 60-cycle service is available, voltage control over the entire range can be obtained by using a Variac. When d-c service only is available, a rheostat must be used.

**Dimensions:** (Length)  $11\frac{7}{8}$  x (width)  $6\frac{1}{2}$  x (height)  $16\frac{1}{2}$  inches, over-all.

**Net Weight:** 32 pounds.

Class	Description	Code Word	Price
*651-A-E	Camera Assembly .....	DINER	\$410.00
651-P1	Lens, Bell and Howell, $f/2.5$ .....	DIARY	91.00

\*Consists of camera (including take-up motor) and driving motor, as described, but without lens.

CLASS 651-A-M CAMERA ASSEMBLY

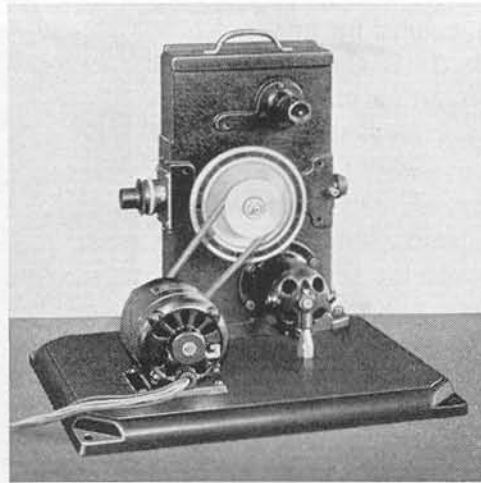

The Class 651-A-M Camera Assembly is designed particularly for super-high-speed stroboscopic photography where the film is later to be printed and projected for study or demonstration purposes. At maximum film speed this equipment gives "slow-motion" results in the ratio of about 120 to 1 when compared with the original action.

Inasmuch as the camera is of the shutterless continuous-film type, an intermittent flashing light source is required to produce the individual exposures. Because of the speeds involved, a TYPE 621 Edgerton Power Stroboscope, illustrated on page 2, is recommended for the source of illumination.

Where high-speed films are to be projected to give slow-motion action, provision for accurately framing the separate exposures is required. A commutator is provided for this purpose. Mounted on the shaft of the main film-drive sprocket, it is connected to the stroboscope circuit and provides the impulse which sets off the flash for each exposure. The exposures are thus accurately spaced on the film, and the film may be projected, without jumping of the image, using standard projection equipment.

SPECIFICATIONS

**Film:** Any 35-mm perforated film or paper can be run. Capacity of reels, 100 feet.

**Film Speed:** Using the 3/4-inch masking gate and the commutator supplied with the assembly, 1200 standard-size frames per second are exposed with a motor speed of 3600 r.p.m. giving a linear speed for the film of about 75 feet per second.

**Lens System:** Lens must be purchased separately. An *f*/2.5, 47-mm lens from the Bell and Howell "Eyemo" series is available in an adjustable mounting that permits focusing for distances between 8 and 20 inches.

**Drive System:** The drive motor is a 115-volt, 3600 r.p.m., 60-cycle, 3-phase, induction motor that drives the sprocket through a 1-to-1 belt drive. The take-up motor is a 115-volt universal motor.

If the film is to be projected, a commutator is required. The commutator supplied is for full-size, 3/4-inch frames.

**Dimensions:** Camera, (length) 11 7/8 x (width) 6 1/2 x (height) 16 1/2 inches, over-all; base, (length) 18 x (width) 15 x (height) 1 1/2 inches, over-all.

**Net Weight:** 60 pounds.

Class	Description	Code Word	Price
*651-A-M	Camera Assembly	DIRGE	\$490.00
651-P1	Lens, Bell and Howell, <i>f</i> /2.5	DIARY	91.00

\*Consists of camera (including take-up motor), driving motor, base, commutator, as described, but without lens.



## TYPE 636-A WAVE ANALYZER

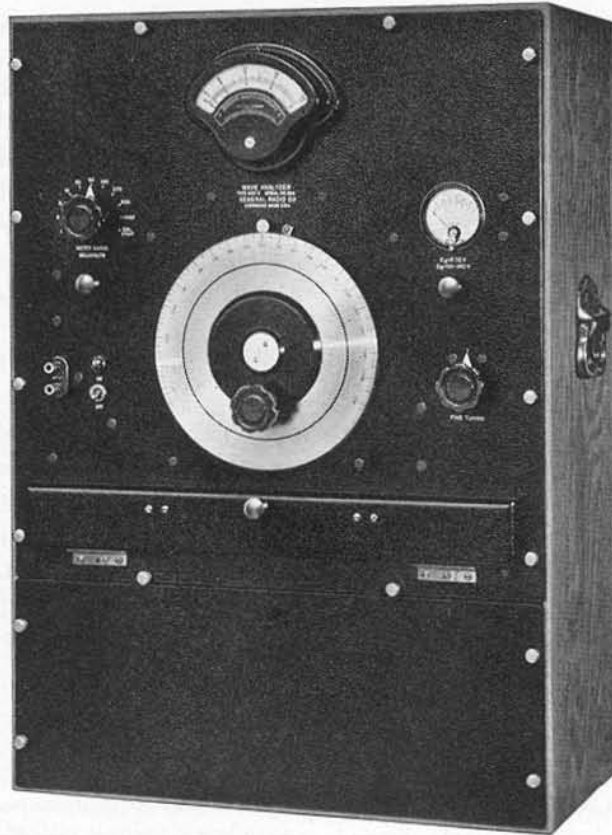

The TYPE 636-A Wave Analyzer is a superheterodyne vacuum-tube voltmeter with a very sharply tuned intermediate-frequency amplifier which makes use of two quartz-crystal filters. The range of alternating-current voltages that may be measured with the analyzer is from 200 microvolts to 200 volts.

Functionally, the instrument consists of two parts. The first is a voltmeter of adjustable sensitivity which responds to a single frequency only, and the second is a means of placing this single frequency at any point in the audio-frequency spectrum that is desired.

With the TYPE 636-A Wave Analyzer a complex waveform may be explored by adjusting the voltmeter to respond to all audio frequencies in succession and observing the voltage of each particular frequency that is present in the wave.

The operation of the device to obtain this information is extremely simple. It consists of rotating the large dial, which controls the response frequency of the voltmeter, slowly through its range, and observing each deflection of the voltmeter which occurs.

The most serious problem in the design of this type of instrument is to secure a sufficiently sharp filtering action so that the voltmeter will respond only to a very narrow band of frequencies. This has been accomplished in the TYPE 636-A Wave Analyzer by the use of a two-stage mechanical filter using quartz bars tuned to 50 kc. The use of the fixed-frequency mechanical filter results in avoidance of the circuit complications of variable-frequency filters and in a great increase in filter selectivity. In order to vary the response frequency of the analyzer while making use of a fixed-frequency filter a heterodyne method is used. The adjustable element in the system is the frequency of the heterodyning oscillator which is controlled by the large dial.

The output of the local oscillator and the whole of the complex waveform to be examined are fed to a balanced modulator where their combination produces both the sum and difference frequencies, or side bands, in the output. The original of the complex waveform is not passed by the modulator intermediate-frequency output transformer, and the local oscillator carrier frequency is suppressed in the output because of the two-tube balanced modulator employed.

The 50-kilocycle component of the upper side band, proportional to the voltage of that frequency present in the original wave to which the main dial is set, is selected and amplified by the intermediate stages. The adjustable gain control of the amplifier gives the many values listed below for full-scale deflections of the output meter. The standards for the voltage and frequency calibration are self-contained within the instrument.

The input impedance of the analyzer is normally 100,000 ohms. Under these conditions the multiplier range is such as to produce full-scale readings on the meter from 0.001 volt to 2 volts. An external 10-megohm multiplier is supplied which alters this range to from 0.1 volt to 200 volts. Since the meter can be used at one-tenth full scale, the total voltage range of the instrument is 0.2 millivolt to 200 volts.

The analyzer is not only useful for the measurement of harmonic distortion, but also for the study of non-multiple voltages in a complex waveform. Examples of this type of work include hum measurements in radio-receiver outputs and induction studies on telephone lines.

## SPECIFICATIONS

**Frequency Range:** 20 to 16,000 cycles.

**Selectivity:** Extreme selectivity permits discrimination of voltages differing by only a few cycles. The response is down 6 db at 2 cycles, 40 db at 30 cycles, and 60 db at 90 cycles from the peak. The selectivity is constant throughout the operating frequency range.

**Voltage Range:** 0.2 millivolt to 200 volts. The meter in conjunction with its multiplier has a full-scale range of 0.001, 0.002, 0.005, 0.010, 0.020, 0.050, 0.1, 0.2, 0.5, 1, and 2 volts. An external 100 to 1 multiplier is provided to increase the input impedance and to extend the range to 200 volts. Range with multiplier, 0.02 volt to 200 volts.

**Voltage Accuracy:** Within 5% on all ranges except on the 1-mv and 2-mv (full-scale) settings of the multiplier switch where the accuracy is within 10%. Spurious voltages from higher order modulation products introduced by the detector are suppressed by at least 70 db.

**Input Impedance:** 100,000 ohms; 10 megohms with the external multiplier. The 100 to 1 external multiplier is well shielded and has such a high input im-

pedance that the analyzer may be connected almost anywhere in a circuit without using series condensers or taking any other precautions usually necessary with harmonic analyzers.

**Accuracy of Calibration:** The frequency scale of the main tuning control is individually engraved and is approximately logarithmic over its full spread of almost 18 inches. For one year from the date of purchase, the calibration can be relied upon to within 2% when the analyzer has been carefully set to zero.

**Tubes Required:** Three 41-type, two 78-type, and one 37-type tubes, supplied with the instrument.

**Power Supply:** The filament supply is obtained from a 6-volt storage battery by means of cable provided. The plate supply is obtained from three 45-volt Eveready No. 872 batteries or equivalent, space for which is provided in the lower compartment of the instrument. Batteries are not included in the price of the instrument.

**Dimensions:** (Height) 27 $\frac{1}{4}$  x (width) 21 x (depth) 12 $\frac{1}{2}$  inches, over-all.

**Net Weight:** 68 $\frac{1}{2}$  pounds.

Type	Code Word	Price
636-A	ABOVE	\$490.00*

\*With tubes and multiplier, but without batteries.

PATENT NOTICE. See Notes 1, 3, 19, page v.

## CLASS 730-A TRANSMISSION MONITORING ASSEMBLY

TYPE 731-A  
MODULATION MONITOR

TYPE 732-A  
DISTORTION AND  
NOISE METER

TYPE 733-A  
OSCILLATOR



In order to maintain a broadcast transmitter at a high level of efficiency without seriously impairing the output quality, it is necessary that frequent checks be made of the transmitter performance. A transmitter operating at a modulation percentage appreciably below its maximum capability is not getting its maximum coverage. On the other hand, too high a percentage results in serious distortion. Only by the measurement of such quantities as percentage modulation, percentage distortion, over-modulation peaks, carrier noise level, etc., can the optimum conditions of operation be determined. To enable these measurements to be made rapidly and accurately is one of the functions of the Class 730-A Transmission Monitoring Assembly. In addition, the transmission can be continuously monitored with a visual indication of deviations from normal performance.

In these instruments, the simplicity of operation and direct-reading features essential for monitoring have been combined with the accuracy of a laboratory measurement.

The assembly consists of three separate units, TYPE 731-A Modulation Monitor, TYPE 732-A Distortion and Noise Meter, and TYPE 733-A Oscillator, each of which is described on the following pages. All units are a-c operated and designed for relay-rack mounting. The TYPE 731-A Modulation Monitor is approved by the Federal Communications Commission (Approval No. 1551).

The following measurements can be made:

1. Percentage modulation on both positive and negative peaks.
2. Program monitoring with high-speed volume indicator meter.
3. Carrier shift upon the application of modulation.
4. Carrier noise and hum level.
5. Combined audio-frequency harmonic distortion of modulation envelope.
6. Modulation peaks exceeding a predetermined, desired degree of modulation (i.e., over-modulation indicator).

7. Combined audio-frequency harmonic distortion present in speech-input amplifier and other station equipment.

8. Noise and hum level of audio amplifiers and other station equipment, including wire lines to remote pickup points and to transmitter.

If a variable-frequency audio oscillator is available, it is also possible to measure:

9. Transmitter audio-frequency response.

10. Audio amplifier and equipment frequency response.

11. Wire line frequency response.

The quantities measured are read directly from the instrument, and no calculations whatsoever are necessary. Neither is it necessary to make any difficult and critical adjustments or balances.

	<i>Code Word</i>	<i>Price</i>
<b>Class 730-A Transmission Monitoring Assembly</b> . . . . .	EXILE	<b>\$462.00*</b>

\*Price does not include relay rack.

PATENT NOTICE. See Notes 1, 9, 21, 22, page v.

## TYPE 731-A MODULATION MONITOR

The modulation monitor is one of the most important test instruments in the broadcasting station, since a continuous indication of the percentage modulation indicates immediately any deviation from normal performance.

TYPE 731-A Modulation Monitor consists of three essential elements: (1) a linear diode rectifier which gives an instantaneous output voltage proportional to the carrier envelope, (2) a peak voltmeter which gives a continuous indication of the peak modulation, and (3) a trigger circuit which flashes a light whenever the modulation momentarily exceeds any value which has been previously set by the operator.

In the output of the linear rectifier is a d-c meter which indicates the carrier level at which the instrument is operating and also shows any carrier shift during modulation, a condition which results from unequal positive and negative peaks.

The meter which reads modulation percentage has a high speed movement. It is used in conjunction with electrical delay circuits to give a rapid upswing and a slower return. This type of movement is extremely easy to follow with the eye and is the most satisfactory method of monitoring level thus far devised.

The flashing lamp is extremely useful as a monitoring device. It is set to flash with moderate frequency when the transmitter is operating normally. If, without a change in program, the flashing rate changes markedly, the operator is made aware that something is wrong.

The TYPE 731-A Modulation Monitor meets all the requirements for modulation monitors of Rule 139 Amended of the Federal Communications Commission. It has been approved by the Commission and assigned Approval No. 1551.

### SPECIFICATIONS

**Range:** Modulation percentage, 0 to 110% indicated by meter on positive or negative peaks; flashing incandescent lamp adjustment, 0 to 100% on negative peaks.

**Carrier Frequency Range:** The monitor will operate at any carrier frequency between 200 and 30,000 kc.

Since the input circuit is a condenser voltage divider, a slight alteration of the input circuit may be necessary at the higher frequencies to prevent the excessive absorption of power from the transmitter.

**Accuracy:** The over-all accuracy of measurement is  $\pm 2\%$  of the modulation percentage at 0% and 100%.



At 50% modulation the possible error rises to a maximum of 4% of the indicated percentage.

**Modulation Frequency Range:** The frequency response is flat within 0.5 db between 40 and 15,000 cycles.

**Power Supply:** 115 volts, 50 to 60 cycles.

**Meters:** Rectified carrier meter and high speed per cent modulation meter are provided. The latter has a decibel scale as well, which is useful when adjusting transmitter input. It can also be used for taking over-all fidelity characteristics.

**Controls:** A control is included for adjusting the amplitude of the carrier. A switch is provided for measuring the positive or the negative peaks, as desired. A NOMINAL MODULATION PEAKS dial, calibrated, and continuously variable from 0 to 100%, is provided. An ON-OFF switch with pilot lamp controls the power input.

**Vacuum Tubes:** The following tubes are used: two 1-V, one 6C6, one 75, one 885, and one 84. All are supplied with the instrument.

**Lamp:** The OVER-MODULATION lamp will flash at the instant when the modulation exceeds the value to

which the NOMINAL MODULATION PEAKS dial is set, and will remain lighted so long as this condition persists. An incandescent lamp is used, giving a brilliant light.

**Shielding:** The modulation monitor is well shielded so that it may be operated in radio-frequency fields encountered in the operating room.

**Terminals:** A pair of binding posts at the rear is provided for the radio-frequency input. Terminals are provided on the multipoint connector at the rear for connecting an additional remote "over-modulation" indicator lamp, or a remote high-speed modulation meter. Provision is also made for connecting a peak counter or recorder.

**Other Accessories Supplied:** Spare pilot lamps and fuses, multipoint connector, and cord and plug assembly for the a-c line connection.

**Mounting:** The instrument is relay-rack mounted. The panel is aluminum with the standard General Radio black lacquer finish.

**Dimensions:** Panel, (length) 19 x (height) 8 $\frac{3}{4}$  inches; depth behind panel, 12 inches.

**Net Weight:** 30 pounds.

<i>Type</i>	<i>Code Word</i>	<i>Price</i>
731-A	EXIST	\$195.00

PATENT NOTICE. See Notes 9, 21, 22, page v.

## TYPE 732-A DISTORTION AND NOISE METER

Audio-frequency distortion and noise level cannot be measured while the program is on, but through the use of the TYPE 732-A Distortion and Noise Meter these qualities can be measured so rapidly that frequent checks are possible without interfering with station operation.

This instrument consists of a linear rectifier, a filter, an amplifier, and a vacuum-tube voltmeter. The meter reads distortion directly in per cent and reads carrier noise or hum level directly in decibels with respect to normal modulating input to the transmitter.

Provision has been made, by the inclusion of front-panel jacks, for using the equipment with audio-frequency inputs in the measurement of distortion and noise in supplementary pickup lines and speech amplifiers in order that they may be brought to the same high standard of performance established in the transmitter itself.

The output of the linear rectifier is also available from panel jacks so that a wave analyzer may be used to analyze the waveforms of the carrier envelope over the complete audio-frequency range. A TYPE 636-A Wave Analyzer is recommended for this purpose.

A 400-cycle test signal of good waveform is required for use with the distortion and noise meter. The TYPE 733-A Oscillator described on the next page has been designed for this purpose.

## SPECIFICATIONS

**Distortion Range:** Distortion is read directly from a large meter. Full-scale values of 30%, 10%, 3%, and 1% are provided, and are selected by a multiplier switch. The range for carrier noise measurement is from 30 to 70 db below 100% modulation or 65 db below an audio-frequency signal of zero level.

**Audio-Frequency Range:** 380 to 420 cycles for distortion measurements; 30 to 10,000 cycles for noise or hum measurement.

**Carrier Frequency Range:** 200 kc to 30,000 kc.

**Accuracy:** The over-all accuracy of the measurements is better than  $\pm 5\%$  of the indicated percentage distortion.

**Meter:** A Weston Model 643 Meter, calibrated directly in per cent distortion and decibels noise level, is provided. Zero adjustment of the meter is made by a knob projecting from the meter face.

**Controls:** A carrier input control is provided so that the radio-frequency input may be adjusted. This adjustment is not critical and it is necessary only to set the carrier roughly to the value required to

produce full-scale deflection on the meter. An amplifier gain control and an ON-OFF switch with pilot lamp are also provided.

**Vacuum Tubes:** One 37, two 6C6, one 1-V, and one 84 are supplied.

**Other Accessories Supplied:** Spare fuses and pilot lamps.

**Terminals:** In addition to the radio-frequency input binding posts at the rear, two normal-through Western Electric output double jacks are provided on the panel, one at high impedance for the modulated envelope from the rectifier, and one at 500 ohms for the input to the distortion and noise-meter amplifier for use in audio-frequency testing.

**Power Supply:** 115 volts, 60 cycles, ac.

**Mounting:** The instrument is relay-rack mounted. The panel is aluminum with the standard General Radio black crackle lacquer finish.

**Dimensions:** Panel, 19 x 8 $\frac{3}{4}$  inches; depth behind panel, 12 inches.

**Net Weight:** 40 pounds.

Type	Description	Code Word	Price
732-A	Distortion and Noise Meter . . . . .	EXPEL	\$205.00

PATENT NOTICE. See Note 1, page v.

## TYPE 733-A OSCILLATOR

For distortion measurements an audio oscillator of extremely low harmonic content is required in order that the residual distortion be negligible in comparison with the small amount introduced by the equipment under test. When the TYPE 732-A Distortion and Noise Meter is used, an oscillator of fixed frequency between 380 and 420 cycles is required. The TYPE 733-A Oscillator is designed for this purpose.

### SPECIFICATIONS

**Frequency:** 400 cycles  $\pm 2\%$ . The frequency of the oscillator does not change by more than 1% because of heat dissipation in the unit or changes in ambient temperature. The design of the filter of the TYPE 732-A Distortion and Noise Meter with which this oscillator is used is such that much wider changes than this would have entirely negligible effect.

**Output Power:** 30 milliwatts (+7.5 decibels).

**Internal Output Impedance:** 50, 500, or 5000 ohms. This is obtained by changing a connection between the output terminals and the filter. These values of output impedance enable a wide range of impedances to be connected to the oscillator without large mismatch loss.

**Waveform:** 0.1% to 0.2% distortion, depending

upon load. The distortion is less than 0.1% when the load is 5 milliwatts and is 0.05% at no load.

**Controls:** There is an output volume control and an ON-OFF switch.

**Tubes:** One 76 and one 25Z5 are supplied.

**Terminals:** A Western Electric output double jack is provided on the panel and binding posts at the rear.

**Power Supply:** 115 volts, 60 cycles, ac.

**Mounting:** The instrument is relay-rack mounted. The panel is aluminum with the standard General Radio black crackle lacquer finish.

**Dimensions:** 19 x 5 $\frac{1}{4}$  x 8 inches deep.

**Net Weight:** 18 pounds.

Type	Description	Code Word	Price
733-A	Oscillator . . . . .	EXTOL	\$62.00

PATENT NOTICE. See Note 1, page v.

TYPE 530 BAND-PASS FILTER

This filter was designed for use with 400-cycle oscillators to purify the voltage for use in distortion measurements. It is useful in any other cases where an extremely pure 400-cycle voltage is desired. The use of one of these filters reduces the harmonic content by at least 50 decibels. They may be used with a fundamental frequency of from 375 to 425 cycles. Sufficient attenuation is provided at the low-frequency end to remove any power-supply hum voltage which may be present. The two types differ only in characteristic impedance. These filters are not carried in stock but are supplied on order.



Inasmuch as the type of filter section employed is unbalanced to ground, this band-pass filter may not be used in balanced-circuit inputs to the apparatus under test. For balanced-line inputs the use of a TYPE 585-R Transformer, described on page 144, between the filter section and the apparatus input is recommended. This transformer is designed for the interconnection of balanced and unbalanced lines and will not introduce harmonics into a 400-cycle test signal of moderate amplitude.

A 400-cycle, vacuum tube, a-c operated oscillator with an output waveform of purity equal to that obtained from other sources through a TYPE 530 Band-Pass Filter is a component part of the CLASS 730-A Transmission Monitoring Assembly described on page 109. This 400-cycle TYPE 731-A Oscillator is separately available in rack-mounting form.

SPECIFICATIONS

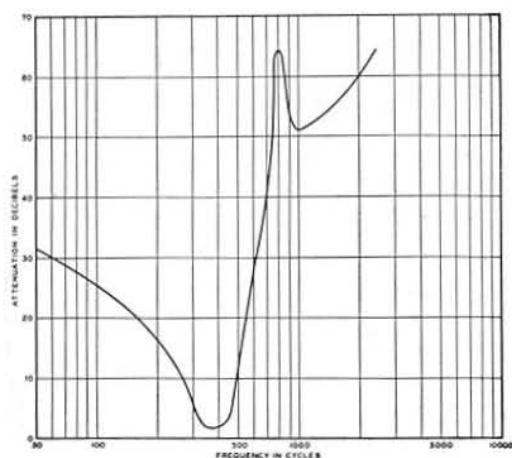

**Attenuation Characteristic:** See accompanying curve. A peak of maximum attenuation is set for rejection of the 800-cycle second harmonic.

**Impedance:** Designs are on file for a filter of 600-ohm characteristic impedance for line use and for a 6000-ohm filter for use, with a blocking condenser, directly on the output of an oscillator or an amplifier stage. Filters ordered for other impedances are obtainable at a slight increase in cost.

**Mounting:** Filters are mounted in standard drawn steel, wax-filled Model D cases.

**Dimensions:** Case, (width)  $5\frac{3}{4}$  x (height)  $5\frac{1}{2}$  x (depth)  $5\frac{1}{2}$  inches, over-all. See also dimensioned drawing, page 157.

**Net Weight:** 8 pounds.

Type	Impedance	Pass Band	Code Word	Price
*530-A	600 ohms	375-425 cycles	FOCAL	\$30.00
*530-C	6000 ohms	375-425 cycles	FURRY	30.00

\*Built to order—not carried in stock.  
PATENT NOTICE. See Note 1, page v.

TYPE 830 WAVE FILTERS

TYPE 830 Wave Filters are built in low-pass, high-pass, and band-pass models. The high- and low-pass types are compact two-section filters having particularly good characteristics. The sections co-operate to give both a sharp cut-off and high discrimination against frequencies outside the pass band. Approximate attenuation curves are shown below. It will be seen that the insertion loss at the cut-off frequency is less than 3 decibels and that a discrimination of at least 40 decibels is maintained for all frequencies greater than 1.5 times the cut-off for the low-pass types or less than two-thirds of the cut-off for the high-pass types.

The 500-c.p.s. high-pass and 1000 c.p.s. low-pass types can be used in tandem to provide a band-pass filter covering one octave. The attenuation curve of this combination is also shown.

The band-pass model, TYPE 830-R, is sharply tuned to pass 1000 c.p.s. and discriminate against other frequencies, the design being such that a maximum of attenuation is provided for the second harmonic at 2000 c.p.s. The input and output coils of this unit are tapped so that the filter can be used with high or low terminating impedances, or to replace the combination of a filter and transformer to work between different impedances. It is particularly suited to operate between the high-impedance output of the TYPE 814-A Amplifier and a copper-oxide meter to provide a visual balance indicator for bridge measurements at 1000 c.p.s.

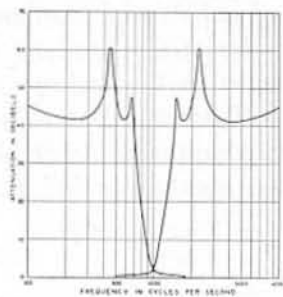

1000-cycle H-P and L-P

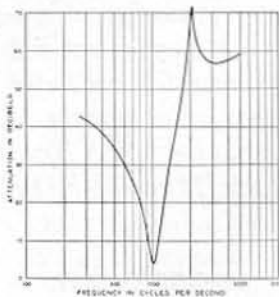

TYPE 830-R

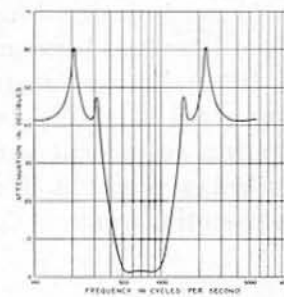

500-cycle H-P and 1000-cycle L-P

SPECIFICATIONS

**Mounting:** All models except TYPE 830-B are mounted in Model C cases, dimensions for which are given on page 141. TYPE 830-B is mounted in a Model D case.

**Terminals:** TYPES 830-A to 830-H inclusive are provided with both soldering lugs and jack-top binding posts. TYPE 830-R has soldering lugs only.

**Net Weight:** TYPE 830-B, 7½ pounds; all others, 3½ pounds.

Type	Cut-Off Frequency	Impedance		Code Word	Price
*830-A	500 cycles	500 Ω	Low-Pass	FILTERGOAT	\$18.50
*830-B	500 cycles	500 Ω	High-Pass	FILTERGIRL	21.50
*830-C	500 cycles	5000 Ω	Low-Pass	FILTERSHOE	18.50
*830-D	500 cycles	5000 Ω	High-Pass	FILTERSEAT	18.50
*830-E	1000 cycles	500 Ω	Low-Pass	FILTERTOAD	18.50
*830-F	1000 cycles	500 Ω	High-Pass	FILTERMUSH	18.50
*830-G	1000 cycles	5000 Ω	Low-Pass	FILTERSIGN	18.50
*830-H	1000 cycles	5000 Ω	High-Pass	FILTERPIPE	18.50
830-R	1000 cycles	{ 5000, 500 50,000, 5000, 50, 50 }	Band-Pass	FILTERROTE	19.50

\*PATENT NOTICE. See Note 1, page v.



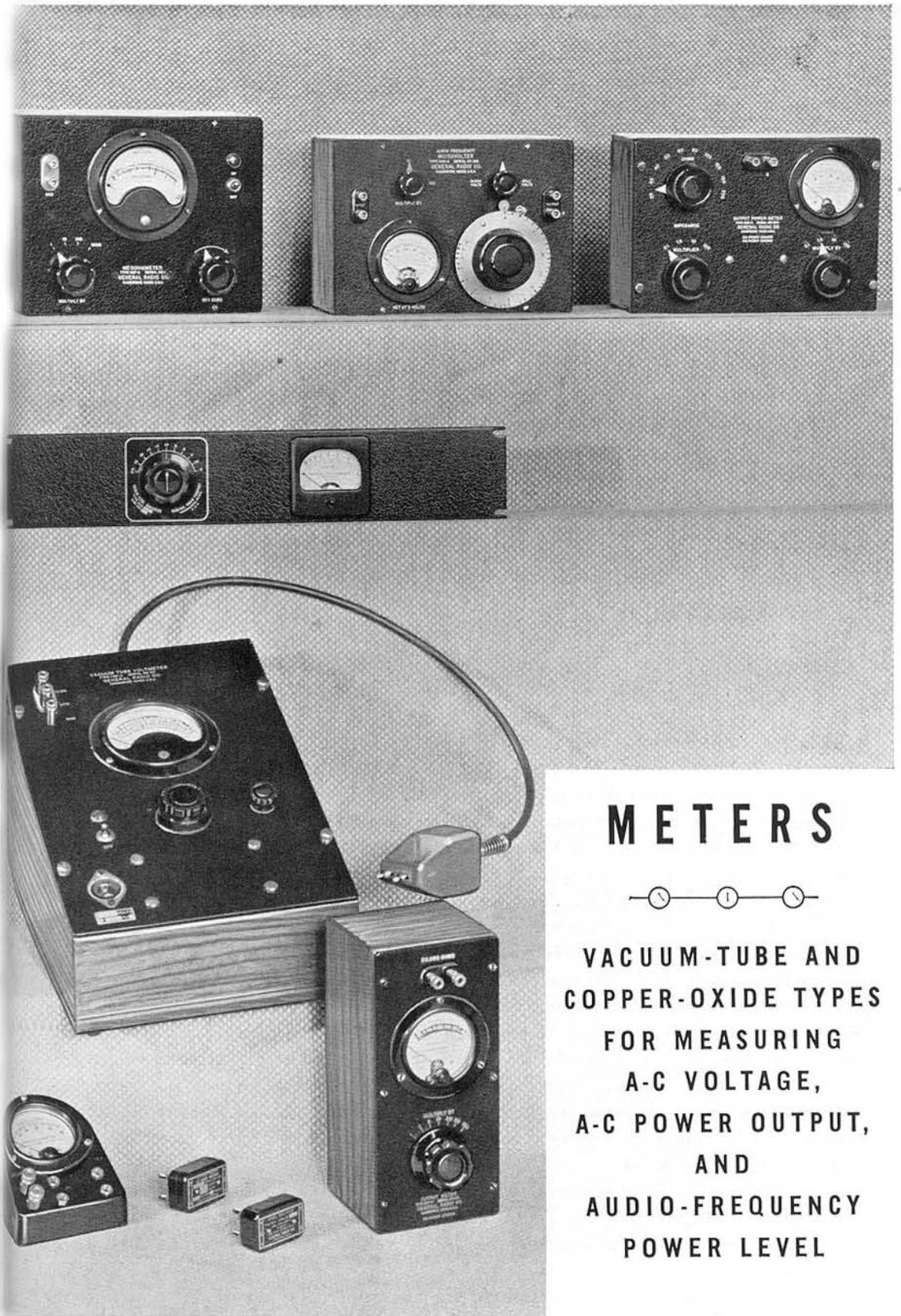

## METERS

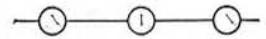

VACUUM-TUBE AND  
COPPER-OXIDE TYPES  
FOR MEASURING  
A-C VOLTAGE,  
A-C POWER OUTPUT,  
AND  
AUDIO-FREQUENCY  
POWER LEVEL

## TYPE 726-A VACUUM-TUBE VOLTMETER



This is a multiple-range instrument designed to permit the measurement of a wide range, 0.1 to 150 volts, without employing external multipliers. A five-position switch changes the range and also corrects the zero setting, so that in making measurements it is merely necessary to connect the unknown voltage to the terminals of the instrument and vary the switch until the reading obtained is on scale. Over-voltage cannot damage the meter. Since the scale is essentially linear, the ranges provided make it possible to read all except the lowest voltages well up on the scale, resulting in a considerable increase in accuracy.

To increase the accuracy of measurement at high radio frequencies, the entire a-c measuring circuit is mounted in a probe at the end of a five-foot cable, which permits the measurement of voltages directly at the source. Since the cable and the indicating circuit carry only direct current, all effects of long leads are eliminated and an excellent frequency characteristic is made possible. For measurement at extremely high frequencies, the probe terminals can be removed, still further shortening the leads.

For measurements at lower frequencies, where the effect of the leads is not important, the probe and cable may be placed inside the instrument and connections made to terminals on the panel.

A-c operation has been achieved with the stability of a d-c instrument by means of a built-in voltage regulator. There is no appreciable shift of the zero after a brief warming-up period and variations in the supply voltage do not cause fluctuations in the reading.

The electrical circuits of the instrument are such that the calibration is substantially independent of tube characteristics. For this reason aging of the tubes results in a negligible error, and replacement of tubes affects the calibration only slightly. Tubes are operated under conditions which give exceptionally long life.

## SPECIFICATIONS

**Range:** 0.1 to 150 volts in five ranges (1.5-5-15-50-150 volts).

**Accuracy:**  $\pm 2\%$  of full scale at all five ranges, on sinusoidal voltages.

**Waveform Error:** The instrument is essentially a peak voltmeter calibrated to read r-m-s values of a sine wave, or 0.707 of the peak value of a complex wave. On distorted waveforms the percentage deviation of the reading from the r-m-s value may be as large as the percentage of harmonics present.

**Frequency Error:** Less than 1% between 20 cycles and 50 megacycles. At 100 megacycles, the voltage indicated is about 3% larger than the voltage across the probe terminals.

**Input Impedance:** About 5 megohms at low audio frequencies. Since the capacitance between input terminals at the probe is 8  $\mu\text{f}$ , the input impedance will be lower at higher frequencies. The resonant

frequency of the input circuit is about 500 megacycles.

**Power Supply:** 100 to 130 volts, ac, 60 or 42 cycles and 200 to 260 volts, 50 cycles (see price list). The instrument incorporates a voltage regulator to compensate for supply variations over this voltage range. The power drain is less than 20 watts.

**Tubes:** One 955-type, one 75-type, and one 1-V rectifier-type, supplied with the instrument.

**Accessories:** A seven-foot attachment cord, a pilot lamp, and the three tubes are supplied with the instrument.

**Mounting:** Black crackle-finish aluminum panel mounted in a shielded walnut cabinet.

**Dimensions:** (Width)  $9\frac{1}{2}$  x (depth) 14 x (height)  $8\frac{1}{2}$  inches, over-all.

**Net Weight:**  $17\frac{1}{2}$  pounds.

Type	Power Supply		Code Word	Price
	Frequency	Voltage		
726-A	60 cycles	100 to 130	ALLOT	\$165.00
726-A	50 cycles	200 to 260	ALTER	165.00
726-A	42 cycles	100 to 130	AMASS	165.00

## TYPE 546-A MICROVOLTER

The measurement of small a-c voltages presents a problem of some difficulty in consequence of the absence of instruments of sufficient sensitivity for direct measurements. This has resulted in the adoption of a substitution method with which we are more familiar in direct-current measurements. A voltage of sufficient magnitude to be measured accurately on available instruments is impressed upon an accurate calibrated resistance network which can then be adjusted to vary the output voltage to equality with the unknown for which it has been substituted.

In the TYPE 546-A Microvolter an instrument has been designed incorporating these elements in a form suitable for use over the audio-frequency range.

The attenuator, which is the essential element of the design, consists of a sectionalized network of constant output impedance. The output ratio is controlled by switches for large steps and by a continuously adjustable dial for small steps. The latter consists of a slide-wire covering a range of two decades and having an exponential scale.

The instrument is completed by a voltmeter on which the input voltage is measured and a coupling transformer at the input end.

Although the transformer has been designed to have a reasonably flat characteristic for audio frequencies, it is evident, since it precedes the voltmeter, that transformer losses do not enter into the measurements in any way. For convenience the switching arrangement provides for maintaining constant the impedance of the attenuator as



seen from the generator side. This is not essential from the standpoint of voltage computations, but it is convenient in avoiding the necessity of readjusting the input power as the attenuation is altered.

This new unit has many applications in measurements involving low voltages. It is useful for conveniently adjusting the output of vacuum-tube oscillators or other sources of alternating current. Used with the TYPE 483-C Output Meter or a TYPE 583-A Output Power Meter it provides all the equipment necessary for measuring gain characteristics.

SPECIFICATIONS

**Output Voltage Range:** From 1 volt to 1 microvolt for a "reference voltage" of 2 volts.

**Accuracy:** For output voltage ratios the error is less than 2% above 100-microvolt settings. The error is somewhat greater for smaller output voltages. In absolute measurements the characteristics of the copper-oxide voltmeter must be considered. For output voltages greater than 100 microvolts the error is less than 10%, 12.5% or 17% at 1000, 5000, or 10,000 cycles, respectively.

**Power Source:** An audio-frequency source having an output control and capable of maintaining approximately 9 volts across 7000 ohms is required. The use of other than the 2-volt standard reference level

produces proportional deviations in output.

**Input Transformer:** The transformer is designed to have a reasonably flat characteristic over the audio-frequency range, but, since it precedes the voltmeter, its losses do not enter into the measurements.

**Output Impedance:** The internal output impedance of 200 ohms must be taken into account when supplying voltage to low-impedance loads.

**Mounting:** The instrument is mounted on an aluminum panel in a shielded walnut cabinet.

**Dimensions:** (Length) 10 x (width) 7¼ x (height) 6⅛ inches, over-all.

**Net Weight:** 8⅜ pounds.

Type	Code Word	Price
546-A	CROWN	\$80.00



## TYPE 487-A MEGOHM METER

AN OHMMETER  
FOR THE  
MEGOHM RANGE  
OF RESISTANCE



The TYPE 487-A Megohm meter indicates directly, with the simplicity of operation of an ordinary ohmmeter, resistance values from 20,000 ohms to 50,000 megohms. This result is achieved by employing a vacuum-tube voltmeter as the indicator in a conventional ohmmeter circuit. The instrument is completely a-c operated and takes only 10 watts of power from the a-c mains.

The megohm meter can be used for general high resistance testing, as, for instance, the measurement of resistors and of leakage resistance and the location of defective insulation. As with ohmmeters, the voltage applied to the unknown varies with the indication, and is between 50 and 100 volts over the greater portion of its range. Consequently, this instrument is not suitable for the location of breakdowns which occur only at higher voltages.

In measuring large condensers with low leakage, the time constant results in equilibrium being reached very slowly. For example, a condenser of 1  $\mu$ f capacitance, having a leakage resistance of 1000 megohms, could be shown in a few seconds to have a resistance greater than 500 megohms, but perhaps a minute would be required to get the resistance within 10 per cent. For many applications in general testing, however, the limitations regarding the applied voltage and the time constant are more than offset by the rapidity of the measurement and the ease of operation.

Where a higher test voltage or a lower time constant is required, the TYPE 544-A Megohm Meter (see page 84) is recommended.

## SPECIFICATIONS

**Range:** 20,000 ohms to 50,000 megohms in four overlapping ranges.

**Operation:** The instrument is direct reading, requiring no balancing adjustment.

**Scale:** Standard ohmmeter calibration with center scale values of 1, 10, 100 and 1000 megohms. Length of scale  $3\frac{11}{32}$  inches, center decade  $1\frac{3}{4}$  inches.

**Accuracy:** Within 5% from 200,000 ohms to 5000 megohms, decreasing for higher or lower values.

**Tubes:** The necessary tubes, 1 type 1-V and 1 type 85, are supplied.

**Power Supply:** 115 volts, 42-60 cycles ac. The power requirement is ten watts.

**Accessories:** A 7-foot connecting cord and spare fuses are supplied.

**Mounting:** The instrument is supplied in a hand-rubbed walnut case and is mounted on an engraved black crackle-finish aluminum panel.

**Dimensions:** (Width) 10 x (height) 8 x (depth)  $5\frac{1}{2}$  inches.

**Net Weight:**  $9\frac{1}{4}$  pounds.

Type	Code Word	Price
487-A	ONION	\$95.00

TYPE 586

POWER-LEVEL INDICATOR

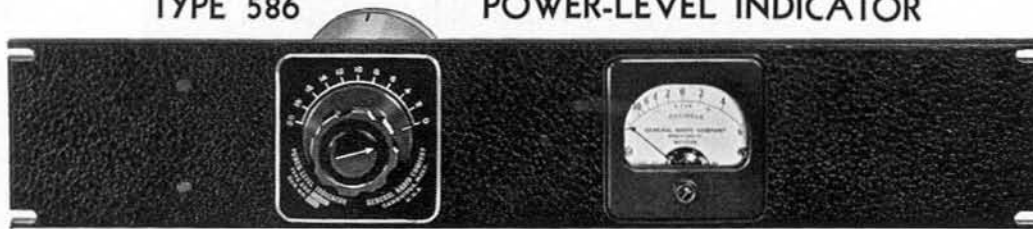

This instrument utilizes the copper-oxide rectifier-type indicating meter, with a scale calibrated in decibels. It is provided with an adjustable L-type attenuator which is inserted between the line and the indicating voltmeter. The attenuator acts as a multiplier to increase the measuring range of the instrument while maintaining constant the input resistance of the power-level indicator. The assembly is portable, compact, rugged, accurate, low in price, and requires no batteries.

The moving element of the meter is of the high-speed type for the models -DM and -DR, and is normal speed for the more sensitive models -EM and -ER. Because of the meter dynamics a high-speed movement cannot be achieved with the ultra-sensitive meters of high impedance.

The standard panel finish is black crackle lacquer. In order to match the finish of other studio or transmitter equipment, panels for the rack-mounting models are also available to order, finished in either Western Electric or RCA gray, or RCA flat black at an additional price. (See specifications.)

SPECIFICATIONS

**Power-Level Range:** See price list. All ratings are for a zero level of 6 milliwatts in a 500-ohm line.

**Internal Input Impedance:** 5000 ohms resistive. There is, therefore, an insertion loss of 0.8 decibel. Essentially, no distortion is introduced into the line.

**Frequency Characteristics:** There is no appreciable error for frequencies up to 10,000 cycles.

**Scale Reading:** For TYPE 586-DM and TYPE 586-DR zero level is at mid scale. The meter is graduated in 2-decibel steps between -10 and +6 decibels.

For TYPE 586-EM and TYPE 586-ER -10 decibel level occurs at mid scale. Mid scale is, however, marked zero. The multiplier switch is arranged so that at maximum sensitivity its reading combined with that of the meter is -10 decibels.

The multiplier attenuator of all models is adjustable in 2-decibel steps over a total range of 20 decibels.

**Indicating Element:** A copper-oxide-rectifier voltmeter calibrated to read power level in decibels.

High-speed movement for models -DM and -DR; normal speed for models -EM and -ER.

**Accuracy:** The average error is from 0.1 decibel to 0.2 decibel. Near the lowest reading of the meter the error may be as much as 0.5 decibel.

**Correction Chart:** A chart is supplied showing the correction to be applied when the meter is used across impedances other than 500 ohms.

**Mounting:** The TYPE 586-DM and TYPE 586-EM are mounted on an aluminum panel in a polished walnut cabinet. TYPE 586-DR and TYPE 586-ER are designed for mounting on a standard 19-inch relay rack. All switches are back-of-panel mounted.

**Dimensions:** For the cabinet models, (length) 9 $\frac{3}{8}$  x (width) 4 $\frac{1}{4}$  x (depth) 4 $\frac{1}{4}$  inches, over-all. For the relay-rack models, (length) 19 x (width) 3 $\frac{1}{2}$  x (depth) 3 $\frac{1}{4}$  inches, over-all.

**Net Weight:** 3 $\frac{7}{8}$  pounds for cabinet models, 3 $\frac{1}{4}$  pounds for relay-rack models.

Type	Power-Level Range	Mounting	Code Word	Price
586-DM	-10 to +26 decibels	Cabinet Model	HABIT	\$55.00
586-DR	-10 to +26 decibels	Relay-Rack Model	HANDY	55.00*
586-EM	-20 to +16 decibels	Cabinet Model	HONEY	60.00
586-ER	-20 to +16 decibels	Relay-Rack Model	HONOR	60.00*
586-P6	High-speed meter for Type 586-DM or -DR		OURMETBELL	25.00
586-P5	Normal-speed meter for Type 586-DM or -DR		OURMETFOOT	20.00
586-Q1	Normal-speed meter for Type 586-EM or -ER		OURMETPIPE	30.00

\*Panel finish to match Western Electric or RCA gray, or RCA flat black, \$4.00 additional. PATENT NOTICE. See Note 6, page v.

## TYPE 583-A OUTPUT POWER METER

FOR MEASUREMENTS  
OF  
POWER OUTPUT  
AND  
INTERNAL IMPEDANCE

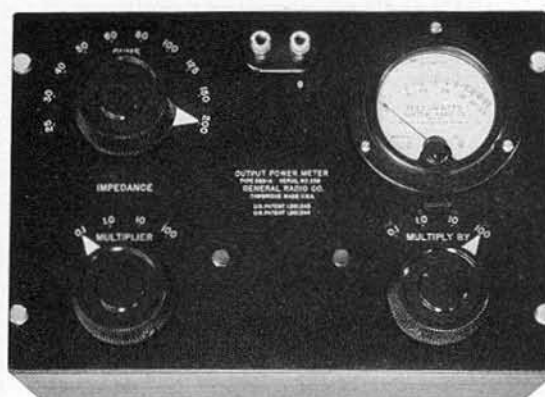

This unusual instrument reads directly the amount of audio-frequency power that any given source is capable of delivering. It can be considered to be an adjustable load impedance across which is connected a voltmeter that is calibrated directly in watts lost in the load. Adjustments are provided for an impedance range from 2.5 to 20,000 ohms and for a power range from 0.1 to 5000 milliwatts. In addition to the power scale (milliwatts) on the meter, there is also an auxiliary scale giving the power level in decibels for a reference level of 1 milliwatt.

Many uses for such an instrument are possible. For instance:

(a) The power that an audio-frequency generator will deliver to a load of a given impedance can be found immediately without calculation.

(b) The effect of load impedance on power delivered can be measured.

(c) An important application is in the testing of radio receivers. The meter will serve for the standard selectivity, sensitivity, band-width, and fidelity tests. The auxiliary decibel scale is for this use.

(d) The characteristic impedance of telephone lines, phonograph pickups, vacuum-tube oscillators, etc., can be determined by adjustment of the impedance of the power meter until a maximum reading is obtained. When this occurs, the impedance of the meter is set to the impedance of the source under measurement.

### SPECIFICATIONS

**Power Range:** 0.1 to 5000 milliwatts.

**Meter:** Calibrated from 1 to 50 milliwatts with auxiliary scale reading from 0 db to 17 db with 1 milliwatt as reference level.

**Multiplier:** Multiplies meter power scale by factors of 0.1, 1.0, 10, and 100. Also adds -10, 0, +10, and +20 db to auxiliary decibel scale.

**Frequency Characteristics:** Accuracy varies with frequency and impedance setting. Maximum error in full-scale power reading does not exceed 0.3 db

between 150 and 2500 cycles, nor does it exceed 1.5 db at 20 and 10,000 cycles. The average error is 0.3 db at 30 and 5000 cycles; and 0.6 db at 20 and 10,000 cycles.

Maximum error in impedance does not exceed 7% between 150 and 3000 cycles, nor does it exceed 50% at 20 and 10,000 cycles. The average error is 8% at 30 and 5000 cycles; and 20% at 20 and 10,000 cycles.

**Size:** (Length) 10 x (width) 7 x (height) 6 inches, over-all.

**Net Weight:** 8¼ pounds.

Type	Code Word	Price
583-A	ABUSE	\$95.00

PATENT NOTICE. See Notes 5, 6, page v.

TYPE 483-C OUTPUT METER

This is the constant-impedance volt-meter employing a copper-oxide-rectifier indicator that was introduced by the General Radio Company several years ago for measuring the performance of radio receivers. It is, of course, useful wherever audio-frequency voltages are to be measured.

Three impedance values have been selected as the ones most generally needed. Particular attention is directed to the TYPE 483-C Output Meter which has a voltage range of 0-200 volts and an internal impedance of 20,000 ohms.

SPECIFICATIONS

**Voltage Range:** 200 volts (2-volt meters with multipliers of 2, 5, 10, 20, 50, and 100).

**Impedance Characteristic:** With the multiplier set at "1" the impedance of the instrument is that of the rectifier and meter only and hence varies somewhat with applied voltage. The impedance increases approximately 30% for 0.5 volt applied. With increase in multiplier setting the impedance approaches a pure resistance of the rated value. The multiplier resistors are adjusted to within  $\pm 2\%$ .

**Accuracy of Calibration:** Because of the characteristics of the self-contained rectifier, the meters are subject to errors other than that of the d-c meter movement.

With a multiplier setting of two the error in multiplication, because of the impedance variation of the rectifier with applied voltage, is a maximum. The meter will be within 3% and 6% for 2-volt and 1-volt inputs, respectively. This network error is zero on the upper third of the scale and decreases rapidly for the small deflections as the multiplier setting is increased.

The frequency and temperature errors are con-



siderable. Over extreme ranges of temperature and frequency the combined error may be as great as 25%.

**Scale Length:** 2½ inches.

**Mounting:** The copper-oxide-rectifier voltmeter and the multiplier switch are mounted on a bakelite panel which, in turn, is mounted in a polished walnut case.

**Dimensions:** (Length) 9 x (width) 4¼ x (height) 4¾ inches, over-all.

**Net Weight:** 3 pounds.

Type	Impedance	Voltage Range	Power Range	Power for Half-Scale Deflection	Code Word	Price
483-C	20,000 ohms	0-200 volts	0-2 watts	0.05 mw	AVOID	\$54.00

PATENT NOTICE. See Note 5, page v.



THERMOCOUPLES, OXIDE RECTIFIERS

A-c measurements with d-c instruments. Bakelite cases for plug-in mounting. See descriptions, pages 134 to 137.



## TYPE 672-A POWER SUPPLY



The TYPE 672-A Power-Supply unit is designed for general laboratory use. It delivers d-c power up to 45 watts at 150 ma and 300 volts, with a no-load voltage of over 400 volts. An additional rectifier circuit supplies 2 ma dc at 100 volts. Two separate a-c supplies are also provided at 6.3 and 2.5 volts, from which a total of 45 watts may be taken.

The unit is primarily designed for vacuum-tube circuits but will be found useful in other capacities. The high-voltage input is controlled by a Variac (adjustable auto-transformer) with a control on the panel so that continuous variation of the d-c output voltage (0 to over 400 volts) is possible. Meters on the panel indicate the output voltage and current. The low-voltage dc is convenient as a grid supply, and a ground connection can be used on any of the d-c supply terminals. A calibrated potentiometer mounted on the panel controls the low-voltage supply.

Excellent regulation at any output setting is assured by the Variac control and a carefully designed filter, which also insures a very low residual hum voltage.

## SPECIFICATIONS

**Output Range:**

*High Voltage:* 150 ma at 300 volts, dc. No load voltage, over 400 volts, dc.

*Low Voltage:* 2 ma at 100 volts dc.

*A-C Voltage:* 2.5 and 6.3 volts, giving a total of 45 watts.

**Meters:** The high-voltage supply output is indicated by an ammeter and a voltmeter mounted on the panel.

**Regulation:** The regulation of the high-voltage supply corresponds to an internal output resistance of 700 ohms for direct current. The 1000-cycle internal output impedance of the high-voltage supply is equivalent to 3.9  $\mu$ f in series with 1.13 ohms. That of the low-voltage supply is equivalent to 2.12  $\mu$ f in series with 0.82 ohm.

**Supply:** The power-supply unit will operate from a 105-120 volt, 50-60 cycle, a-c line.

**Power Consumption:** With the a-c and d-c supplies operating at full load, the power consumption from the mains is about 175 watts. Under these conditions the loss in the power-supply unit is about 85 watts, including rectifier cathode power.

**Hum Voltage:** At full-load current the hum voltage of the high-voltage supply is less than 0.1% for all voltages above 150 volts. For lower voltages the per cent is slightly higher.

At full-load current the hum voltage of the low-voltage supply is less than 0.1% for all voltages. For a load current of 1 ma, the hum decreases to 0.03%.

**Tubes:** One 5Z3-type and one 80-type are supplied.

**Mounting:** The instrument is suitable for either table or relay-rack mounting.

**Dimensions:** (Length) 19 $\frac{1}{2}$  x (depth) 11 $\frac{1}{2}$  x (height) 7 $\frac{3}{8}$  inches, over-all. Panel 19 x 7 inches.

**Net Weight:** 41 pounds.

Type	Code Word	Price
672-A	AFOOT	\$130.00

PATENT NOTICE. See Note 11, page v.

## TYPE 673-A POWER SUPPLY



This is a power-supply unit for general laboratory use. It has a d-c open-circuit voltage of over 2000 volts and delivers 150 ma at 1500 volts. Provision is also made for supplying a maximum of 6.5 amperes at 10 volts ac with a 5-volt center tap.

Several distinguishing features make the TYPE 673-A Power-Supply unit a very handy piece of apparatus about the laboratory. A knob on the panel gives a continuous control of the high voltage, which is indicated by a meter on the panel. The output current is also indicated by a panel meter. Consequently, besides using the unit as a supply for, say, two 852-type tubes, it can be operated as a continuously-variable-voltage d-c supply (from below 50 to over 2000 volts). Transformer control in the high-voltage input and careful design of the filter have produced good regulation and low hum voltage. The power-supply unit is equipped with a time switch so that the a-c supply is on about 30 seconds before the d-c supply begins to operate. An auxiliary switch, for the sake of convenience and safety, is supplied to control the high voltage separately.

## SPECIFICATIONS

**Output Range:** The power supply will deliver direct current up to 150 ma at 1500 volts. The open-circuit voltage is over 2000 volts.

The power supply also gives 6.5 amperes at 10 volts ac. The 10-volt supply is center-tapped at 5 volts.

**Meters:** The d-c voltage and the load current are indicated by meters mounted on the panel. A panel knob controls the input to the rectifiers.

**Regulation:** The internal output resistance of the power-supply unit corresponds to about 1100 ohms for load currents of 50–150 ma. For lower load currents the internal output resistance increases to about 20,000 ohms at no load. The 1000-cycle internal output impedance is equivalent to 1.1  $\mu$ f.

**Supply:** The power-supply unit will operate from a

105–120 volt, 50–60 cycle line. A suitable power cord is supplied with the instrument.

**Power Consumption:** With the a-c and d-c supplies operating at full load, the power consumption from the mains is about 380 watts. Under these conditions the loss in the power-supply unit is about 90 watts including rectifier cathode power.

**Hum Voltage:** At full-load current the hum voltage is less than 3 volts or 0.2% of full-load voltage. For lower load currents, the hum decreases.

**Tubes:** Two 866-A-type rectifiers are supplied.

**Mounting:** The instrument is suitable for table or relay-rack mounting.

**Dimensions:** (Length) 19½ x (depth) 11½ x (height) 9 inches, over-all. Panel, 19 x 8¾ inches.

**Net Weight:** 73 pounds.

Type	Code Word	Price
673-A	AGONY	\$180.00

PATENT NOTICE. See Note 11, page v.

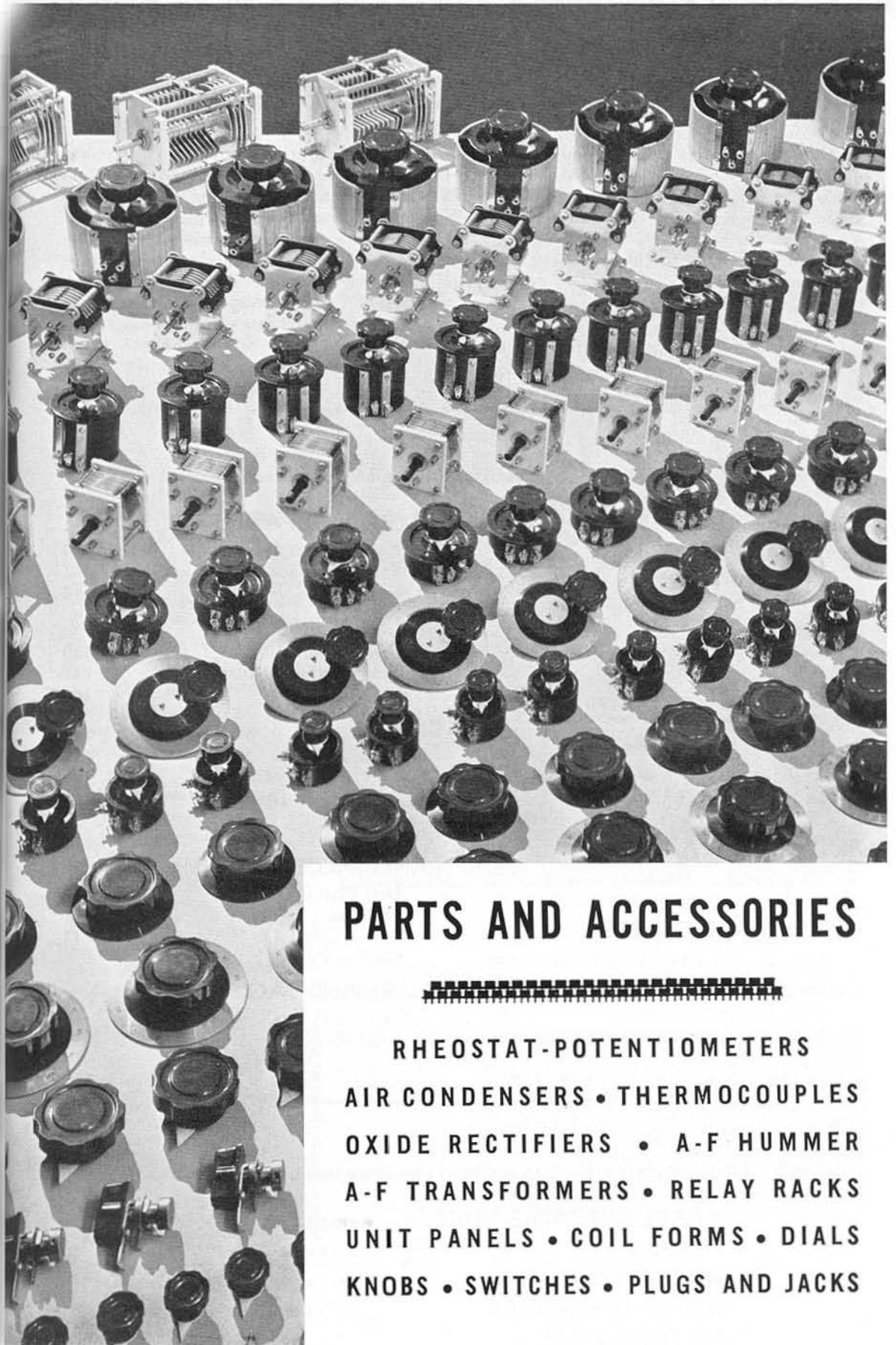

## **PARTS AND ACCESSORIES**



**RHEOSTAT-POTENTIOMETERS  
AIR CONDENSERS • THERMOCOUPLES  
OXIDE RECTIFIERS • A-F HUMMER  
A-F TRANSFORMERS • RELAY RACKS  
UNIT PANELS • COIL FORMS • DIALS  
KNOBS • SWITCHES • PLUGS AND JACKS**

## PARTS AND ACCESSORIES

**D**ESIGN engineers and experimentalists in the radio, electrical, and allied industrial fields will find in this section a variety of unusual accessories that are obtainable nowhere else.

Since 1915 General Radio has manufactured laboratory equipment, frequency-measuring equipment, and components for the Navy, Army, Coast Guard, and other Government services; and for commercial and broadcast

companies, educational institutions, laboratories, and other manufacturers. A reputation has been acquired for building instruments of ruggedness, precision, and dependability.

The parts and accessories which this section will introduce to many new customers have all been designed for use in our own equipment. They measure up in every way to the quality standards on which our excellent reputation is based.

---

The following list summarizes the contents of this section

### RESISTANCE DEVICES

Rheostat-Potentiometers	Page 127-131
Voltage Dividers	131

### CONDENSERS

Variable Air Condensers	132-134
-------------------------	---------

### METERS AND ACCESSORIES

Oxide Rectifier	134
Vacuum Thermocouples	136
Direct-Current Galvanometer	135

### AUDIO OSCILLATORS

Microphone Hummer	137
-------------------	-----

### AUDIO TRANSFORMERS

Input and Interstage Transformers	138
Output Transformers	140
Wide Range Transformers	142
Impedance-Matching Transformers	144

### RACKS AND PANELS

Relay Racks	Page 146
Universal Rack	147
Unit Panels	147-149

### INDUCTORS

Plug-in Inductors	150
Transmitting Inductors	151
R-F Choke	159

### DIALS

Precision Dials	152
Friction-Drive Dials	153, 154
Direct-Drive Dials	153, 154

### KNOBS

155

### PANEL ACCESSORIES

Dial Plates	154
Switches	156
Switch Contacts	156, 157
Binding Posts	157

### PLUGS AND JACKS

Large and small, single- and double-plug units	158
--	-----

---

**OTHER UNMOUNTED DEVICES** are listed elsewhere in this catalog. These include

DECADE RESISTANCE UNITS	on pages 14 to 18
VARIACS	on pages 8 to 10
VOLUME CONTROLS	on pages 24 to 26
DECADE CONDENSERS	on page 40
AIR CONDENSERS	on pages 30 to 35



## RHEOSTAT-POTENTIOMETERS

(VOLTAGE DIVIDERS)

The complete line of adjustable resistors described on the following pages is the direct outgrowth of the need for filament-current controls in vacuum-tube circuits. Other applications are found in all kinds of electrical apparatus where vacuum tubes, resistance bridges and thermocouples are involved.

Units are available from stock with power-dissipation ratings as high as 250 watts and maximum-resistance ranges extending from 0.75 ohm to 200,000 ohms.

Because of the "straight through" shaft construction, these rheostat-potentiometers may be ganged up on the same shaft to provide simultaneous variations of many separate elements under single control. Complicated fader networks may be built up by using flexible couplings or by the substitution of a single shaft of insulating material passing through all of the controls.

All but largest and smallest types are interchangeable on the standard three-hole mounting shown below. When ganged, they may be set up back to back on either side of a sheet support.

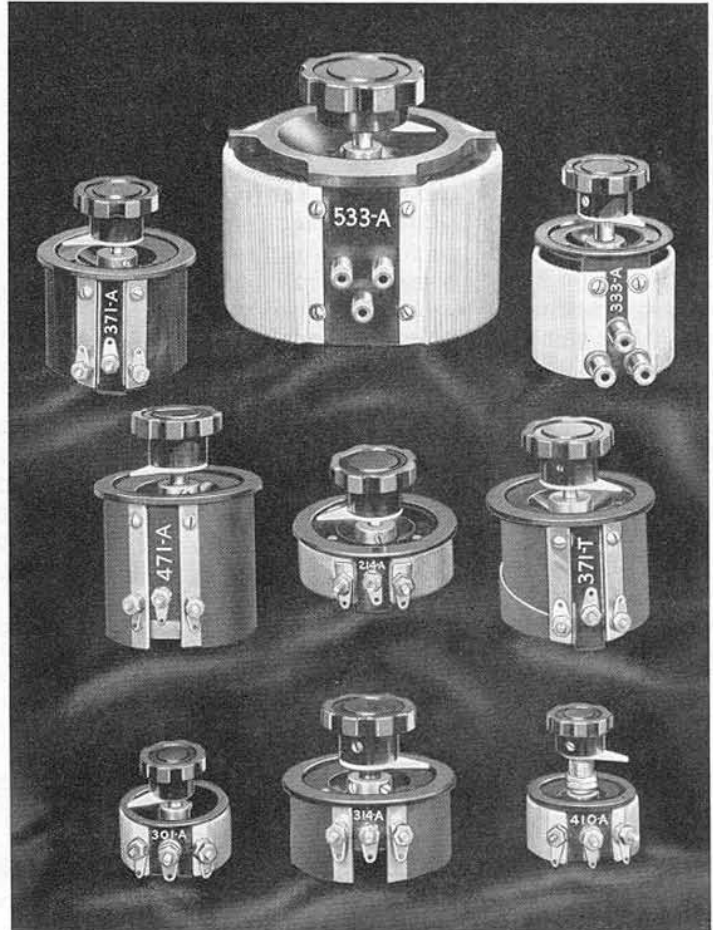

### AS PANEL-MOUNTING MODELS

Every General Radio rheostat-potentiometer is furnished ready for panel mounting, as shown in the above photograph, but every type except one (TYPE 410) can, by a few moments' work with a screwdriver, be converted for top-of-table mounting as shown on the following pages in photographs accompanying the detailed description of each unit.

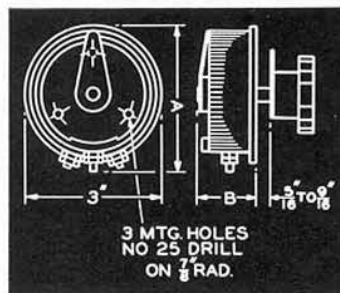

Standard 3-hole mounting method for rheostat-potentiometers

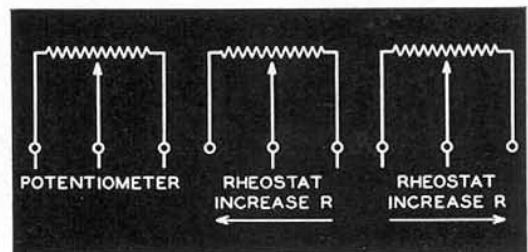

Any potentiometer can also be used as a rheostat for either direction of rotation. There is no off position

TYPE 371 RHEOSTAT-POTENTIOMETER



Rheostat-potentiometers in this series have their resistors wound on a thin linen-bakelite strip which is then bent around the bakelite supporting form. The contact arm is a single blade that wipes the edge of the resistor.

Allowable power dissipation is 20 watts.

Values of maximum resistance between 1 ohm and 50,000 ohms can be supplied from stock, but others within the power-rating limit can be built to order.

In addition to the so-called "linear" units in which resistance is proportional to the angle through which the blade has turned, a unit having a tapered winding is available. In this (TYPE 371-T) the resistance is approximately proportional to the square of the angle, increasing with clockwise rotation of the knob in a panel-mounted unit. Other resistor shapes, such as logarithmic tapers, may be ordered.

SPECIFICATIONS

**Power Rating:** 20 watts; TYPE 371-T, 8 watts.

**Rotation Angle:** 303° (approx.). No OFF position.

**Shaft:** Steel, 1/4-inch diameter.

**Knob:** TYPE 637-G.

**Mounting:** Standard 3-hole; machine screws, nuts, and template furnished. Supplied as panel type, easily converted for table mounting.

**Dimensions:** See sketch on preceding page: A = 3 1/8, B = 2 1/2 inches.

**Net Weight:** 6 ounces.

Type	Maximum Resistance	Maximum Current	Code Word	Price
371-A	1 Ω	4.5 a	RALLY	\$4.00
371-A	5 Ω	2.0 a	RELAY	4.00
371-A	1000 Ω	140 ma	REDAN	4.00
371-A	2500 Ω	90 ma	REFIT	4.00
371-A	5000 Ω	60 ma	ROTOR	4.00
371-A	10,000 Ω	45 ma	ROWDY	4.00
371-A	18,000 Ω	30 ma	RULER	4.00
371-A	50,000 Ω	20 ma	SATYR	4.00
*371-T	10,000 Ω	28 ma	SULLY	4.00

\* Tapered model.

TYPE 214-A RHEOSTAT-POTENTIOMETER

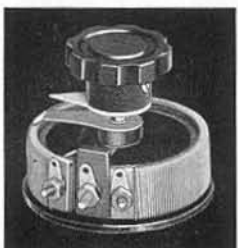

This unit has the same type of construction as the TYPE 371 Rheostat-Potentiometer described above, except that the winding form is narrower and the power rating and maximum resistance

values are, accordingly, smaller.

The resistor is wound on a linen-bakelite strip and the contact member is a single blade that wipes the edge of the winding. Maximum power dissipation is conservatively placed at 9 watts, values of current corresponding to which are given in the price list. Maximum resistance values range from 0.75 to 2500 ohms, but other sizes within the power-rating limit can be built to order.

Units of this type are more suitable for battery-operated installations where space is at a premium or where critical filament potentials must be maintained.

SPECIFICATIONS

**Power Rating:** 9 watts, see current rating below.

**Rotation Angle:** 315°. No OFF position.

**Shaft:** Steel, 1/4-inch diameter.

**Knob:** TYPE 637-G.

**Mounting:** Standard 3-hole; machine screws, nuts, and template furnished. Supplied as panel type, easily converted for table mounting.

**Dimensions:** See sketch on preceding page: A = 3 1/4, B = 1 1/4 inches.

**Net Weight:** 5 ounces.

Type	Maximum Resistance	Maximum Current	Code Word	Price
214-A	0.75 Ω	3.5 a	SHINY	\$1.50
214-A	2 Ω	2.1 a	RUDDY	1.50
214-A	7 Ω	1.1 a	RURAL	1.50
214-A	20 Ω	0.67 a	RAZOR	1.50
214-A	50 Ω	425 ma	RAPID	1.50
214-A	100 Ω	300 ma	RIVET	1.50
214-A	200 Ω	210 ma	EMPTY	1.50
214-A	400 Ω	160 ma	ROBIN	1.50
214-A	1000 Ω	95 ma	ENACT	1.50
214-A	2500 Ω	60 ma	SYRUP	1.50

## TYPE 471-A RHEOSTAT-POTENTIOMETER

This rheostat-potentiometer is one of two types that have constructional features which adapt them for use in high-impedance vacuum-tube circuits. The requirements for this service are severe in that not only must the unit itself have a high resistance, but, because of the low power levels and amplification of all disturbances by the later stages, no contact noise can be tolerated.

In order to meet these requirements the high resistance is obtained by winding the card with fine wire and then protecting it externally from mechanical damage or derangement of the turns by means of a securely anchored band of linen bakelite.

Low noise levels are assured through the use of a contact arm bearing four separate wiping fingers whose average contact resistance is essentially constant for any position of the knob. The unit may be mounted directly on a

metal panel without the necessity of insulating bushings, for the insulated shaft removes all possibility of short circuits as well as any hum that would be introduced by the operator's hand.

The winding form has the same diameter with a slightly greater depth than that of the TYPE 371 Rheostat-Potentiometer described on the opposite page, but the allowable power dissipation is smaller because of the bakelite protecting strip. Values of total resistance as high as 200,000 ohms are available. Special sizes or tapered models with various characteristics can be built to order.



### SPECIFICATIONS

**Power Rating:** 12 watts.

**Rotation Angle:** 294° (approx.). No OFF position.

**Shaft:** Bakelite, 3/8-inch diameter.

**Knob:** TYPE 637-H.

**Mounting:** Standard 3-hole; machine screws, nuts, and template furnished. Supplied as panel type, easily converted for table mounting.

**Dimensions:** See sketch on second preceding page: A=3 1/8, B=2 5/8 inches.

**Net Weight:** 9 ounces.

Type	Maximum Resistance	Maximum Current	Code Word	Price
471-A	100 Ω	330.0 ma	EQUIP	\$6.00
471-A	1000 Ω	104.0 ma	ERASE	6.00
471-A	10,000 Ω	33.0 ma	ERECT	6.00
471-A	50,000 Ω	14.7 ma	ERODE	6.00
471-A	100,000 Ω	10.4 ma	ERUPT	6.00
471-A	200,000 Ω	7.3 ma	ESKER	6.00

## TYPE 314-A RHEOSTAT-POTENTIOMETER

Of the same mechanical and electrical design as the TYPE 471-A Rheostat-Potentiometer described above, this unit differs from it in having the shorter winding form. It has the protected resistor, the bakelite shaft, and the 4-finger contact arm.

The winding form has the same depth, diameter, and arrangement of mounting holes as the TYPE 214-A Rheostat-Potentiometer described at the bottom of the opposite page,

but because the winding is protected, the allowable power dissipation is smaller. Resistances as high as 20,000 ohms are available from stock, and special sizes within the power-rating limit can be built to order.

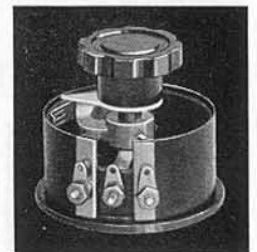

### SPECIFICATIONS

**Power Rating:** 6 watts.

**Rotation Angle:** 294° (approx.). No OFF position.

**Shaft:** Bakelite, 3/8-inch diameter.

**Knob:** TYPE 637-H.

**Mounting:** Standard 3-hole; machine screws, nuts, and template furnished. Supplied as panel type, easily converted for table mounting.

**Dimensions:** See sketch on second preceding page: A=3 1/4, B=1 3/8 inches.

**Net Weight:** 6 ounces.

Type	Maximum Resistance	Maximum Current	Code Word	Price
314-A	200 Ω	165 ma	ENATE	\$4.00
314-A	600 Ω	95 ma	ENDOW	4.00
314-A	2000 Ω	52 ma	ENEMY	4.00
314-A	6000 Ω	30 ma	ENJOY	4.00
314-A	20,000 Ω	16 ma	ENROL	4.00

TYPE 533-A RHEOSTAT-POTENTIOMETER

This is a heavy-duty unit, which can dissipate 250 watts under continuous load. The frame is of moulded bakelite, and the resistance element is wound on an asbestos-covered aluminum strip that serves to distribute the heat to be dissipated to all portions of the element for better radiation. This unit, and the one listed below, should not be used in closed compartments or where a means of ventilation has not been provided to keep the temperature of associated apparatus at a reasonable value.

Both types are equipped with three TYPE 138-V combination binding post and plug jacks set on standard spacing so that tight plug-in connections may be made to obtain immediately a rheostat of either direction of rotation for increased resistance, or a fixed resistance from which a variable tap is to be taken.

Seven maximum resistance values are carried in stock but others of the same power rating can be built to order.

SPECIFICATIONS

Power Rating: 250 watts, see current rating below.  
 Rotation Angle: 305° (approx.). No OFF position.

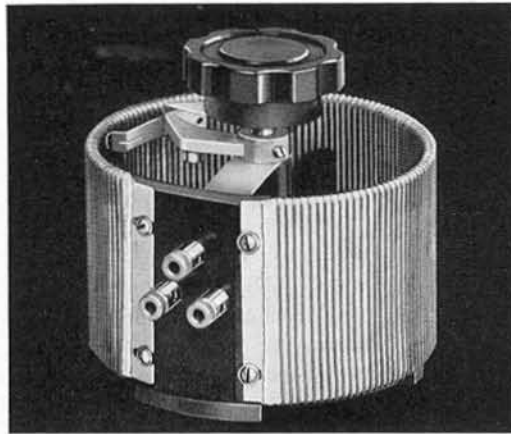

Shaft: Steel, 3/8-inch diameter.

Knob: TYPE 637-Q.

Mounting: Table type supplied, easily converted for panel mounting; see accompanying sketch. Machine screws, nuts, and a drilling template are furnished.

Dimensions: See accompanying sketch.

Net Weight: 1 7/8 pounds.

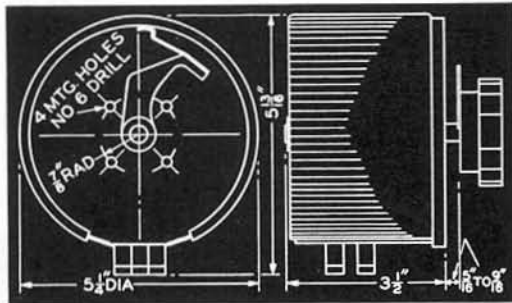

Type	Maximum Resistance	Maximum Current	Code Word	Price
533-A	1 Ω	15.8 a	MOLAR	\$6.00
533-A	3 Ω	9.1 a	MONAD	6.00
533-A	10 Ω	5.0 a	MORAL	6.00
533-A	30 Ω	2.9 a	MOTTO	6.00
533-A	100 Ω	1.6 a	MUGGY	6.00
533-A	300 Ω	0.9 a	MUMMY	6.00
533-A	600 Ω	0.6 a	MUSTY	6.00

TYPE 333-A RHEOSTAT-POTENTIOMETER



This unit, although smaller, has the same constructional features as the TYPE 533-A Rheostat - Potentiometer described above. It has the standard 3-hole mounting which makes it interchangeable with the units shown on the next page.

Its power dissipation rating is 100 watts.

SPECIFICATIONS

Power Rating: 100 watts.  
 Rotation Angle: 289° (approx.). No OFF position.

Shaft: Steel, 3/8-inch diameter.

Knob: TYPE 637-H.

Mounting: Standard 3-hole; machine screws, nuts, and template furnished. Supplied as panel type, easily converted for table mounting.

Dimensions: See sketch on third preceding page: A=4, B=2 5/8 inches.

Net Weight: 11 ounces.

Type	Maximum Resistance	Maximum Current	Code Word	Price
333-A	1 Ω	10.0 a	VALOR	\$4.00
333-A	3 Ω	5.8 a	VAPID	4.00
333-A	10 Ω	3.2 a	VENUS	4.00
333-A	30 Ω	1.9 a	VIGIL	4.00
333-A	100 Ω	1.0 a	VIGOR	4.00
333-A	300 Ω	0.6 a	VILLA	4.00
333-A	600 Ω	0.4 a	VIPER	4.00



## TYPE 301-A RHEOSTAT-POTENTIOMETER



Rated at a maximum power dissipation of 5 watts, this is the smallest rheostat-potentiometer we manufacture. Because of its compactness it is ideal for filament controls on small tubes.

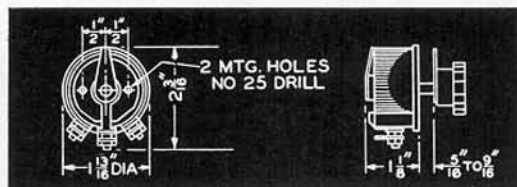

**Dimensions:** See accompanying sketch.  
**Net Weight:** 3 ounces.

### SPECIFICATIONS

**Power Rating:** 5 watts; 3 watts on 10,000  $\Omega$  and 20,000  $\Omega$  models.

**Rotation Angle:** 254° (approx.). No OFF position.

**Shaft:** Steel, 1/4-inch diameter. **Knob:** TYPE 637-A.

**Mounting:** Panel type supplied; easily converted for table mounting. Machine screws, nuts, and template furnished.

Type	Maximum Resistance	Maximum Current	Code Word	Price
301-A	6 $\Omega$	1 a	PALSY	\$1.00
301-A	12 $\Omega$	0.7 a	REMIT	1.00
301-A	25 $\Omega$	0.5 a	RENEW	1.00
301-A	200 $\Omega$	175 ma	REBUS	1.00
*301-A	10,000 $\Omega$	17 ma	CURRY	1.50
*301-A	20,000 $\Omega$	12 ma	CRUMB	1.50

\* Supplied with linen-bakelite protecting strip.

## TYPE 410-A RHEOSTAT-POTENTIOMETER



This is identical with the TYPE 301-A Rheostat-Potentiometer described above, except that it is equipped for single-hole mounting, often a convenient feature. This unit cannot ordinarily be used on metal panels.

### SPECIFICATIONS

**Power Rating:** 5 watts.

**Rotation Angle:** 254° (approx.). No OFF position.

**Shaft:** Steel, 1/4-inch diameter. **Knob:** TYPE 637-A.

**Mounting:** Single-hole panel type only.

**Dimensions:** See accompanying sketch.

**Net Weight:** 3 ounces.

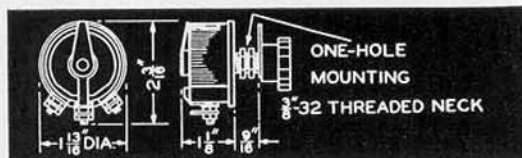

Type	Maximum Resistance	Maximum Current	Code Word	Price
410-A	6 $\Omega$	1 a	SABOT	\$1.00
410-A	12 $\Omega$	0.7 a	SALON	1.00
410-A	25 $\Omega$	0.5 a	SALTY	1.00
410-A	200 $\Omega$	175 ma	SATIN	1.00

## TYPE 154 VOLTAGE DIVIDER

These adjustable voltage dividers have rotary taps instead of the usual sliders. TYPE 154-A is similar in construction to TYPE 314-A Rheostat-Potentiometer; TYPE 154-B is similar

to TYPE 471-A. Three adjustable taps are supplied on each model. Six values of total resistance are available.

Type	Total Resistance	Code Word	Price
154-A	5000	DIVIDARMY	\$6.50
154-A	10,000	DIVIDBOAT	6.50
154-A	20,000	DIVIDCAPE	6.50
154-B	50,000	DIVIDEYRE	8.50
154-B	100,000	DIVIDFACT	8.50
154-B	200,000	DIVIDGIRL	8.50

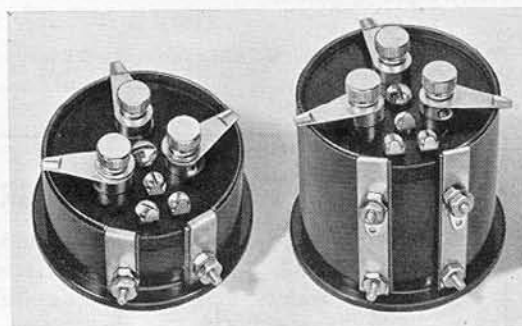

## TYPE 568 VARIABLE AIR CONDENSER

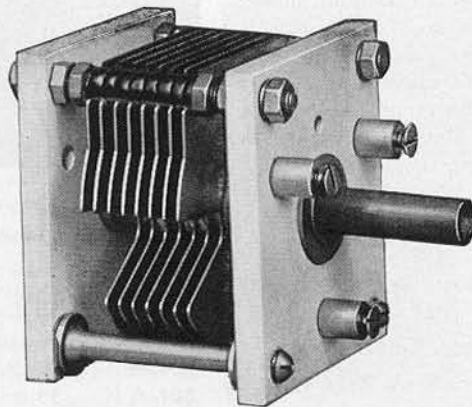

This is a condenser of rugged construction for use as a tuning element in short-wave receivers, transmitters, and wavemeters. It is designed for tandem mounting, a hollow shaft permitting the use of a single long bakelite or metal shaft for driving several units. The isolantite end plates help to keep the losses at a minimum. Contact to the rotor is made through

an eight-fingered conical bearing kept under heavy spring pressure, and, in order to reduce resistance, each plate stack is soldered into an integral piece before assembly.

Two sizes are available, one of 175- $\mu\text{mf}$  with straight-line-capacitance plates and the other of 50- $\mu\text{mf}$  with straight-line-frequency plates of decreasing frequency with clockwise rotation.

## SPECIFICATIONS

**Plate Shape:** Straight-line capacitance for TYPE 568-D; approximately straight-line frequency for TYPE 568-K.

**Supports:** End plates are of isolantite, treated to prevent moisture absorption.

**Low Losses:**  $R\omega C^2$  is approximately  $0.03 \times 10^{-12}$ .

**Maximum Voltage:** 500 volts, peak.

**Knobs:** None supplied. Shaft diameter,  $\frac{3}{8}$ -inch; rotation angle  $180^\circ$  for TYPE 568-D,  $270^\circ$  for TYPE 568-K.

**Mounting:** See accompanying sketch. Drilling template and 3 flat-head screws are furnished.

**Dimensions:** See sketch.

**Net Weight:**  $\frac{3}{4}$  pound.

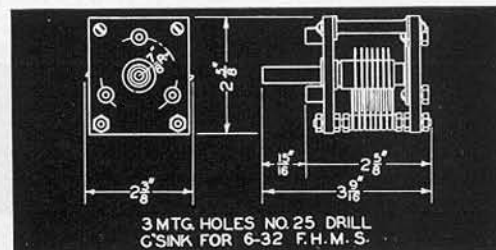

Type	Nominal Capacitance		Code	Price
	Maximum	Minimum		
568-D	175 $\mu\text{mf}$	12 $\mu\text{mf}$	CLOVE	\$4.00
568-K	50 $\mu\text{mf}$	12 $\mu\text{mf}$	CLOUD	4.00

PATENT NOTICE. General Radio condensers which incorporate special features are manufactured under United States Patent. See Notes 3, 10, page v.

## OTHER AIR CONDENSERS

Laboratory-type condensers, both mounted and unmounted models, are listed on pages 30 to 35. These include precision condensers, auxiliary balancing condensers for bridges, and condensers suitable for use in laboratory instruments.

## TYPES 334 and 335-Z VARIABLE AIR CONDENSERS

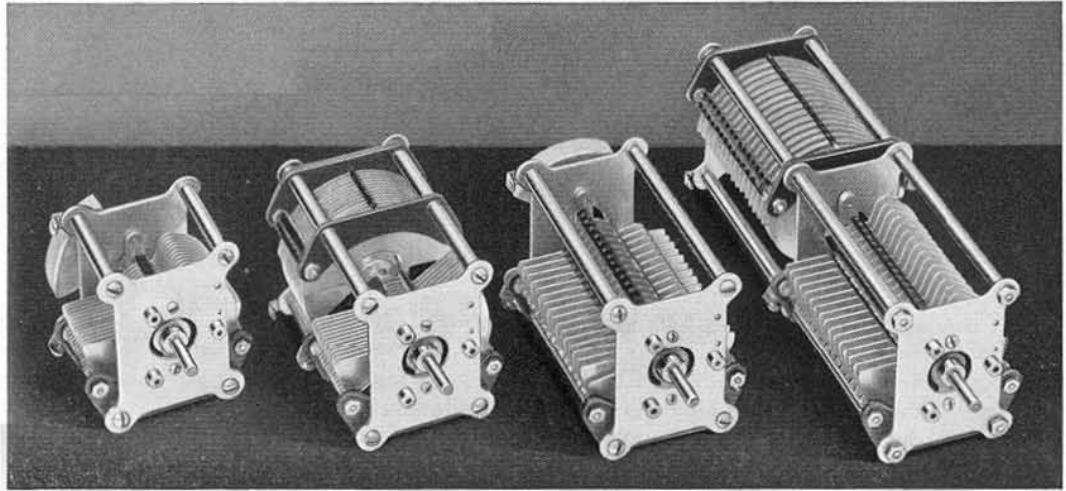

Left to right: TYPE 334-F, TYPE 335-Z, TYPE 344-R, and TYPE 334-Z

This group of condensers is available in a variety of sizes for general experimental use. They have soldered brass plates and metal end plates which are grounded to the rotor stack and to the shaft. Insulation is of hard rubber.

Models rated in the price list at 1500 volts, peak, have double the plate spacing of those rated at 500 volts, peak. The former are intended for use in power oscillators or intermediate stages of medium-power transmitters.

### SPECIFICATIONS

**Plate Shape:** Approximately straight-line wavelength, decreasing wavelength for clockwise rotation, for all except TYPE 335-Z which has straight-line-capacitance plates.

**Supports:** Two small sections of first-quality hard rubber support the stator.

**Low Losses:**  $R\omega C^2$  is approximately  $0.07 \times 10^{-12}$ .

**Knobs and Dials:** None are supplied. Shaft diameter,  $\frac{1}{4}$  inch; rotation angle,  $180^\circ$  for all sizes.

Types 334-Z and 335-Z have balanced rotors; all others, a counterweight.

**Mounting:** Standard General Radio 3-hole mounting. See accompanying sketch. Drilling template and 3 flat-head screws are furnished.

Four removable feet are furnished with each of the high-voltage models.

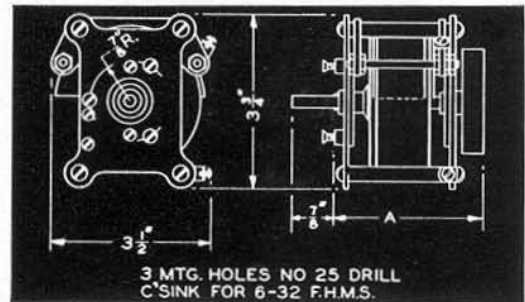

**Terminals:** See illustration.

**Dimensions:** See accompanying outline drawing. Depth (dimension A) is given in the price list.

Type	Nominal Capacitance		Maximum Peak Voltage	Depth (A)	Net Weight	Code Word	Price
	Maximum	Minimum					
335-Z	1150 $\mu\text{mf}$	50 $\mu\text{mf}$	500 v	$5\frac{1}{4}$ in.	$2\frac{1}{8}$ lb.	BOGUS	\$6.00
334-F	500 $\mu\text{mf}$	20 $\mu\text{mf}$	500 v	$3\frac{5}{16}$ in.	$1\frac{1}{2}$ lb.	BEGIN	3.25
334-K	250 $\mu\text{mf}$	15 $\mu\text{mf}$	500 v	$2\frac{5}{8}$ in.	1 lb.	BELOW	2.75
334-Z	500 $\mu\text{mf}$	35 $\mu\text{mf}$	1500 v	$10\frac{1}{8}$ in.	$3\frac{3}{8}$ lb.	BOGEY	10.00
334-R	250 $\mu\text{mf}$	30 $\mu\text{mf}$	1500 v	$6\frac{1}{2}$ in.	2 lb.	BISON	5.50
334-T	100 $\mu\text{mf}$	15 $\mu\text{mf}$	1500 v	$3\frac{1}{4}$ in.	$1\frac{1}{8}$ lb.	BILLY	2.75
334-V	50 $\mu\text{mf}$	10 $\mu\text{mf}$	1500 v	$2\frac{5}{8}$ in.	$\frac{5}{8}$ lb.	BIPED	2.50

TYPE 368 VARIABLE AIR CONDENSER

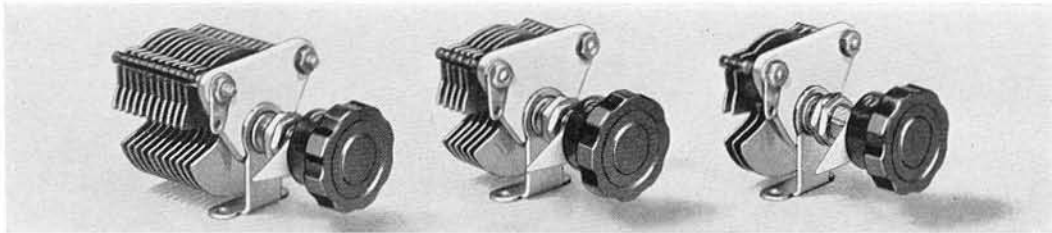

TYPE 368-C

TYPE 368-B

TYPE 368-A

This condenser is useful as a balancing or vernier condenser in various vacuum-tube circuits, and many amateurs use it as a tuning condenser in receivers for the high-frequency (short-wave) bands. It has a single, isolantite

end plate, single bearing, and can be used for single-hole panel mounting as well as for mounting on a baseboard by means of the angle bracket.

SPECIFICATIONS

**Capacitance Range:** See price list.

**Plate Shape:** Straight-line capacitance.

**Support:** A single, isolantite end plate supports the entire assembly.

**Low Losses:**  $R\omega C^2$  is approximately  $0.004 \times 10^{-12}$ .

**Maximum Voltage:** 500 volts, peak.

**Knob:** TYPE 637-A Knob supplied.

**Mounting:** Bushing for single-hole panel mounting; bracket for baseboard mounting. See sketch.

**Dimensions:** See sketch and price list.

**Net Weight:** Approximately 3 ounces, all sizes.

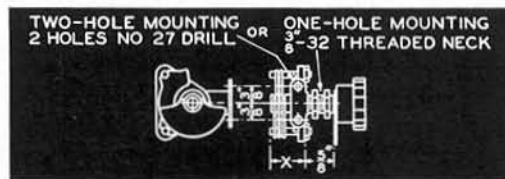

Type	Capacitance		Depth (X)	Code Word	Price
	Max.	Min.			
368-A	15 $\mu\mu\text{f}$	2 $\mu\mu\text{f}$	1 $\frac{1}{16}$ in.	BULLY	\$0.75
368-B	50 $\mu\mu\text{f}$	3 $\mu\mu\text{f}$	1 $\frac{5}{16}$ in.	BURIN	1.00
368-C	100 $\mu\mu\text{f}$	4 $\mu\mu\text{f}$	1 $\frac{1}{2}$ in.	AZURE	1.50

TYPE 492-A OXIDE RECTIFIER

One kind of junction of copper oxide has the property of unilateral conductivity. The TYPE 492-A Oxide Rectifier consists of four copper-oxide rectifier units arranged in the form of a bridge, thus providing full-wave rectification of an applied alternating voltage. The rectifier is useful for operating relays and for measuring alternating voltages by means of d-c instruments.

The unit is offered in its present form for experimental purposes and it must be realized in this connection that changes in both sensitivity and frequency response with output load and impressed voltage are to be expected. Fixed resistors can be inserted in series or in shunt with the rectifier unit to reduce these

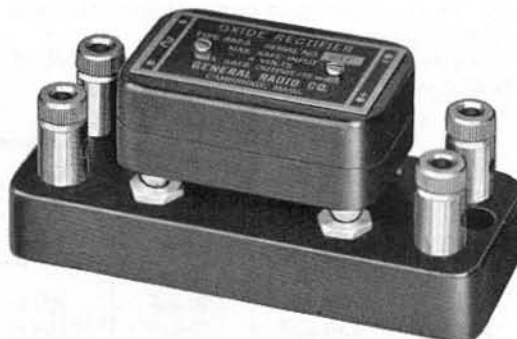

A TYPE 492-A Oxide Rectifier and a TYPE 274-RJ Mounting Base

apparent variations. TYPE 500 Resistors are recommended.



## SPECIFICATIONS

**Frequency Error:** The rectifier may be used without appreciable frequency error at frequencies below 5000 cycles per second.

**Temperature Error:** Temperature errors of about 5% may be expected between normal extreme temperatures. Maximum sensitivity is obtained with a load of 5000 to 7000 ohms. This value should be used when the instrument is operating a relay. If a 1-milliamper meter of 400- or 500-ohms resistance is used, full-scale deflection will be obtained at about 2 volts across the rectifier input.

The maximum current output from the rectifier should not exceed 15 ma, nor should the impressed voltage exceed 3 volts.

Obviously, the apparent change of impedance with resistance can be greatly reduced by proper use of series and shunt resistance on the input side.

**Mounting:** As illustrated. Plugs fit TYPE 274-RJ Mounting Base as shown. The base is not supplied.

**Dimensions:** (Length)  $2\frac{1}{8}$  x (breadth)  $1\frac{3}{8}$  x (depth)  $\frac{3}{4}$  inches, exclusive of plugs.

**Net Weight:** 2 ounces.

Type	Code Word	Price
492-A	FLORA	\$7.00

## TYPE 588-AM DIRECT-CURRENT METER

This is a direct-current galvanometer having full-scale sensitivity of 500 microamperes and a resistance of 10.0 ohms (5 millivolts) which adapts it for use in conjunction with TYPE 493 Thermocouples. Since each thermocouple must be individually calibrated, the scale is laid out with 50 equal divisions marked from 0 to 50, thus making easy the preparation and reading of calibration curves. The meter is supplied with the TYPE 298-B Meter Mounting which has jacks for plugging in the thermocouple.

The input terminals are set on the General Radio standard  $\frac{3}{4}$ -inch spacing to take all double plugs of the TYPE 274 series.

This meter may also be used with the TYPE 492-A Oxide Rectifier, described previously.



## SPECIFICATIONS

**Range:** 0 to 500 microamperes full scale.

**Resistance:** 10 ohms,  $\pm 0.5\%$ .

**Scale:** The  $2\frac{1}{8}$ -inch scale is divided into 50 equal divisions marked 0 to 50.

**Calibration:** Full-scale deflection is adjusted to within 2% of the specified value of 500 microamperes. Other points are not calibrated, but de-

flexion is approximately proportional to current over the entire range.

**Adjustment:** A screw is provided in the glass face for making the zero adjustment.

**Dimensions:** (Length)  $5\frac{7}{8}$  x (width)  $3\frac{1}{16}$  x (height)  $2\frac{7}{8}$  inches.

**Net Weight:**  $1\frac{1}{8}$  pounds.

Type	Range	Code Word	Price
588-AM	0-500 microamperes	OURMETMUSH	\$26.00

## TYPE 493 VACUUM THERMOCOUPLE

The vacuum thermocouple presents a convenient means for measuring high-frequency current. It consists of a junction of two dissimilar metals which, when heated, sets up a direct voltage capable of actuating a d-c indicating meter.

This type of instrument is a true integrating ammeter since the d-c meter reading is a function of the r-m-s current in the heater circuit. For this reason a thermocouple and meter give results that are independent of waveform, and frequency errors can occur only at frequencies so high that the stray capacitances in the couple mounting become significant (beyond 20 Mc). The couple may be calibrated on direct current.

Both the contact type and the separate-heater type are available. In the contact type the heater circuit is in electrical contact with the couple circuit. In the separate-heater type the heating element is separated from the couple junction by a small bead of glass, thus electrically insulating the two circuits while providing good thermal contact.

The contact-type couples are easier to build and consequently less expensive, and yet our method of building the separate-heater models



TYPE 493 Thermocouples are mounted in a bakelite case with plugs to fit a TYPE 274-RJ Mounting Base

has been so greatly improved that a comparable degree of sensitivity is obtained. Separate-heater couples can, of course, be used at high frequencies with fewer precautions against the effects of stray capacitances to ground.

Thermo-junctions are mounted in an evacuated glass bulb. The vacuum reduces heat conduction from the couple as well as the effect of external temperature variations. The glass bulb is surrounded by felt and mounted in the bakelite container shown in the illustration, ready for mounting in a TYPE 274-RJ Mounting Base.

## SPECIFICATIONS

**Type of Couple:** The type number "493" is used to designate all thermocouples described here. Contact-type thermocouples are indicated by means of a single letter which also designates the heater current, *e.g.*, 493-A. The letter "H" is used to indicate a separate-heater type of couple, *e.g.*, 493-HA.

**Couple Resistance:** The resistance of all couples is adjusted to between 10 and 12 ohms, the value engraved on each nameplate being accurate to 0.1 ohm of the actual couple resistance. This is a significant specification since the user can select a meter of the proper resistance and sensitivity to give full-scale deflection without overloading the thermoelement by considering the couple to be a generator of internal resistance equal to the couple resistance and developing an open-circuit voltage of 10 millivolts when the heater current is that given in the table on the next page.

**Heater Resistance:** Heaters are adjusted to within  $\pm 10\%$  of the values given in the table. The actual value engraved on the nameplate is given to within 0.01 ohm for TYPES 493-A, 493-C, 493-HA, and 493-HC; to within 0.1 ohm for TYPES 493-E and 493-HE; and to within 1 ohm for TYPES 493-H, 493-K, 493-HH, and 493-HK.

**Electrical Sensitivity:** The price list gives the heater current required to produce 10 millivolts across the couple terminals on open circuit. This value is held to within  $+10\%$  and  $-15\%$ .

**Thermal Sensitivity:** 26 microvolts per degree Fahrenheit.

**Overload:** All heaters will withstand a continuous overload of 50% of the current given in price list.

**Coefficient of Resistance:** Couple elements, 0.00013 per degree Fahrenheit; heater 0.00009 per degree Fahrenheit.

**Meter:** TYPE 588-AM Direct-Current Meter is recommended for use with these couples.

**Mounting:** Mounted in bakelite case, as illustrated, with plugs to fit TYPE 274 Mounting Bases having four jacks. The TYPE 274-RJ Mounting Base is recommended.

**Dimensions:** (Length)  $2\frac{1}{8}$  x (breadth)  $1\frac{3}{8}$  x (depth)  $\frac{3}{4}$  inches, exclusive of plugs.

**Net Weight:** 2 ounces.

## CONTACT-TYPE COUPLES

Type	Heater Resistance*	Current to Give 10 Millivolts Open Circuit	Code Word	Price
493-A	0.5 Ω	300 ma	FUNNY	\$12.00
493-C	2 Ω	100 ma	FOCUS	12.00
493-E	10 Ω	25 ma	FOLLY	12.00
493-H	100 Ω	8 ma	FORAY	12.00
493-K	450 Ω	4.5 ma	FORUM	12.00

## SEPARATE-HEATER TYPE COUPLES

Type	Heater Resistance*	Current to Give 10 Millivolts Open Circuit	Code Word	Price
493-HA	0.5 Ω	300 ma	EAGER	\$15.00
493-HC	2 Ω	100 ma	EDICT	15.00
493-HE	10 Ω	25 ma	EARLY	15.00
493-HH	100 Ω	8 ma	EASEL	15.00
493-HK	450 Ω	4.5 ma	EDIFY	15.00

\*At rated current.

## TYPE 572-B MICROPHONE HUMMER

### SPECIFICATIONS

**Frequency:** 1000 cycles ±10%.

**Output:** 15 milliwatts, maximum.

**Internal Output Impedance:** 10 or 300 ohms.

**Power Supply:** This oscillator is designed to operate from a 4½-volt battery, Burgess No. 2970, or equivalent.

**Mounting:** Supplied unmounted as illustrated.

**Dimensions:** (Length) 3¼ x (width) 2½ x (height) 1⅝ inches, over-all.

**Net Weight:** 9 ounces.

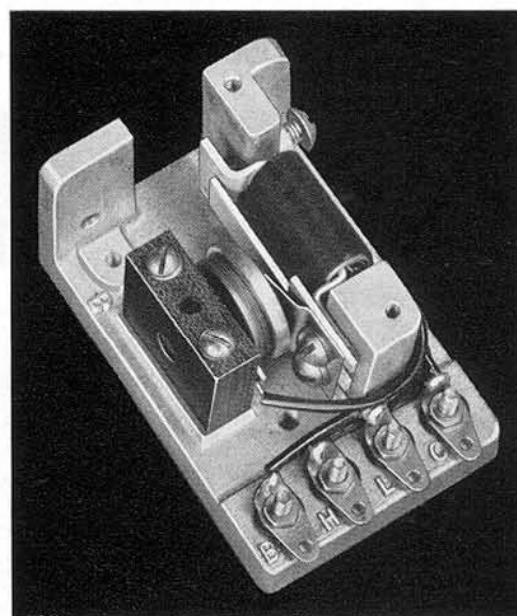
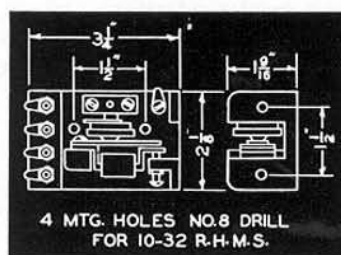

This is an electro-mechanical oscillator in which the frequency is determined by a tuned reed. It is intended for use as a low-power, a-c source for bridge and other measurements where extreme purity of waveform and frequency stability are not essential. The waveform may be improved by the addition of a 0.5-μf condenser, mounting holes for which are provided.

Type	Code Word	Price
572-B	APHIS	\$10.00

## AUDIO-FREQUENCY TRANSFORMERS

In this section is described a complete line of high-quality audio-frequency transformers, including models designed for vacuum-tube-input, vacuum-tube-interstage, vacuum-tube-output, impedance-matching, and circuit-isolation uses.

These transformers have lap-jointed laminated cores of the best grade of silicon steel, the use of which results in the unusually good frequency characteristics that are obtained. By reason of the high current that can be tolerated before saturation occurs, parallel plate feed does not have to be used under normal operating conditions. The transformers are unaffected by mechanical shock, are shielded against electrostatic fields, and, because of thorough 1000-volt insulation, they are proof against breakdown under transient surge peaks. They may be used in permanent installations with the knowledge that they will retain their characteristics through years of use.

To preserve the symmetry of push-pull tapped windings so that subsequent stages

may be truly balanced, the coils of the vacuum-tube-interstage transformers are built up in alternate primary and balanced secondary layers. This construction increases the coupling coefficient of the transformer and decreases the distributed capacitance of both windings, therefore extending the upper-frequency limit without introducing high-frequency resonance peaks on open circuit (interstage) operation.

For use in high-fidelity circuits with unbalanced stages, the light additional loadings recommended in the tables will preserve the frequency characteristics to well within the limits stated. All ratings are conservative and represent the performance that may be expected under the most unpromising conditions.

Experimenters and development engineers will find in these transformers reliable units having negligible insertion losses when they are properly terminated. They may be used without fear of distortion in the many communication, amplifier, line, bridge, balanced, and unbalanced circuits encountered in engineering work.

## VACUUM-TUBE-INPUT AND -INTERSTAGE TRANSFORMERS

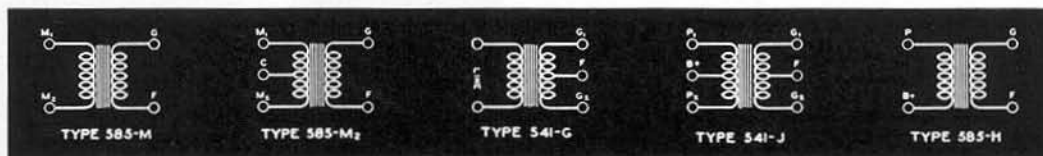

## INPUT TYPES

Carbon microphones, pickups, and mixer sources of from 50 ohms to 400 ohms internal impedance may be matched to a grid through the use of the TYPE 585-M or TYPE 585-M<sub>2</sub> Transformers diagramed above.

Reflectionless line termination for lines between 400 and 600 ohms and coupling to either balanced or unbalanced amplifiers may be obtained with the TYPE 541-G Transformer which is designed especially for this service.

## INTERSTAGE TYPES

For the intermediate stages the TYPE 541-J Transformer will meet all possible arrangements of either single-tube or push-pull connections. It will work from sources ranging from 1000 to 5000 ohms in impedance by using half the primary winding.

Where a greater interstage voltage step-up is desired for unbalanced amplifiers at the expense of a narrowed frequency range, TYPE 585-H is recommended.

## SPECIFICATIONS

**Use:** The most common uses of the transformers are suggested in the second column of the following table. Values of source impedance and primary direct current have been chosen for tubes that are most frequently encountered in practice.

**Frequency Range:** The table gives the frequency range over which the voltage ratio is less than 2 db

below its value on the flat portion of the characteristic. This range holds for operation "Out of" a source having the impedance shown in column three and into the grid or grids of the succeeding stage. For values of source impedance between those tabulated, the frequency range may be found by direct interpolation.



## AUDIO-FREQUENCY TRANSFORMERS

The "Pri. DC" column gives the normal primary current for the transformer when working out of a single tube or the permissible current unbalance when working out of tubes in push-pull. The specified frequency range will be obtained with this value of current. The low-frequency limit is decreased by approximately 25% when no direct current flows. The effect on the frequency characteristic of a 100% increase in "Pri. DC" is negligible at frequencies greater than 80 cycles.

**Turns Ratio:** The ratio of turns of the whole primary winding to the whole secondary winding is given in the "Turns Ratio" column of the table.

**Primary Winding:** The 60-cycle inductance of the whole primary as measured with the tabulated value of "Pri. DC" flowing is given in the "L" column. The maximum value of current that may be applied to any part of the primary is stated in the "I Max." column.

**Mounting:** Each transformer is mounted in a standard drawn-steel, wax-filled Model B case, illustrated on the next page.

**Dimensions:** See dimensioned drawing, Model B case.

**Net Weight:** All types, 3 pounds.

Type	Use	Frequency Range (Down 2 db) <sup>1</sup>				Turns <sup>1</sup> Ratio	Primary		Code Word	Price
		Out of (ohms)	Pri. DC (ma)	From (cycles)	To (cycles)		L <sup>1</sup> (h)	I Max. (ma)		
541-J	P-P Plates to P-P Grids	20,000 <sup>3</sup> to 10,000	0.25 <sup>2</sup> 0.4 <sup>2</sup>	30 25	10,000 13,000	1 to 2.1	150 140	15	ABHOR	\$7.50
	One Plate <sup>4</sup> to P-P Grids	16,000 to 10,000	2.5 5	30 35	11,000 13,000		75 65			
	One Plate <sup>4</sup> to One Grid <sup>4</sup>	16,000 <sup>5</sup> to 10,000 <sup>6</sup> 5000	2.5 5 8	30 35 28	11,000 11,000 12,000		75 65 55			
585-H	One Plate to One Grid	10,000	5	50	7000	1 to 3.2	40	15	TIPSY	6.00
541-G	Line or Mixer <sup>8</sup> to P-P Grids	400-600 <sup>7</sup>	—	30	13,000	1 to 9.7	8	30	ABEAM	10.00
	Line or Mixer <sup>8</sup> to One Grid <sup>4</sup>	400-600 <sup>9</sup>	—	30	13,000					
585-M2	Single- or Double-Button Microphone to Single Grid	400 200 <sup>1</sup>	5 <sup>2</sup> 20	40 40	7000 7500	1 to 13.8	3 2	80	TARRY	6.00
585-M	Single-Button Microphone to Single Grid	200 50	20	45 40	7000 8000	1 to 27.8	0.7	100	TARDY	6.00

<sup>1</sup> Data are for whole of tapped windings.

<sup>2</sup> Dc for 10% unbalance in push-pull connection.

<sup>3</sup> Connect 250,000Ω across each half of secondary.

<sup>4</sup> Use whole winding, P<sub>1</sub> or G<sub>1</sub> to plate or grid.

<sup>5</sup> Connect 75,000Ω between G<sub>1</sub> and F.

<sup>6</sup> Connect 100,000Ω between G<sub>1</sub> and F.

<sup>7</sup> Connect 100,000Ω across each half of secondary. Without resistors response is up 2 db at 11,000 cycles.

<sup>8</sup> To reflect exactly 500Ω to primary, connect 25,000Ω across each half of secondary; for single-grid use, high-frequency limit is then 10,000 cycles.

<sup>9</sup> Connect 35,000Ω between G<sub>1</sub> and F.

## SPECIAL TRANSFORMERS

The General Radio Company has had wide experience in the custom design and production of transformers to meet requirements not covered by stock models. Among these types are transformers with extra and monitoring windings, transformers to operate in mixer circuits of unusual impedance, and to simulate the characteristic of the human ear. Special

transformers for the tripping of control circuits as well as transformers for inclusion in recording seismographs and other scientific research instruments can also be supplied.

Prices will be quoted on inquiry. Please state desired frequency characteristic and the values of generator and load impedances between which the transformer is to work.

VACUUM-TUBE OUTPUT TRANSFORMERS

An output transformer may be selected from the four shown below to couple a vacuum tube to all but the most unusual values of line or speaker impedances. For a large number of these special cases designs are already on hand with the result that these types may be furnished without undue expense or delay.

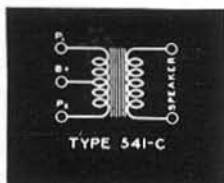

TYPE 541-C

The TYPE 541-C Transformer is available for output uses where it is desired to couple a push-pull, 4000- to 12,000-ohm output stage to the voice coils of one or more dynamic speakers. With multiple loads the optimum impedance ratio of 1300 to 1 should govern the choice of arrangement of secondary connections.

This is the transformer recommended for use with tubes of the following types: 10, 31, 45, 46 (Class A), 49 (Class A), 59 (Class A), 71-A, 89 (Class A), and 112-A.

generator impedances between 700 and 2000 ohms will cause no appreciable change in the frequency characteristic.

The choice of a secondary tap and the arrangement of the speaker connections should be such as to load correctly the output stage. The load presented to the tubes will be the transformer load multiplied by the square of the turns ratio of the transformer for the particular secondary tap used. In particular, the correct load for the 2A3 tubes varies, depending on whether fixed bias or self-bias is used. The table shows the best connections.

Load Impedance		Terminals to Which Load is Connected
(Self-Bias)	(Fixed Bias)	
1.5- 3 ohms	1- 2 ohms	0-2
3 - 5.7 ohms	2- 4 ohms	0-4
5.7-12 ohms	4-10 ohms	0-8

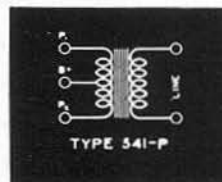

TYPE 541-P

TYPE 541-P Transformer will feed lines of from 400 to 600 ohms impedance from a push-pull stage of output tubes. Its excellent characteristic allows it to be used indiscriminately to interconnect high-fidelity systems with no loss in the over-all frequency range. This transformer is also recommended for feeding any balanced or unbalanced amplifier output into a line-impedance-level mixer system, or for use in the output stage of a microphone pre-amplifier.

TYPE 541-D

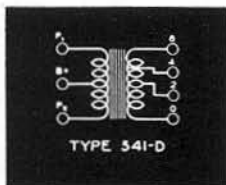

The TYPE 541-D Transformer is a universal output transformer for use with two 2A3 tubes in a balanced (push-pull) stage, although use of

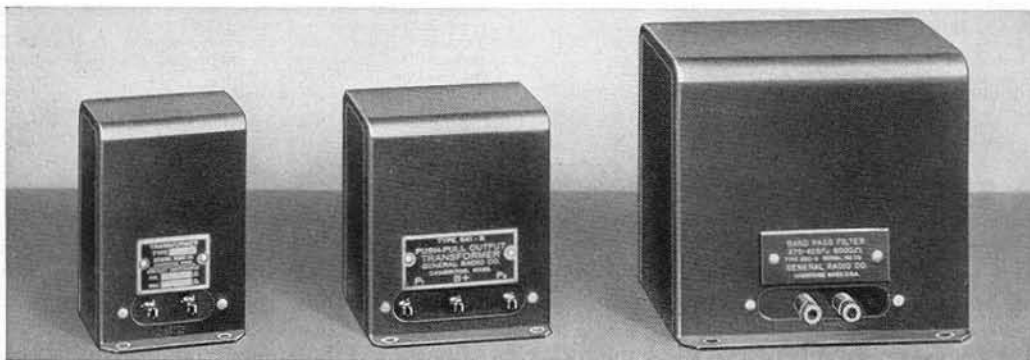

MODEL B

MODEL C

MODEL D

General Radio transformers are mounted in the three sizes of cases shown by the samples above

# AUDIO-FREQUENCY TRANSFORMERS

## SPECIFICATIONS

**Use:** The most common uses of the transformers are suggested in the second column of the following table. Values of source and load impedances and primary direct current have been chosen for conditions that will most frequently be met in practice.

**Frequency Range:** The table gives the frequency range over which the voltage ratio is less than 2 db below its value on the flat-top portion of the characteristic. This range holds for operation "Out of" a source having the impedance shown in column three and "Into" a load of value shown in column four. For values of source and load impedances between those tabulated, the frequency range may be found by direct interpolation.

The "Pri. DC" column gives the normal primary current for the transformer when working out of a single tube or the permissible current unbalance with push-pull input circuits. The specified frequency range will be obtained with this value of current. The low-frequency limit is decreased by approximately 25% when no direct current flows.

**Turns Ratio:** The ratio of turns of the whole primary winding to the whole secondary winding is given in the "Turns Ratio" column of the table.

**Primary Winding:** The 60-cycle inductance of the whole primary as measured with the tabulated value of "Pri. DC" flowing is given in the "L" column of the table. The maximum value of current that may be applied to any part of the primary is stated in the "I Max." column.

**Mounting:** Each transformer is mounted in a standard drawn-steel, wax-filled Model B case. This is illustrated on the opposite page.

**Dimensions:** See the dimensioned drawing, this page, Model B case.

**Net Weight:** 3 pounds.

Type	Use	Frequency Range (Down 2 db) <sup>1</sup>					Primary			Code Word	Price
		Out of (ohms)	Into (ohms)	Pri. DC (ma) <sup>2</sup>	From (cycles)	To (cycles)	Turns Ratio	L <sup>1</sup> (h)	I Max. (ma)		
541-C	P-P Plates to Voice Coil	10,000	4-15	1	30	12,000	35.6 to 1	45	50	TAPER	\$6.00
		4000	4-15	3	25	10,000					
541-D	P-P Plates to Voice Coil	4000	4-16 <sup>3</sup>	3	40	15,000	23.6 (33.3) <sup>3</sup> (47.2) <sup>3</sup> to 1	12	70	TULIP	6.00
		2000	1-12 <sup>3</sup>	3	30	15,000					
541-P	P-P Plates to Line or Mixer	32,000	400-600	0.13	15	18,000	4.4 to 1	75	25	ABIDE	6.00
		20,000	400-600	0.25	25	16,000		70			
		10,000	400-600	0.4	20	12,000		65			
	One <sup>4</sup> Plate to Line, Mixer	16,000	400-600	2.5	30	16,000	30	27	25		
		10,000	400-600	5.0	30	16,000	27				
		5000	400-600	8.0	30	13,000	25				

<sup>1</sup> Data are for whole of tapped windings.

<sup>2</sup> Dc for 10% unbalance, when push-pull connection is used.

<sup>3</sup> Using taps on windings.

<sup>4</sup> Use whole winding, P<sub>1</sub> to plate.

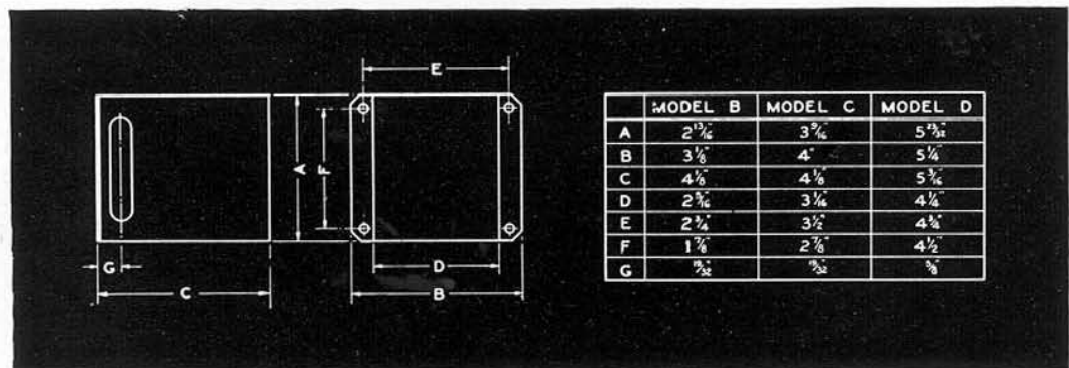

Dimensions for standard General Radio transformer-mounting cases

## TYPE 741 TRANSFORMERS

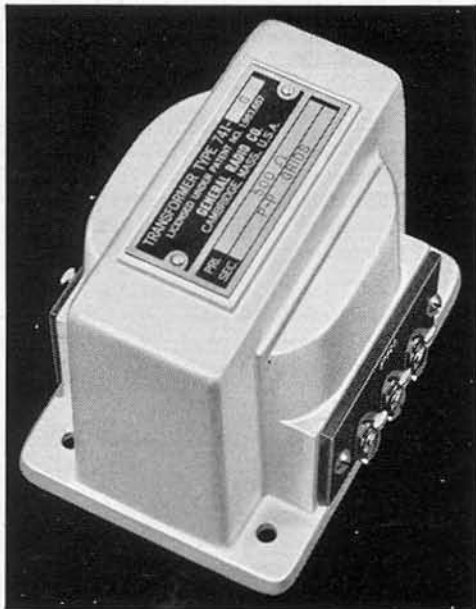

FREQUENCY RANGE

50 TO 200,000

CYCLES PER SECOND

TYPE 741 Transformers are intended for use in vacuum-tube amplifier circuits where a wide range of frequencies must be transmitted. They are useful in many phases of experimental investigation at carrier and low-radio frequencies, such as wide-range audio circuits, facsimile transmission, experimental television, and amplifiers for use with cathode-ray oscillographs.

A high-permeability nickel-iron alloy is used for the core material. Similar alloys have been considerably used for cores where their high permeability is helpful in obtaining wide-frequency-response. It has, however, one characteristic which makes it necessary to handle it carefully in the usual vacuum-tube circuits—magnetic saturation of the core occurs at very low values of ampere turns. One of the important reasons why these wide range transformers must be used in push-pull circuits is to cancel the effect of any direct current flowing in the plate circuits of tubes from which transformers are operated. A current unbalance of 1 or 2 milliamperes between tubes will not affect the magnetic characteristics, but it is essential that the unbalance current does not exceed this value.

The principal feature of these new transformers, and that which requires much attention in their design, is the structure of the coil and the core so that leakage reactance and distributed capacitance are reduced to the lowest possible values. The question of electrical balance between the various sections of the winding is important. This also makes it necessary, in order to obtain the best possible frequency characteristic, that the transformers be worked in balanced or push-pull circuits.

Three standard models are available:

- (1) TYPE 741-G, 500–600 ohm line to push-pull grids.
- (2) TYPE 741-J, interstage push-pull plates to push-pull grids.
- (3) TYPE 741-P, push-pull plates to 500–600-ohm line.

All models are housed in cast-aluminum cases. The cases provide shielding at audio frequencies and are particularly useful in reducing inductive feed-back which may cause "singing." The cases are also excellent shields against other high-frequency disturbances such as the usual lab-

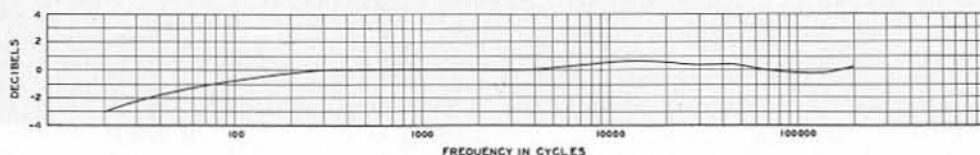

Frequency characteristic TYPE 741-G Line-to-Grid Transformer. Voltage step-up ratio 1:6.4



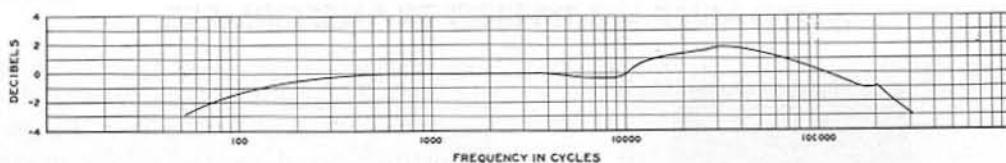

Frequency characteristic TYPE 741-J Interstage Transformer. Voltage ratio 1:1

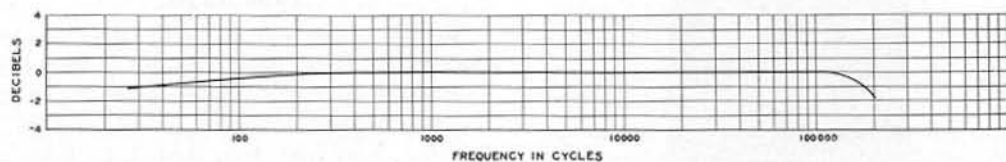

Frequency characteristic TYPE 741-P Plate-to-Line Transformer. Voltage step-down ratio 6.35:1

oratory noises caused by circuit breakers, switches, etc., all of which are bothersome, particularly when a wide frequency range is being used. Cast iron is a somewhat more effective shield at 40 to 180 cycles than aluminum. Such cases can be provided on special order, but generally it has been found that power-line hum interference is less serious than that produced by other sources.

## SPECIFICATIONS

**Frequency Range:** 50 to 200,000 cycles per second. Frequency characteristics for each model are shown in the accompanying diagrams.

**Circuit:** All models are for use in push-pull circuits. Line-to-grid, interstage, and plate-to-line models are available. The latter are intended for use with tubes having plate impedances of about 10,000 ohms.

**Turns Ratio:** See price list.

**Core:** A shell-type core is used. The core material is "A-Metal."

**Terminals:** Screw-type terminals with soldering lugs are provided each.

**Mounting:** The transformer is mounted in a cast aluminum case. The base has four mounting holes.

**Dimensions:**  $3\frac{3}{8} \times 3\frac{7}{8} \times$  (height)  $3\frac{7}{16}$  inches, overall.

**Net Weight:** 3 pounds.

Type	Turns Ratio	Use	Code Word	Price
741-G	1 to 6.4	500-ohm line to p. p. grids	WIDTRANANT	\$22.50
741-J	1 to 1	interstage	WIDTRANBOY	22.50
741-P	6.35 to 1	p. p. plates to 500-ohm line	WIDTRANCAT	22.50

PATENT NOTICE. See Note 25, page v.

## IMPEDANCE-MATCHING TRANSFORMERS

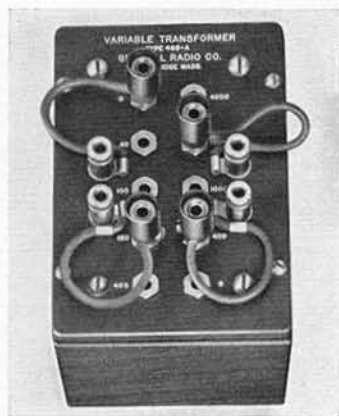

TYPE 666-A

All General Radio transformers may be used as impedance-matching transformers. They will transform impedances in the square of their turns ratio which will be found in the "Turns Ratio" column of the tables. They may be used in either direction, that is, as step-up or step-down impedance-matching transformers. The frequency ranges given in the tables hold for this use of the transformers as well, and the "Pri. DC" limit still holds. If the "secondary" winding is connected to the source and the frequency range is to be maintained, the number of aiding d-c milliampereturns for the whole transformer must not exceed the value it has under rated conditions.

Type 585-R

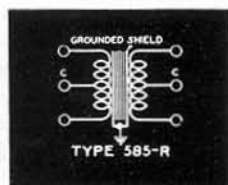

The TYPE 585-R Transformer is a high-quality, unity-ratio, circuit isolator for use between transmission lines of from 500 to 700 ohms impedance. The primary and secondary windings are thoroughly shielded from each other to minimize electrostatic coupling with the result that on balanced lines the parallel component of interference energy is filtered from the signal. The provision of center-tapped windings allows interchangeable use between balanced and unbalanced systems and also for their interconnection.

In bridge measurements the use of this transformer makes the bridge balance independent of electrical or locational changes in the detector circuit, assuring greater accuracy and ease of balance.

Type 585-C

For line-interconnection and mixer problems the TYPE 585-C Transformer presents the facilities of an impedance changing device with impedance transformation ratios of 1 to 10, 1 to 2.5, 1 to 1.56, 1 to 0.64, 1 to 0.25, and 1 to 0.10, allowing the transformations shown in the table to be taken in either direction. The desired ratios are obtained as shown in the diagrams at the foot of the opposite page. The terminals are so arranged that only adjacent ones need be strapped.

## LABORATORY TRANSFORMERS

The following two transformers are not to be used for impedance matching in quality communication or program circuits. They are valuable in alternating-current measurements not dependent on relative response at widely separated frequencies.

Type 666-A

Where it is desired to have the impedance ratio easily adjustable over a wide range by means of a plug arrangement at the expense of attenuation of the high and low frequencies, the TYPE 666-A Variable Transformer is recommended. Primarily a laboratory instrument, this transformer is provided with jack-top binding posts to receive a TYPE 274 Plug and has multi-tapped windings with the included turns from one end marked plainly on the panel. Any portions of the windings may be used; not only is the impedance ratio adjustable but approximate ratios may be obtained through different arrangements, allowing a choice of a favorable value of primary inductance.

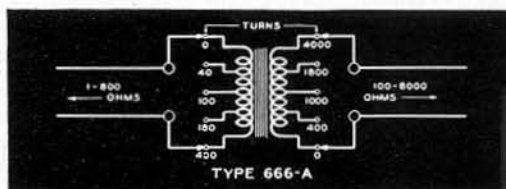

# AUDIO-FREQUENCY TRANSFORMERS

## SPECIFICATIONS

**Use:** The most common uses of the impedance-matching transformers are suggested in the second column of the following table. The associated data are chosen for conditions that will most frequently be met in the suggested uses.

**Frequency Range:** The table gives the frequency range over which the voltage ratio is less than 2 db below its value on the flat portion of the characteristic. This range holds for operation "Out of" a source and "Into" a load having the impedances shown in columns three and four. For intermediate values of source and load impedances the frequency range may be found by direct interpolation.

**Turns Ratio:** The turns ratio of the whole primary winding to the whole of the secondary winding is given in the "Turns Ratio" column of the table. For the adjustable-ratio transformer, TYPE 666-A, the

turns included between the tap and one end are shown in the diagram at the foot of the opposite page.

**Primary Winding (Higher Impedance Winding):** The nominal 60-cycle inductance of the whole primary is given in the "L" column of table. The maximum current that may be applied to any part of the windings is stated under "I Max."

**Mounting:** TYPES 585-C and 585-R are mounted in standard drawn-steel, wax-filled Model B cases. For TYPE 666-A see illustration.

**Dimensions:** For TYPES 585-C and 585-R see dimensioned drawing, Model B case. TYPE 666-A: 3½ x 4½ x 5 in.

**Net Weight:** TYPES 585-C and 585-R, 3 pounds; TYPE 666-A, 3½ pounds.

Type	Use	Frequency Range (Down 2 db) <sup>1</sup>				Turns <sup>1</sup> Ratio	Fig.	Primary		Code Word	Price
		Out of (ohms)	Into (ohms)	From (cycles)	To (cycles)			L <sup>1</sup> (h)	I Max. (ma)		
585-C	Line, Mixer to Line, Mixer	400-600	150-250	25	10,000	1.6	A	6	50	ABODE	\$6.00
		400-600	40-60	25	11,000	(3.2) <sup>2</sup>	B		(pri.)		
		100-150	150-250	25	11,000	(0.8) <sup>2</sup>	C		100		
		100-150	40-60	25	12,000	to 1	D		(sec.)		
585-R	Line, Mixer to Line, Mixer	800	800	30	16,000	1	3	75	ABOMA	6.00	
		400	400	25	18,000	to 1		(pri. & sec.)			
666-A	General Purpose Matching	100-8000 <sup>2</sup>	1-800 <sup>2</sup>			1 to 10		60 (pri.) 150 (sec.)	ABOON	12.50	

<sup>1</sup>Data are for whole of split or tapped windings.

<sup>2</sup>Using taps on windings.

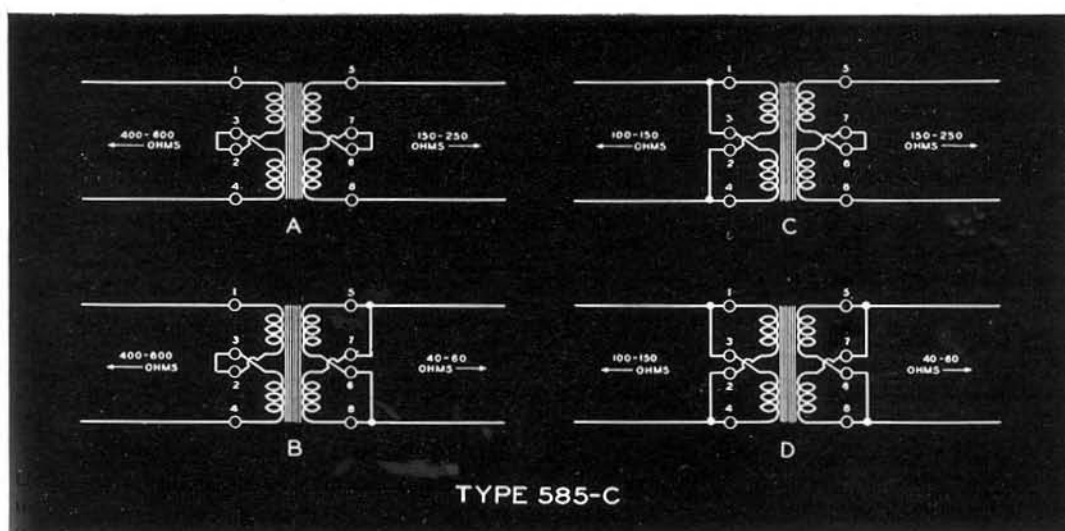

## TYPE 480 RELAY RACK

This rack is intended for mounting standard 19-inch panels whose heights are integral multiples of  $1\frac{3}{4}$  inches. Racks of this type have been in use in telephone plants for many years, and they are fast becoming standard in laboratories for mounting apparatus. Two sizes are available.

Attention is also directed to the TYPE 660-A Rack described on opposite page.

### SPECIFICATIONS

**Construction:** Steel frame with welded joints. Both models have provision for bolting them to the floor or table, but they are stable enough to stand without fastening for all ordinary service.

**Drilling:** Standard drilling for 19-inch relay-rack panels is employed. Holes are tapped and cleaned for a 10-32 panel-mounting screw.

**Accessories:** Panel-mounting screws, panel-protecting washers, and bridle rings for cabled wiring are supplied.

**Dimensions:** TYPE 480-A: Frame, (height)  $69\frac{1}{8}$  x (width) 20 x (depth) 3 inches, over-all. Base, (width) 20 x (depth) 15 inches. Panel-mounting space, 63 inches or 36 "rack units."

TYPE 480-B: Frame, (height) 44 x (width) 20 x (depth)  $1\frac{1}{2}$  inches, over-all. Base, (width) 20 x (depth) 15 inches. Panel-mounting space,  $43\frac{3}{4}$  inches or 25 "rack units."

**Net Weight:** TYPE 480-A, 94 pounds. TYPE 480-B, 20 pounds.

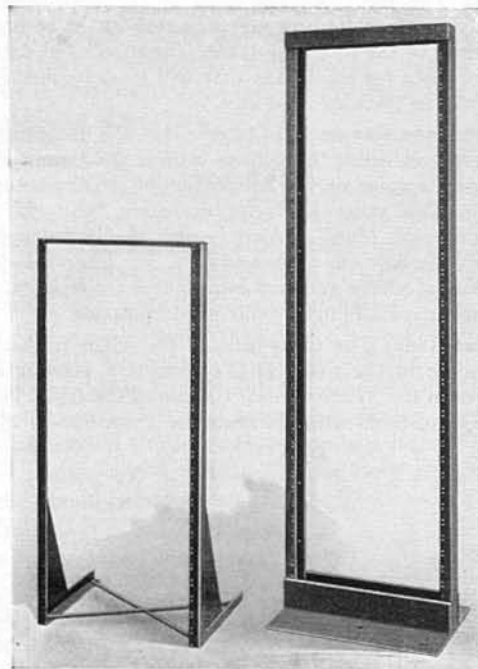

Left: TYPE 480-B; right: TYPE 480-A

Type	Panel Space		Code	Price
	Inches	Rack Units	Word	
480-A	63	36	NEEDY	\$40.00
480-B	$43\frac{3}{4}$	25	NEGRO	15.00

### NOTES ON LAYING OUT RELAY-RACK PANELS

1. Make panel height a multiple of  $1\frac{3}{4}$  inches less  $\frac{1}{32}$  inch for clearances.

2. Both top and bottom edges of a properly mounted panel will, neglecting clearances, always fall half way between a pair of holes spaced  $\frac{1}{2}$  inch apart on the rack.

3. It is seldom necessary to cut all the possible mounting-screw slots in a panel, but it can be done if desired.

4. Any panel laid out to fit the rack will also fit if the panel is turned end-for-end or back-for-front.

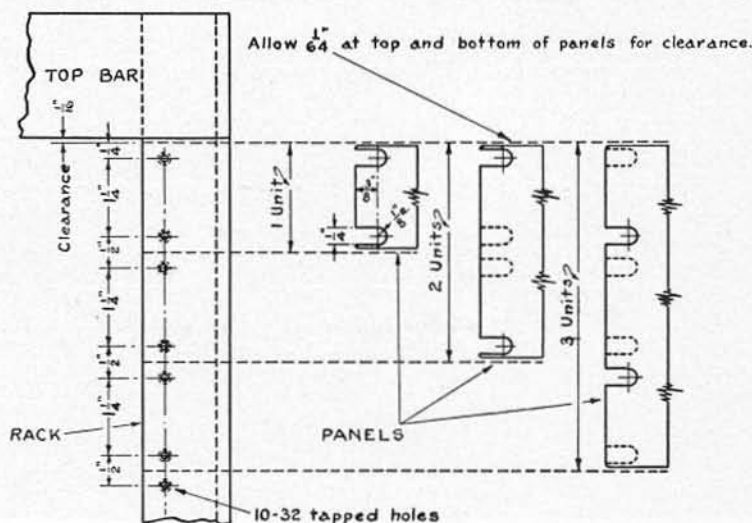

Note: Clearance between vertical supports on rack  $17\frac{1}{2}$  inches.



## UNIT PANELS

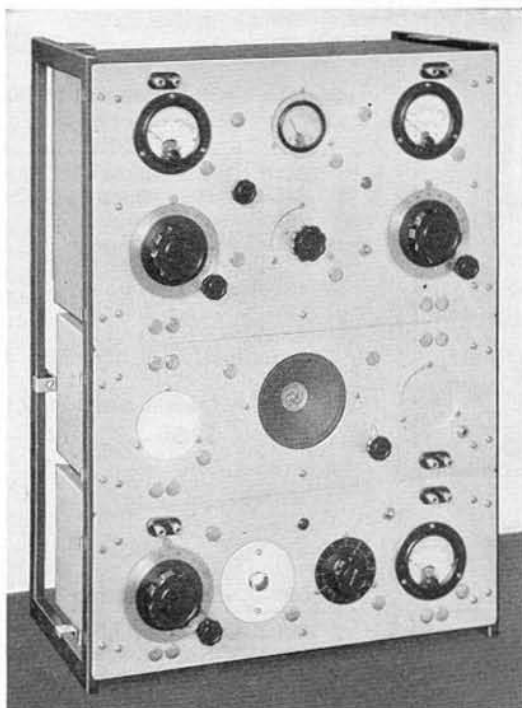

An assembly of TYPE 661 Unit Panel equipment on a TYPE 660 Rack

General Radio has recently developed a series of unit panels designed to facilitate the fabrication of experimental and semi-permanent assemblies. All parts are interchangeable. Layout changes can be made at any time without disfiguring the panel, and a unit is easily disassembled for conversion into an entirely different instrument.

The parts required for a complete metal box are a base, two end plates, a dust cover, and a panel (with the accessories accompanying it). All principal parts are made of Eraydo, a non-magnetic, non-corrosive alloy of copper, silver, and zinc, which is stronger than materials commonly used for such parts. One face is satin finished and coated with clear lacquer.

The drawings on the next page show to scale the location of all holes. Each panel has several  $2\frac{7}{8}$ -inch diameter holes symmetrically placed, around each of which are three small holes for mounting the standard bakelite (Navy type) meter case, or for fastening mounting discs to the panel. Adjacent to each large panel hole is a  $\frac{1}{2}$ -inch hole for the slow-motion mechanism of a 4-inch, TYPE 703 Dial.

At both top and bottom near either end are located pairs of  $\frac{1}{2}$ -inch holes on  $\frac{3}{4}$ -inch centers to fit TYPE 274 Panel Insulators with TYPE 138-VD Binding Posts for input and output connections. Other holes are intended for single-hole-mounting parts such as rheostats, telephone jacks, etc. Bushings for reducing the diameter of the holes to  $\frac{1}{16}$  inch or  $\frac{3}{8}$  inch are furnished with the panel. Unused holes are plugged with TYPE 661-P4 Snap Buttons.

One panel is furnished with a 5-inch, permanent-magnet dynamic loudspeaker, the input impedance of which is 3000 ohms.

Four types of mounting discs are available. TYPE 661-P1 Blank Mounting Discs are used either to cover the large panel holes not in use, or to mount parts other than those manufactured by General Radio. The center of each is pricked on the reverse to facilitate layout.

The TYPE 661-P2 3-Hole Mounting Discs have three small holes drilled on a  $\frac{1}{8}$ -inch radius for mounting General Radio parts having the standard 3-hole mounting. Short spacers which provide clearance for the disc-mounting screws are furnished. Discs can be mounted at  $30^\circ$  angles around  $360^\circ$ .

The TYPE 661-P3 Adapter Disc has a  $2\frac{1}{8}$ -inch hole and is designed to mount meters such as the Weston type 506.

Dust covers for the two sizes of end plates are available. They fit tightly and slide on from the rear so that they may be removed when the panel assemblies are mounted one above another on a relay rack.

*All prices and illustrations on next two pages*

## TYPE 660-A UNIVERSAL RACK

This is the rack shown in the cut on this page. It consists of two rectangular steel frames which mount parallel to each other. These frames may be screwed to the bench, or they may be fastened to the bench and wall by the four clamps supplied with each rack.

TYPE 661-P5 Panel Clamps will clamp a panel to the rack in any desired position. Four

of these are supplied with each unit panel, but none are supplied with the rack. The rack can be used for panels of any width.

The height of the TYPE 660-A Rack is  $26\frac{1}{2}$  inches (fifteen  $1\frac{3}{4}$ -inch rack units).

Type	Rack Units	Code Word	Price
660-A	15	NINNY	\$6.00

# PARTS AND ACCESSORIES

## UNIT PANELS AND ACCESSORIES (Drawings 1/6th Actual Size)

### 19 x 12-INCH UNIT PANELS

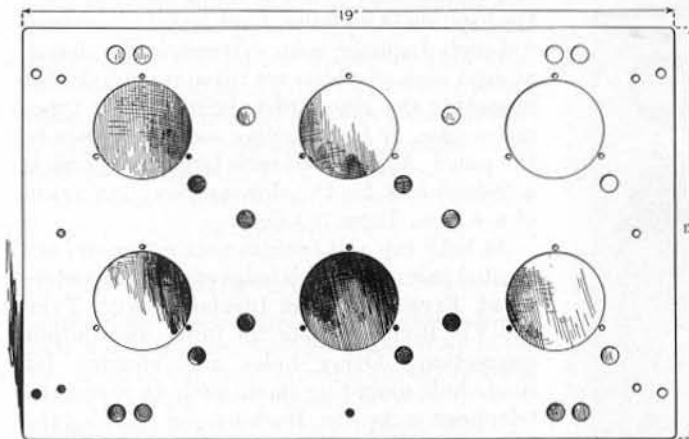

#### Type 661-A, with accessories, \$6.00

Number Supplied	Type	Description
3	661-P1	Blank Mounting Discs
3	661-P2	3-Hole Mounting Discs
20	661-P4	Snap Buttons
2 pr.	661-P5	Panel Clamps
12	661-P6	Mounting Spacers
6	661-P8	3/8-inch Bushing
6	661-P9	1/16-inch Bushing
25	Machine screws and nuts (for base, ends, and discs)	

#### Type 661-AX, blank panel only, \$2.50

### 19 x 7-INCH UNIT PANELS

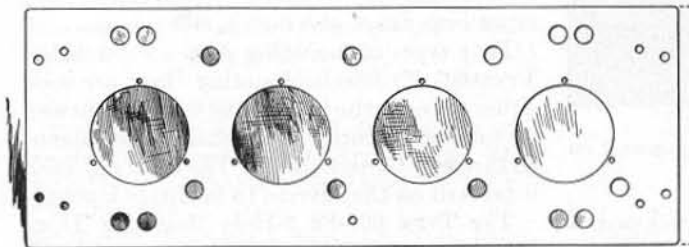

#### Type 661-B, with accessories, \$4.00

2	661-P1	Blank Mounting Discs
2	661-P2	3-Hole Mounting Discs
15	661-P4	Snap Buttons
2 pr.	661-P5	Panel Clamps
9	661-P6	Mounting Spacers
4	661-P8	3/8-inch Bushing
4	661-P9	1/16-inch Bushing
17	Machine screws and nuts (for base, ends, and discs)	

#### Type 661-BX, blank panel only, \$1.75

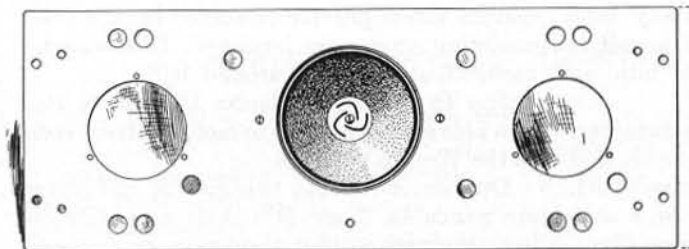

#### Type 661-C, with accessories, \$9.00

1	661-P1	Blank Mounting Disc
1	661-P2	3-Hole Mounting Disc
13	661-P4	Snap Buttons
2 pr.	661-P5	Panel Clamps
6	661-P6	Mounting Spacers
4	661-P8	3/8-inch Bushing
4	661-P9	1/16-inch Bushing
13	Machine screws and nuts (for base, ends, and discs)	
1	5-inch Dynamic Speaker and Clamp	

## ACCESSORIES (1/3rd Actual Size)

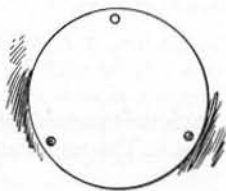

Type 661-P1  
Blank Mounting Disc

For use as blank cover or "drill your own." Center prick-punched for easy layout. \$0.15 each.

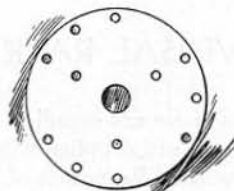

Type 661-P2  
3-Hole Mounting Disc

For 3-hole mounting, 120° apart on 3/8-inch radius. 12 possible positions. \$0.20 each.

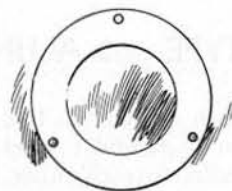

Type 661-P3  
Adapter Disc

For 2 1/16-inch meters (e.g., Weston 506). \$0.20 each.



Type 661-P11  
Cover Plate

For use with TYPE 177-B Inductor Form and TYPE 177-K Inductor Shield. \$0.20 each.

## ENDS, BASES, DUST COVERS (Drawings 1/6th Actual Size)

### Type 661-K End- and Base-Plate Assembly

For 19 x 12-inch Panels  
\$5.00

Base plate can be mounted in any one of four positions. Machine screws and spacing pillars supplied. Order panel (shown dotted) and dust cover separately.

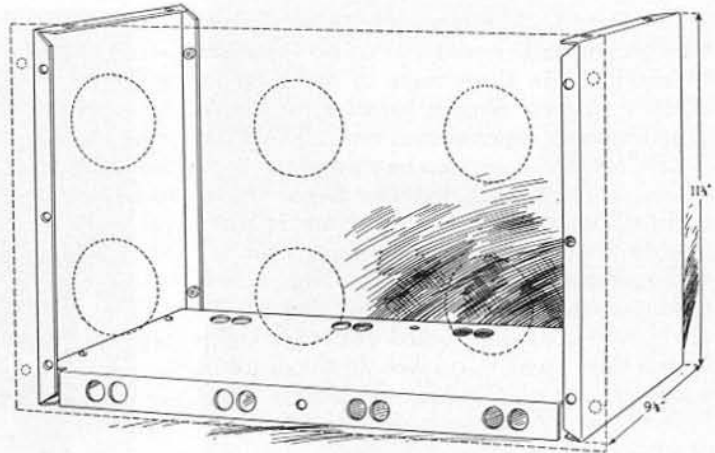

### Type 661-L End- and Base-Plate Assembly

For 19 x 7-inch Panels  
\$4.00

Base plate can be mounted in any one of four positions. Machine screws and spacing pillars supplied. Order panel (shown dotted) and dust cover separately.

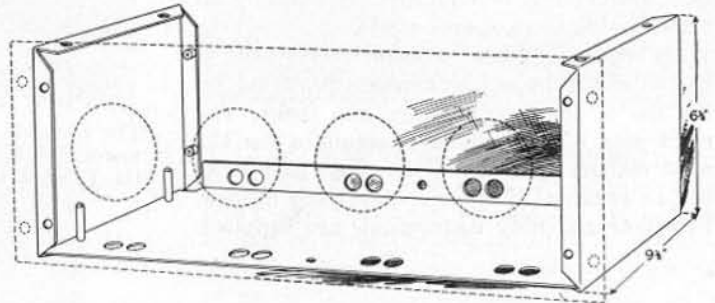

### Type 661-R Dust Cover

For 12-inch Panels  
\$2.00

### Type 661-S Dust Cover

For 7-inch Panels  
\$1.50

Fit closely. Can be attached and removed when panels are mounted one above another on a rack. Machine screws for back supplied.

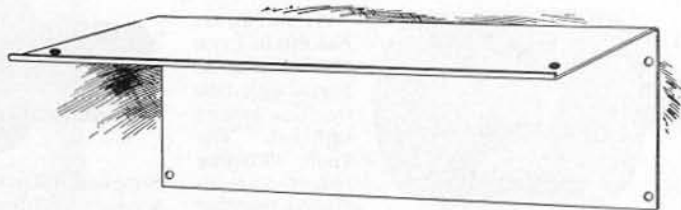

## ACCESSORIES (Shown Actual Size)

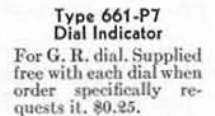
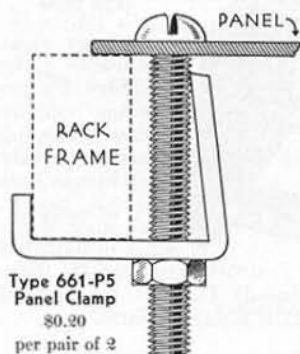

PLUG-IN INDUCTORS FOR UNIT PANELS

The three basic components shown below, together with a TYPE 661-P11 Cover Plate can be assembled in three ways to make up an effective shielded plug-in inductor for use in high-frequency experimental work. The TYPE 177-B Inductor Form can be used alone or, if desired, a TYPE 177-K Inductor Shield can be attached to make one integral unit. Then, when a shielded inductor is required for use with unit-panel assemblies, the cover plate is added, as shown in the photograph below. The shield base is securely locked to the shield top by the three bayonet catches. In the center is a threaded rod which engages a threaded insert in the TYPE 661-P10 Jack Base and draws the cover plate firmly against the panel.

The TYPE 661-P10 Jack Base can be used behind the panel or mounted horizontally on a shelf using short spacer studs.

An important feature in short-wave work is the excellent noise-free contact provided by the use of spring-type plugs and jacks. The eight sets of contacts are adequate for the most elaborate circuit. Both plugs and jacks can be removed if fewer contacts are needed. Complete assembly instructions are supplied.

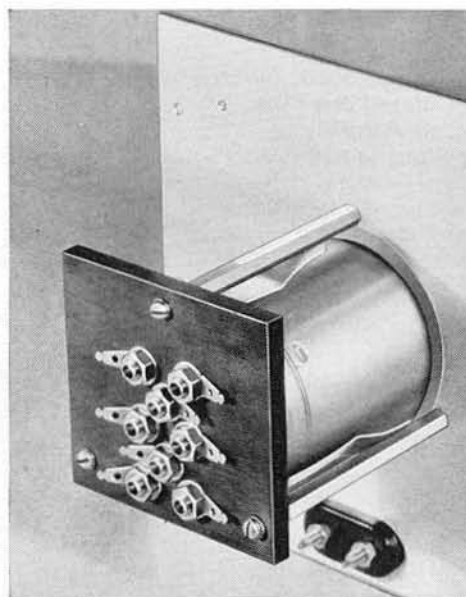

The complete shielded inductor mounts in this manner on a unit panel. The three springs on the TYPE 661-P10 Jack Base guide the inductor into place

Type 177-K Inductor Shield



Aluminum. Fastens to TYPE 177-B Inductor Form with two machine screws supplied. The knob, clamping rod, etc., are included together

with complete assembly instructions.

Code Word: INDUCTKEMP

Price: \$0.75



Type 177-B Inductor Form

Can be used alone, with shield, or with shield and cover plate for unit-panel mounting. See photographs.

Supplied with eight removable plugs (with lock-washers and lugs). Winding form: 1 1/4 inches (diameter), 1 3/4 inches (length). Moulded bakelite.

Code Word: INDUCTBOAT

Price: \$0.85

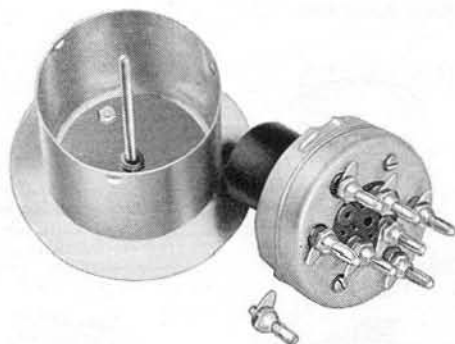

A shielded inductor-form assembly, made up from a TYPE 177-B Inductor Form, a TYPE 177-K Inductor Shield, and a TYPE 661-P11 Cover Plate.

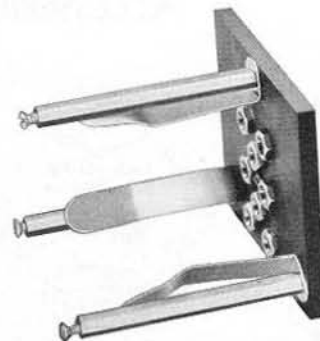

Type 661-P10 Jack Base

Includes eight removable jacks and lugs. Unique locating device makes plugging in coils extremely easy. Spacer bars fit unit panels. Base may, if desired, be mounted on shelf base (short spacers not included). Designed for shielded or unshielded TYPE 177-B Inductor Form.

Code Word: UNIPANBASE

Price: \$1.50



**TYPE 519-A DIAL LENS**

(See Illustration on Page 152)

This consists of a small lens with an adjustable holder to mount on a panel over the dial indicator, and makes possible the reading of a dial (especially those shown on the next page) to a high degree of precision. When not in use the arm can be swung out of the way and the lens pushed against the panel to minimize space requirements. When in use the lens is held in proper position by a detent device.

**SPECIFICATIONS**

**Dimensions:** (Height above panel) 2 x (width) 1 1/8 x (length or radius) 2 3/8 inches.

Focal length, 1 1/4 inches.

**Mounting:** One 3/8-inch hole required for mounting.

**Net Weight:** 2 ounces.

Type	Code Word	Price
519-A	ABASH	\$1.75

**TYPE 520-A DIAL LOCK**

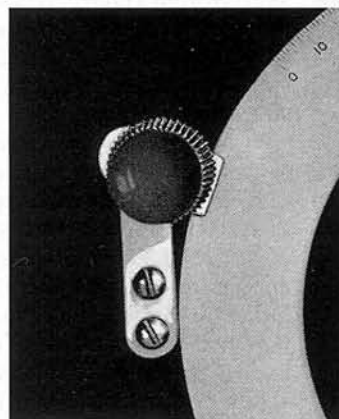

Any General Radio dial may be firmly clamped in any position by means of the TYPE 520-A Dial Lock which holds the edge of the dial in a vise-like grip, without exerting appreciable force on the shaft on which the dial is mounted. The lock does not alter the dial setting and may be unclamped by loosening the knurled knob when it is desired to change dial to a new setting.

**SPECIFICATIONS**

**Dimensions:** (Length) 2 x (width) 1 x (height) 1 1/2 inches over-all. Height above panel, 1 inch.

**Mounting:** Two No. 28 holes, 3/8 inch apart, are required for mounting.

**Net Weight:** 1 1/2 ounces.

Type	Code Word	Price
520-A	ABATE	\$0.75

**TYPE 677 INDUCTOR FORM**

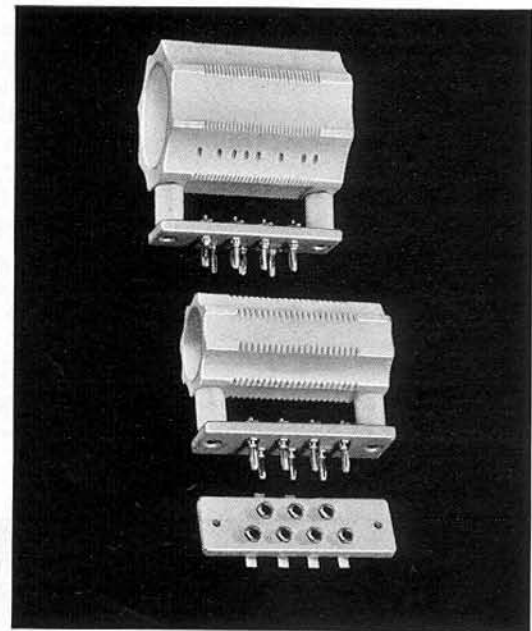

These coil forms are made of moulded porcelain in two convenient sizes. The eight notched ribs provide permanent winding spacing while the series of small holes gives adequate anchorage. Taps and separate windings up to a total of seven terminals are accommodated by a matched plug-in base and jack, separately available.

For complete assembly two TYPE 677-P1 Coil Form Spacers, with which are included the necessary machine screws, nuts, and lead washers, are required. These spacers may also be used to support the jack plate.

The V-cut threads permit use of wire size up to #10 B. & S., and extend over three inches.

**SPECIFICATIONS**

**Dimensions:** Length, all units, 4 5/8 inches. Diameter, TYPE 677-U, 2 1/2 inches; TYPE 677-Y, 3 7/8 inches. Width, TYPES 678-P, 678-J, 1 1/2 inches. Height, TYPE 677-P1, 1 inch.

**Net Weight:** TYPE 677-U, 10 ounces. TYPE 677-P1 (per pair), 2 ounces. TYPE 677-P, 4 ounces. TYPE 677-J, 4 ounces. TYPE 677-Y, 1 5/8 pounds.

Type	Description	Code Word	Price
677-U	Coil Form	MIMIC	\$0.50
677-Y	Coil Form	MISER	.75
677-P1	Spacer (2 req'd)	MINIM	.30 (pair)
678-P	Base with 7 Plugs	MINOR	.70
678-J	Base with 7 Jacks	MINNY	.65

# PARTS AND ACCESSORIES

## TYPES 704 AND 706 PRECISION DIALS

These are high-grade precision dials, with scales individually engraved on an automatic self-indexing engraving machine in fine, radial, and accurately located lines. The dial scale and the slow-motion knob rotate in the same direction.

The accuracy of the engraving and the precision of setting obtainable justify the use of a TYPE 519-A Dial Lens.

Backlash has been eliminated in the construction of these long-scale dials by setting the scale permanently and securely on the main shaft which thus has its angular position accurately indicated. The tension of the friction drive is adjustable to suit the load and the preference of the operator, and the position of the friction drive shaft may be adjusted to compensate for errors in the centering of the main shaft in the center hole by means of an eccentric bushing.

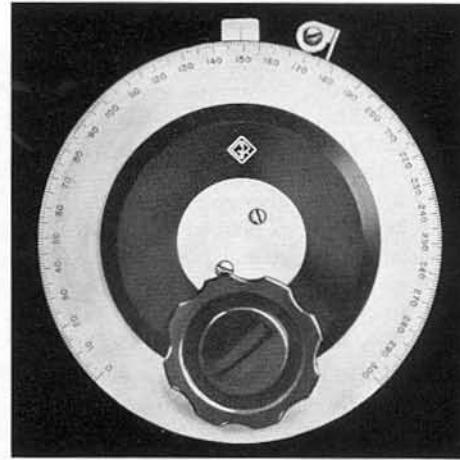

TYPE 704-D

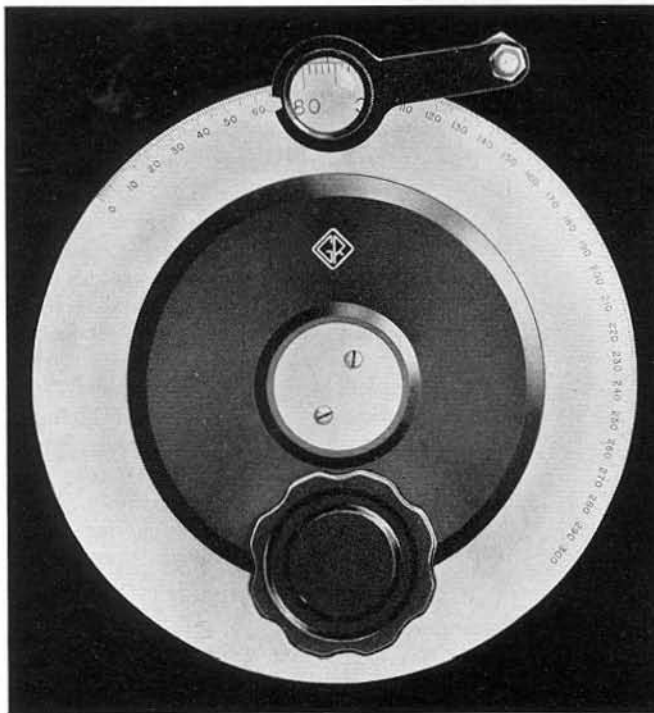

TYPE 706-C

These dials are secured to their shafts through the use of two set-screws separated by 120° and are supplied bored to receive a 3/8-inch shaft. For use with a 1/4-inch shaft, a split collar bushing is provided which securely grips the shaft throughout one inch of its length, averting all possibility of slipping.

Settings of these dials may consistently be duplicated to one-fifth of a division, allowing an accuracy of resetting, for the TYPE 706-D, of better than 0.05%. Parallax is eliminated through the use of an indicator which always remains flush with the surface of the dial, and at the same time absorbs the slight eccentricities of the main shaft through the flexibility of its mounting arm.

Only one additional hole in the panel is required for mounting; the drilling template furnished enables it to be accurately located.

The dial indicator is supplied.

### ● 4-INCH DIAMETER PRECISION DIALS

Type	Dial		Friction- Drive Ratio	Net Weight	Code Word	Price
	Arc	Divisions				
704-C	180°	200	1:6	9 ounces	DABBY	\$7.50
704-D	270°	300	1:6	9 ounces	DAIRY	7.50

### ● 6-INCH DIAMETER PRECISION DIALS

Type	Dial		Friction- Drive Ratio	Net Weight	Code Word	Price
	Arc	Divisions				
706-C	180°	300	1:8	1 pound	DASHY	\$8.00
706-D	270°	450	1:8	1 pound	DATUM	8.00

PATENT NOTICE. See Note 17, page v.

FRICION-DRIVE AND DIRECT-DRIVE DIALS

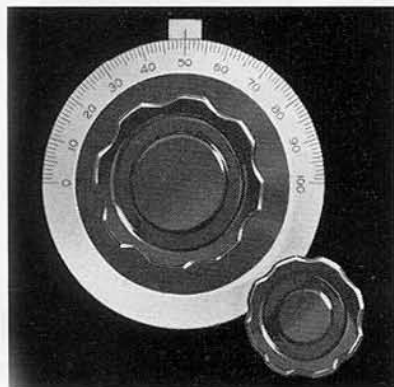

Types 702-A and 702-F

The dials described here have photo-etched, nickel-silver scales and use the fluted bakelite knob described on page 155.

Three diameters are available either with or without the friction drive. An indicator and drilling template are supplied.

All dials are insulated from the shaft.

See next page for 3 1/4-inch dials.

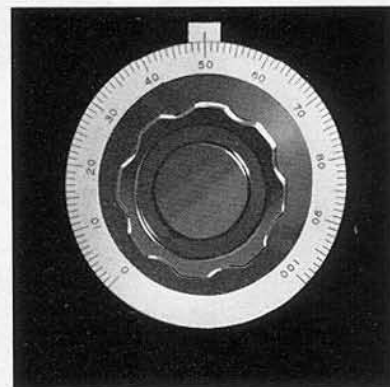

Types 710-B and 710-G

● 2 3/4-INCH DIAMETER — TYPE 702 FRICTION-DRIVE DIALS\*

Type	Shaft		Dial		Friction-Drive Ratio	Net Weight	Code Word	Price
	Diameter	Arc	Divisions	Arc				
702-A	1/4 in.	180°	100	180°	1:3.3	4 oz.	DIACK	\$1.75
702-B	1/4 in.	270°	100	270°	1:3.3	4 oz.	DIBOG	1.75
702-F	3/8 in.	180°	100	180°	1:3.3	4 oz.	DIFAG	1.75
702-G	3/8 in.	270°	100	270°	1:3.3	4 oz.	DIGOD	1.75

● 2 3/4-INCH DIAMETER — TYPE 710 DIRECT-DRIVE DIALS

710-A	1/4 in.	180°	100	180°	.....	2 1/2 oz.	DIALY	\$1.00
710-B	1/4 in.	270°	100	270°	.....	2 1/2 oz.	DIBIN	1.00
710-G	3/8 in.	270°	100	270°	.....	2 1/2 oz.	DIGUT	1.00

● 4-INCH DIAMETER — TYPE 703 FRICTION-DRIVE DIALS\*

703-A	1/4 in.	180°	100	180°	1:5	8 oz.	DIANT	\$2.00
703-B	1/4 in.	270°	200	270°	1:5	8 oz.	DIBUT	2.00
703-F	3/8 in.	180°	100	180°	1:5	8 oz.	DIFUN	2.00
703-G	3/8 in.	270°	200	270°	1:5	8 oz.	DIGUM	2.00

● 4-INCH DIAMETER — TYPE 717 DIRECT-DRIVE DIALS

717-A	1/4 in.	180°	100	180°	.....	5 oz.	DIARM	\$1.50
717-B	1/4 in.	270°	200	270°	.....	5 oz.	DIBAR	1.50
717-F	3/8 in.	180°	100	180°	.....	5 oz.	DIFIT	1.50
717-G	3/8 in.	270°	200	270°	.....	5 oz.	DIGAR	1.50

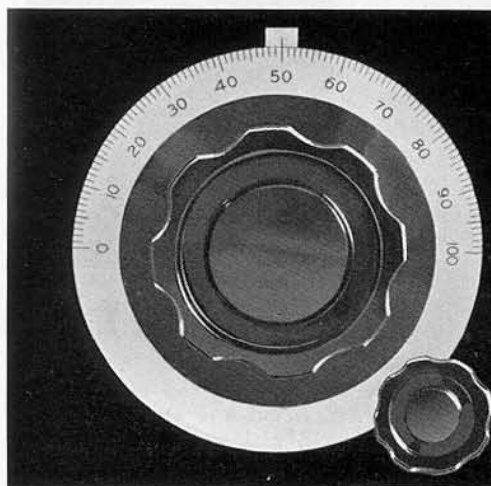

Types 703-A and 703-F

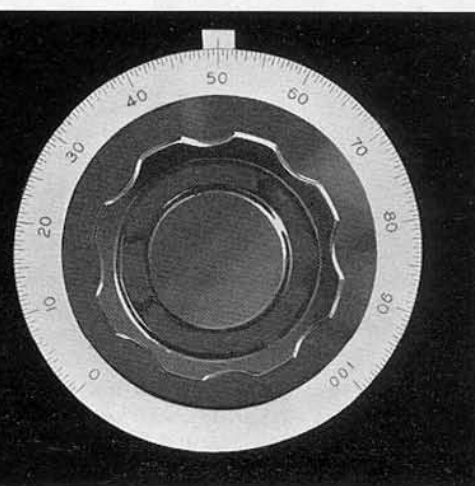

Types 717-B and 717-G

All illustrations 1/2 actual size

\*PATENT NOTICE. See Note 17, page v.

# PARTS AND ACCESSORIES

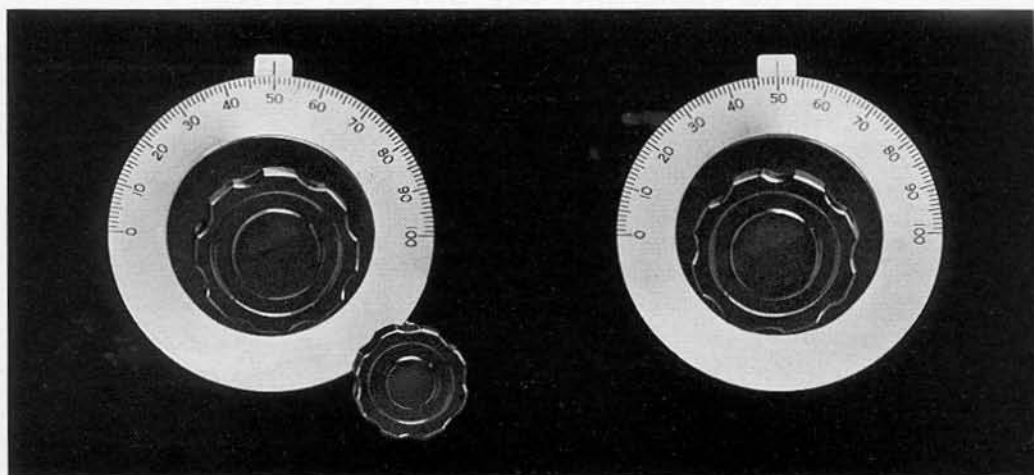

Type 705

Type 712

● 3/4-INCH DIAMETER — TYPE 705 FRICTION-DRIVE DIALS

Type	Shaft Diameter	Dial		Friction-Drive Ratio	Net Weight	Code Word	Price
		Arc	Divisions				
705-A	1/4 in.	180°	100	1:4	4 1/2 oz.	DIARK	\$1.75
705-F	3/8 in.	180°	100	1:4	4 1/2 oz.	DIFAL	1.75

PATENT NOTICE. See Note 17, page v.

● 3/4-INCH DIAMETER — TYPE 712 DIRECT-DRIVE DIALS

Type	Shaft Diameter	Dial		Friction-Drive Ratio	Net Weight	Code Word	Price
		Arc	Divisions				
712-A	1/4 in.	180°	100	.....	4 1/2 oz.	DIAPE	\$1.25
712-F	3/8 in.	180°	100	.....	4 1/2 oz.	DIFAR	1.25

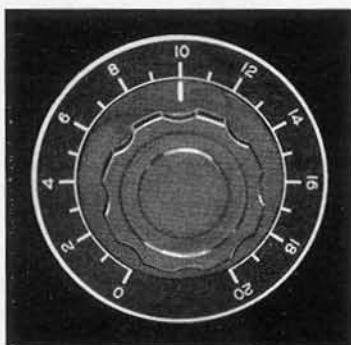

Type 318-A

A 3-inch diameter plate for use with a 1 5/8-inch knob, either pointer or skirt, and with any rheostat-potentiometer having standard 3-hole mounting. Marked with 20 divisions around 298°.

Code Word: DEVIL

Price: \$0.35

## DIAL PLATES

These two dial plates have photo-etched scales with raised nickel-silver graduations on a flat black background. Each can be attached to the panel with the same screws which hold the rheostat-potentiometer with which the dial plate is used.

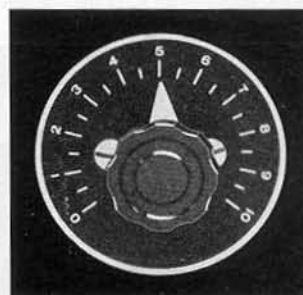

Type 522-A

A 2 1/2-inch diameter plate for use with a TYPE 637-A Knob and a TYPE 301-A or 410-A Rheostat-Potentiometer. Marked with 20 divisions around 254°.

Code Word: DOGMA

Price: \$0.35



**TYPE 637 FLUTED KNOBS**

The moulded bakelite knobs in this type series are now used on all new General Radio apparatus. They were chosen from among dozens of preliminary designs as the ones best suited to the requirements of measuring instruments. The smoothed fluted knurling

affords a positive, cramp-free grip for the most delicate adjustments.

The white pointers are made of non-conducting material, and they can be pried off when knobs alone are required. Each knob has two set screws to insure permanence of setting.

**1 1/8-INCH DIAMETER—WITH POINTER**

Type	Shaft	Net Weight	Code Word	Unit	Package
	Diameter	Ounces		Price	of 10
637-A	1/4 inch	1/2	NURLNOBANT	\$0.30	\$2.10
637-B	3/8 inch	1/2	NURLNOBBOY	.35	2.35



**1 5/8-INCH DIAMETER—WITH POINTER**

Type	Shaft	Net Weight	Code Word	Unit	Package
	Diameter	Ounces		Price	of 10
637-G	1/4 inch	1	NURLNOBGUN	\$0.35	\$2.35
637-H	3/8 inch	1	NURLNOBHAT	.35	2.35



**1 5/8-INCH DIAMETER—WITH SKIRT**

Type	Shaft	Net Weight	Code Word	Unit	Package
	Diameter	Ounces		Price	of 10
637-J	1/4 inch	2	NURLNOBJIM	\$0.40	\$2.75
637-K	3/8 inch	2	NURLNOBKOP	.45	3.25

(Diameter of skirt, 2 1/16 inches)

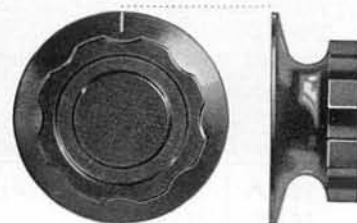

**2 3/8-INCH DIAMETER—WITH POINTER**

Type	Shaft	Net Weight	Code Word	Unit	Package
	Diameter	Ounces		Price	of 10
637-P	1/4 inch	3	NURLNOBPIG	\$0.50	\$3.75
637-Q	3/8 inch	3	NURLNOBQUO	.50	3.75

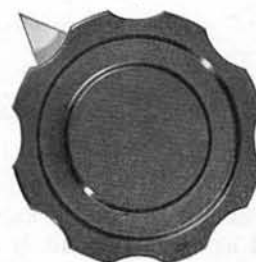

**2 3/8-INCH DIAMETER—WITH SKIRT**

Type	Shaft	Net Weight	Code Word	Unit	Package
	Diameter	Ounces		Price	of 10
637-R	1/4 inch	4	NURLNOBRAM	\$0.50	\$3.75
637-S	3/8 inch	4	NURLNOBSUM	.50	3.75

(Diameter of skirt, 3 inches)

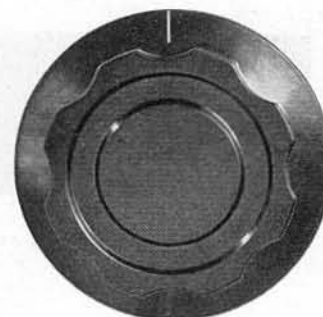

**TYPE 202 SWITCH KNOB**

This is the bakelite knob that is used on our resistance boxes and decade condensers because it enables the operator to estimate the value of a setting by his sense of touch. The pointer is of nickel-plated brass. It is not insulated from the shaft.

Type	Shaft	Net Weight	Code Word	Unit	Package
	Diameter	Ounces		Price	of 10
202-Y	3/8 inch	1	SWITCHARMY	\$0.45	\$3.00
202-Z	1/4 inch	1	SWITCHBURG	.45	3.00



All illustrations 1/2 actual size

SWITCHES

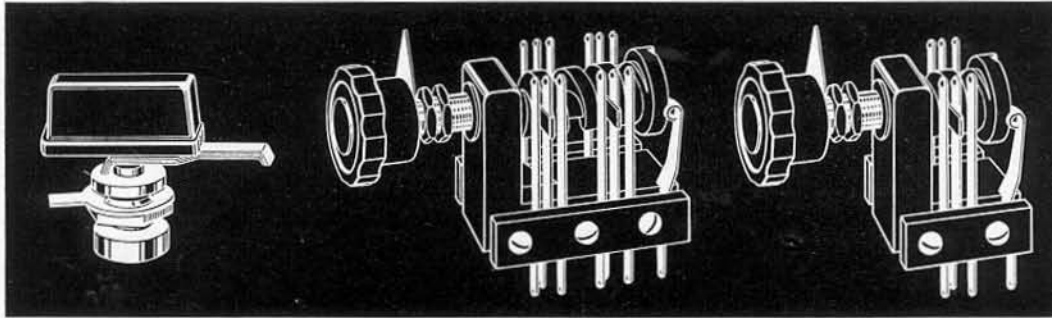

Type 202

This is a quadruple-leaf phosphor-bronze switch which makes wiping contact on both the switch points and the fixed bushing. It is intended for use with TYPE 138-B or TYPE 138-C Switch Contacts mounted on a 1 3/8-inch radius.

Type 339-A

and

Type 339-B

This is a rotary, 3-position switch for all applications where a toggle-switch-action "anti-capacity" switch would ordinarily be used. The entire throw is 180°, from one position through "off" to the third position, each position being marked by a detent device. The movable switch blades are actuated by a moulded bakelite worm.

Only one mounting hole is required for all panels up to 3/8 inch thick. Both 4-pole double-throw and 2-pole double-throw models are available. The contact springs can be bent for switching in unusual circuits.

The capacitance between switch elements is low. The switch itself is insulated for all voltages up to 250 volts, and the contacts will safely break 2 amperes.

Type	Panel Thickness	Code Word	Price	Type	Description	Code Word	Price
202-A	1/8 to 1/4 in.	SWITCHTOAD	\$0.75	339-A	4-Pole, Double Throw	PUPPY	\$2.50
202-B	1/4 to 3/8 in.	SWITCHGOOD	.75	339-B	2-Pole, Double Throw	PUTTY	2.00

SWITCH CONTACTS AND STOPS

Switch contacts are available made of nickel-plated bronze and are either with plane faces or with cupped-shaped depressions which act as detents definitely to center the switch blade in position. Each switch contact has a

knurled shoulder which, when drawn into the panel by tightening the nut, prevents rotation of the contact head.

The switch stop is made of nickel-plated brass, and is without a knurled shoulder.



138-B

138-C

138-D

138-Q

Type	Description	Dimensions			
		A	B	C	D
138-B	Plane Switch Contact	1/4"	3/16"	#10 drill	3/8" max.
138-C	Plane Switch Contact	5/16"	3/16"	#10 drill	1/2" max.
138-D	Plane Switch Contact	3/16"	3/16"	#28 drill	1/2"
138-Q	Switch Stop	5/16"	7/16"	6-32 stud	3/8" max.

Type	Code Word	Price		
		Unit	Package of 10	Package of 100
138-B	CONTACTANT	\$0.10	\$0.40	\$2.25
138-C	CONTACTBUG	.10	.50	3.20
138-D	CONTACTCAT	.10	.40	2.20
138-Q	STANPARBUL	.10	.40	2.25

## BINDING POSTS AND ASSEMBLIES

Particular attention is directed to the three binding posts having jack tops which take plugs of the TYPE 274 series. (TYPE 138-VD, TYPE 138-V with longer stud, is not illustrated.)

The binding-post assemblies are convenient means for mounting binding posts on metal panels. The TYPE 274-K is designed for mounting, by drive fit, in a bakelite panel.

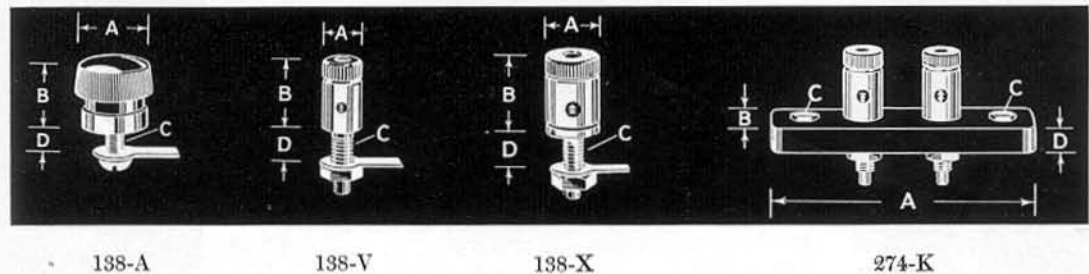

Type	Description	Dimensions			
		A	B	C	D
138-A	Binding Post (bakelite top)	3/4"	3/4" min.	10-32	3/8" max.
138-V	Binding Post (small jack top)	3/8"	1/16" min.	10-32	1/2" max.
138-VD	Binding Post (small jack top, long stud)	3/8"	1/16" min.	10-32	7/8" max.
138-X	Binding Post (large jack top)	1/2"	1/16" min.	10-32	1/2" max.
274-K	Assembly (with 138-V Posts)	29/16"	1"	6-32	1/4"
274-L	Assembly (with 138-X Posts)	29/16"	1"	6-32	1/4"

Type	Code Word	Price		
		Unit	Package of 10	Package of 100
138-A	STANPARCUP	\$0.25	\$1.50	\$13.50
138-V	STANPARANT	.25	1.35	12.00
138-VD	STANPARFUN	.25	1.35	12.00
138-X	STANPARBOY	.25	1.35	12.00
274-K	STANPARBAG	.65	—	—
274-L	STANPARTAG	.65	—	—

PLUGS AND JACKS

The following section lists small parts which the laboratory worker and amateur will find useful in the construction of his equipment.

All multiple plugs and jacks have the General Radio standard  $\frac{3}{4}$ -inch spacing between centers.



**Type 274-P Plug**

Basic plug unit—Max. current, 8 a.

- A =  $\frac{5}{16}$  inch max.
- B =  $\frac{1}{8}$  inch
- C = 6-32
- D =  $\frac{5}{8}$  inch

Code Word: STANPARCAT  
 Unit Price . . . \$0.12  
 Package of 10 . . . .70  
 Package of 100 . . . 5.25

**Type 274-J Jack**

Basic jack unit.

- A =  $\frac{7}{16}$  inch
- B =  $\frac{3}{8}$  inch max.
- C =  $\frac{1}{4}$  inch—28

Code Word: STANPARTOP  
 Unit Price . . . \$0.10  
 Package of 10 . . . .45  
 Package of 100 . . . 2.25

**Type 274-X Plug**

As illustrated with tubular rivet top.

- A = 0.135 inch, diam.
- B =  $\frac{3}{16}$  inch
- C =  $\frac{1}{8}$  inch
- D =  $\frac{1}{2}$  inch

Code Word: STANPARTIN  
 Unit Price . . . \$0.10  
 Package of 10 . . . .60  
 Package of 100 . . . 4.25

**Type 274-U Single Plug**

Like TYPE 274-E but without thumbscrew.

- A =  $\frac{7}{16}$  inch C =  $\frac{1}{4}$  inch—28
- B =  $\frac{3}{8}$  inch max. D =  $\frac{1}{4}$  inch

Code Word: STANPARGOT  
 Unit Price . . . \$0.15  
 Package of 10 . . . 1.00  
 Package of 100 . . . 8.00

**Type 274-D Insulated Plug**

Similar to TYPE 274-E but with bakelite sleeve.

- A =  $\frac{1}{2}$  inch B =  $\frac{15}{16}$  inch

Code Word: STANPAREYE  
 Unit Price . . . \$0.25  
 Package of 10 . . . 2.25

**Type 274-SB Short-Circuit Plug**

TYPE 274-U Plugs with a nickel-plated brass bar.

Code Word: STANPARZIP  
 Price . . . . \$0.65

**Type 274-M, -ML Double Plugs**

Moulded bakelite with jacks in top and setscrews for cord tips.  $\frac{3}{4}$ -inch spacing.

- A =  $1\frac{1}{4}$  inch B =  $1\frac{3}{4}$  inch

**Type 274-M**

Code Word: STANPARBUG  
 Unit Price . . . \$0.40  
 Package of 10 . . . 2.60

**Type 274-ML**

Low-loss (yellow) bakelite.

Code Word: STANPARBUY  
 Unit Price . . . \$0.45  
 Package of 10 . . . 3.00

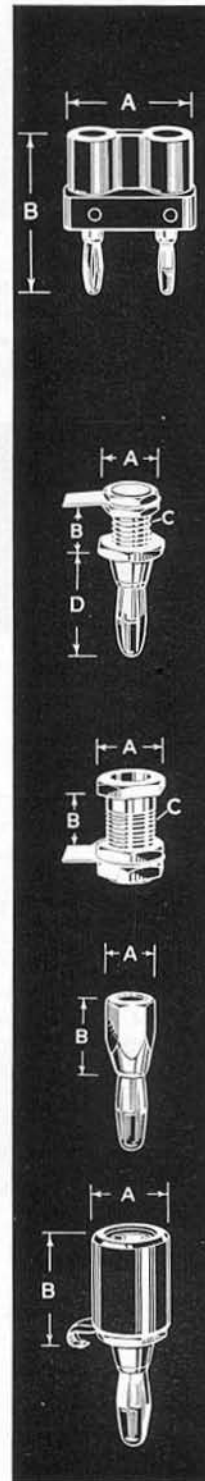

**Type 674-P Jumbo Plug**

Basic jumbo-plug unit—Max. current, 25 a.

- A =  $\frac{3}{4}$  inch
- B =  $\frac{3}{8}$  inch
- C =  $\frac{3}{8}$  inch—32
- D =  $1\frac{3}{16}$  inch

Code Word: STANPARAPE  
 Unit Price . . . \$0.30  
 Package of 10 . . . 1.75

**Type 674-J Jumbo Jack**

Basic jumbo-jack unit.

- A =  $\frac{3}{4}$  inch
- B =  $\frac{3}{16}$  inch max.
- C =  $\frac{1}{2}$  inch—20

Code Word: STANPARAYE  
 Unit Price . . . \$0.30  
 Package of 10 . . . 1.65

**Type 674-D Insulated Jumbo Plug**

With insulated shank and soldering lug—jack in top.

- A =  $\frac{3}{4}$  inch B =  $1\frac{1}{16}$  inch

Code Word: STANPARARK  
 Unit Price . . . \$0.50  
 Package of 10 . . . 4.00

**Type 674-C Jumbo Plug**

With solder-filled cup in shank for sweating-in.  $\frac{1}{4}$ -inch tubing.

- A =  $\frac{1}{2}$  inch B =  $\frac{3}{4}$  inch

Code Word: STANPARCOX  
 Unit Price . . . \$0.25  
 Package of 10 . . . 1.50



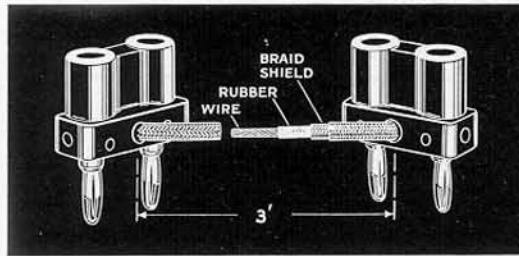

**Type 274-NC Shielded Conductor**

A concentric-shielded conductor with plugs.  
 Capacitance: 100  $\mu\text{mf}$  per foot  
 Impedance: About 30 ohms  
 Code Word: STANPARZOO Price: \$1.50

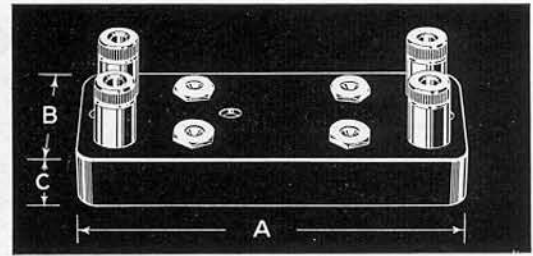

**Type 274-RJ Four-Gang Jack Base**

For mounting thermocouples, oxide rectifiers, etc.  
 A = 3  $\frac{3}{4}$  inches C =  $\frac{9}{16}$  inch  
 B = 1  $\frac{1}{2}$  inches  
 Code Word: STANPARPUP Price: \$1.00

**TYPE 274 PANEL TERMINAL INSULATOR ASSEMBLY**

These are bakelite insulators, used in pairs with TYPE 138-VD Binding Posts, for mounting on a metal panel. They are available in either black or low-loss natural bakelite.

A = 1  $\frac{1}{2}$  inches C =  $\frac{3}{16}$  inch diam.  
 B =  $\frac{3}{4}$  inch D =  $\frac{1}{8}$  inch to  $\frac{5}{16}$  inch

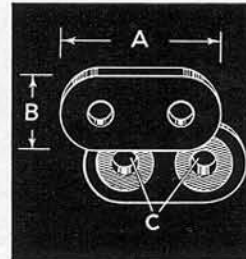

TWO  
 TYPE  
 138-  
 VD

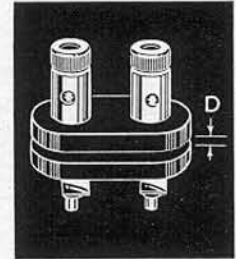

Type	Bakelite Material	Code Word	Price	
			(Pair)	Package of 10 Pairs
274-Y	Black	STANPARBEL	\$0.20	\$1.35
274-Z	Yellow	STANPARHOD	.30	2.10

**TYPE 119-A RADIO-FREQUENCY CHOKE**

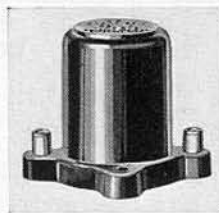

The TYPE 119-A Radio-Frequency Choke is suitable for use at frequencies as high as 40 megacycles. The winding is composed of a large number of thin, spiral-wound pies. This method of construction produces only one resonant point, minor resonances being practically eliminated.

**SPECIFICATIONS**

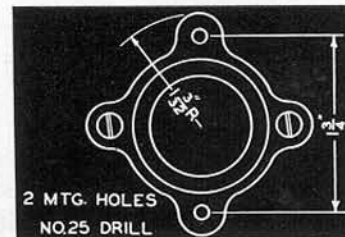

**Inductance:** 250 millihenries.  
**Capacitance:** 2 micromicrofarads.  
**D-C Resistance:** 450 ohms.  
**Maximum Current:** 60 milliamperes.

Type	Code Word	Price
119-A	IMAGE	\$1.50

REACTANCE CHART

Always use corresponding scales

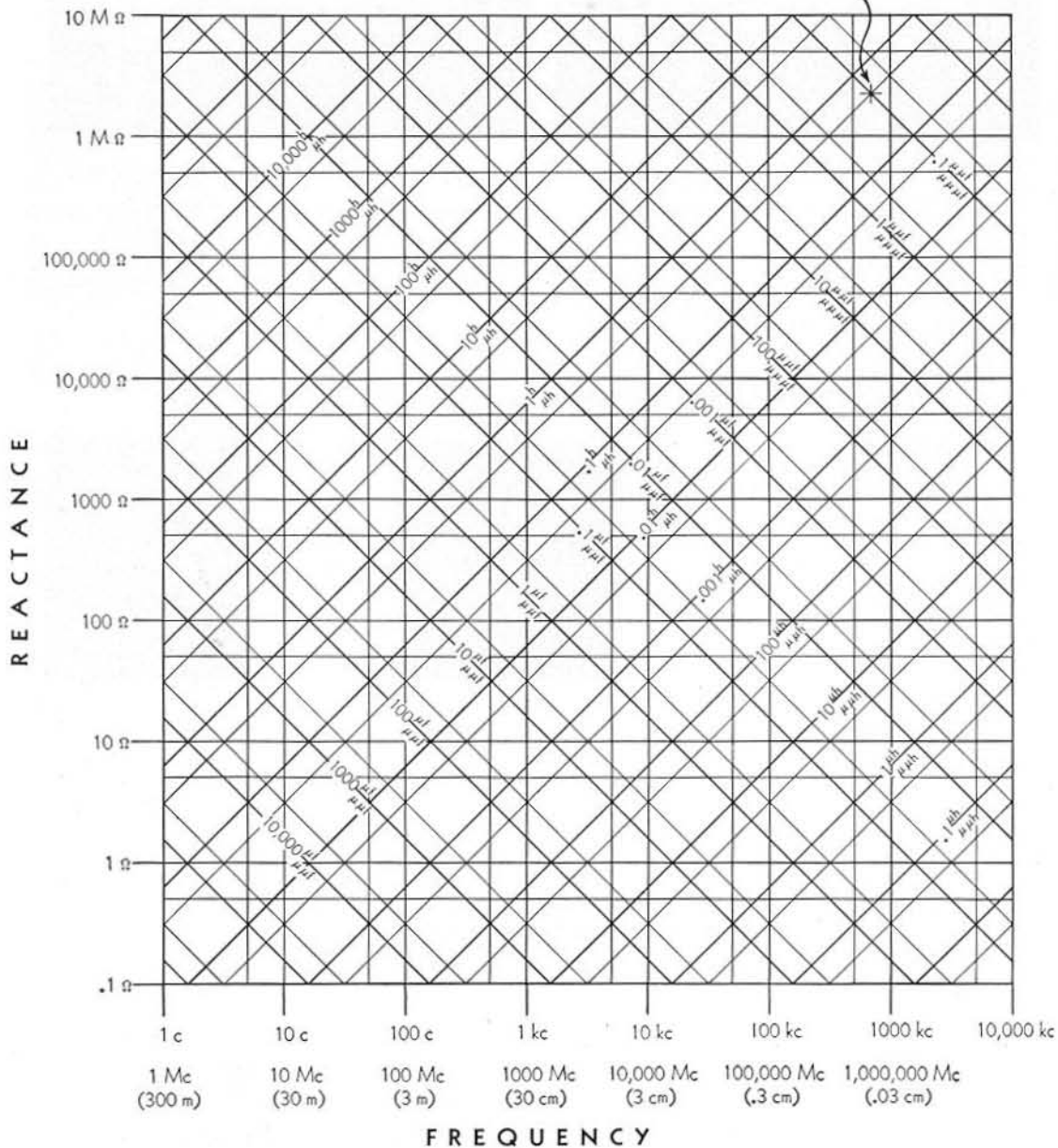

FIG. 1

- The accompanying chart may be used to find:
- (1) The reactance of a given inductance at a given frequency.
  - (2) The reactance of a given capacitance at a given frequency.
  - (3) The resonant frequency of a given inductance and capacitance.

In order to facilitate the determination of magnitude of the quantities involved to two or three significant figures the chart is divided into two parts. Figure 1 is the complete chart to be used for rough

calculations. Figure 2, which is a single decade of Figure 1 enlarged approximately 7 times, is to be used where the significant two or three figures are to be determined.

TO FIND REACTANCE

Enter the charts vertically from the bottom (frequency) and along the lines slanting upward to the left (inductance) or to the right (capacitance). Corresponding scales (upper or lower) must be used throughout. Project horizontally to the left from the intersection and read reactance.

Always obtain approximate value from Figure 1 before using Figure 2

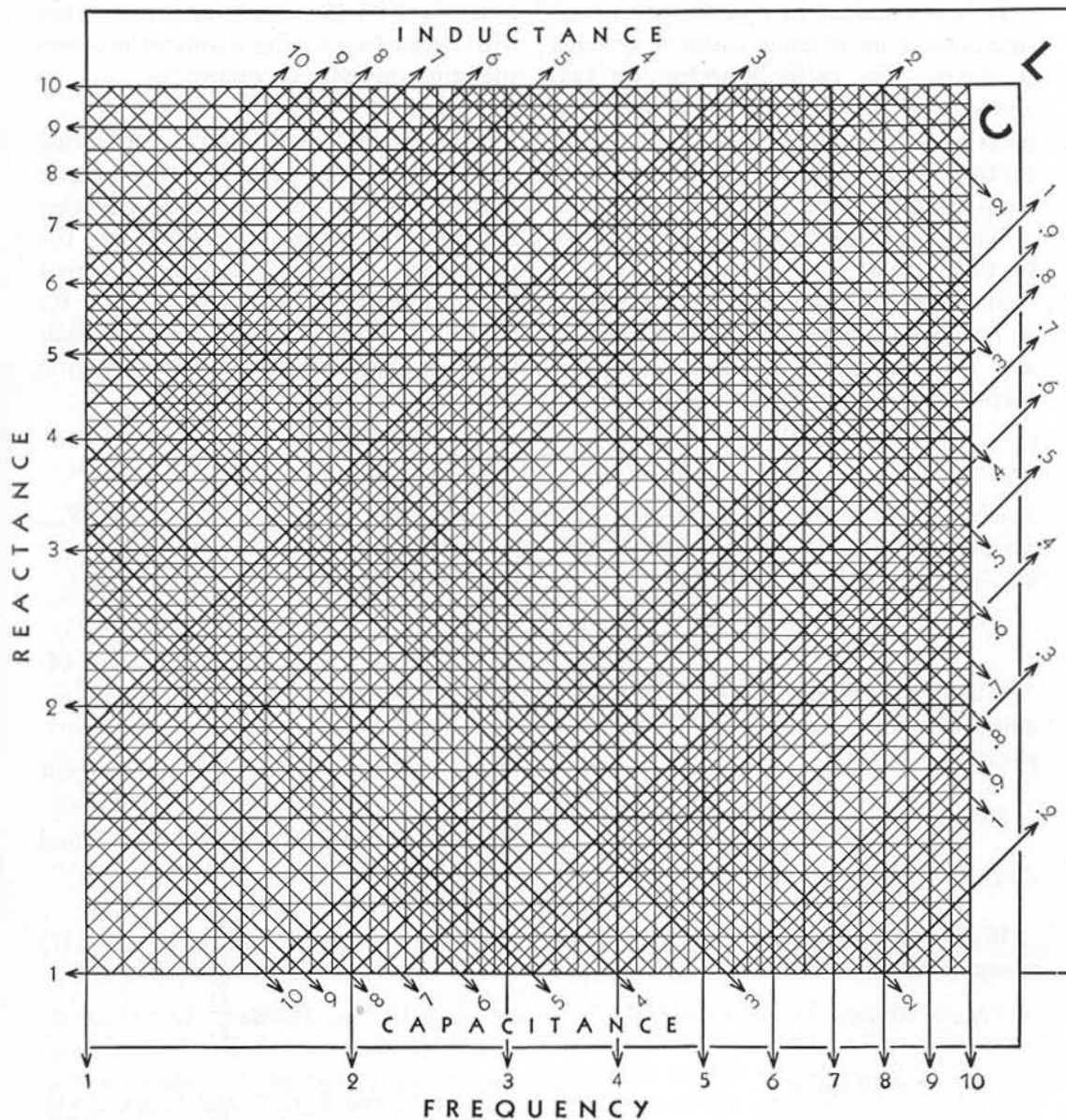

FIG. 2

### TO FIND RESONANT FREQUENCY

Enter the slanting lines for the given inductance and capacitance. Project downward from their intersection and read resonant frequency from the bottom scale. Corresponding scales (upper or lower) must be used throughout.

*Example:* The sample point indicated (Figure 1) corresponds to a frequency of about 700 kc and an inductance of 0.5 henry, or a capacitance of 0.1  $\mu\text{mf}$ , giving in either case a reactance of about 2,000,000 ohms. The resonant frequency of a circuit containing these values of inductance and capacitance is, of course, 700 kc, approximately.

### USE OF FIGURE 2

Figure 2 is used to obtain additional precision of reading but does not place the decimal point which must be located from a preliminary entry on Figure 1. Since the chart necessarily requires two logarithmic decades for inductance and capacitance for every single decade of frequency and reactance, unless the correct decade for L and C is chosen, the calculated values of reactance and frequency will be in error by a factor of 3.16.

*Example:* (Continued.) The reactance corresponding to 0.5 henry or 0.1  $\mu\text{mf}$  is 2,230,000 ohms at 712 kc, their resonant frequency.

## DECIBEL CONVERSION TABLES

It is convenient in measurements and calculations on communications systems to express the ratio between any two amounts of electric or acoustic power in units on a logarithmic scale. The *decibel* (1/10th of the *bel*) on the briggsian or base-10 scale and the *neper* on the napierian or base- $e$  scale are in almost universal use for this purpose.

Since voltage and current are related to power by impedance, both the *decibel* and the *neper* can be used to express voltage and current ratios, if care is taken

to account for the impedances associated with them. In a similar manner the corresponding acoustical quantities can be compared.

Table I and Table II on the following pages have been prepared to facilitate making conversions in either direction between the number of *decibels* and the corresponding power, voltage, and current ratios. Both tables can also be used for *nepers* and the *mile of standard cable* by applying the conversion factors from the table on the opposite page.

*Decibel*—The number of decibels  $N_{db}$  corresponding to the ratio between two amounts of power  $P_1$  and  $P_2$  is

$$N_{db} = 10 \log_{10} \frac{P_1}{P_2} \quad (1)$$

When two voltages  $E_1$  and  $E_2$  or two currents  $I_1$  and  $I_2$  operate in the same or equal impedances,

$$N_{db} = 20 \log_{10} \frac{E_1}{E_2} \quad (2)$$

and 
$$N_{db} = 20 \log_{10} \frac{I_1}{I_2} \quad (3)$$

If  $E_1$  and  $E_2$  or  $I_1$  and  $I_2$  operate in unequal impedances,

$$N_{db} = 20 \log_{10} \frac{E_1}{E_2} + 10 \log_{10} \frac{Z_2}{Z_1} + 10 \log_{10} \frac{k_2}{k_1} \quad (4)$$

and 
$$N_{db} = 20 \log_{10} \frac{I_1}{I_2} + 10 \log_{10} \frac{Z_1}{Z_2} + 10 \log_{10} \frac{k_1}{k_2} \quad (5)$$

where  $Z_1$  and  $Z_2$  are the absolute magnitudes of the corresponding impedances and  $k_1$  and  $k_2$  are the values of power factor for the impedances. Note that Table I and Table II can be used to evaluate the impedance and power factor terms, since both are similar to the expression for power ratio, equation (1).

*Neper*—The number of nepers  $N_{nep}$  corresponding to a power ratio  $\frac{P_1}{P_2}$  is

$$N_{nep} = \frac{1}{2} \log_e \frac{P_1}{P_2} \quad (6)$$

For voltage ratios  $\frac{E_1}{E_2}$  or current ratios  $\frac{I_1}{I_2}$  working in the same or equal impedances,

$$N_{nep} = \log_e \frac{E_1}{E_2} \quad (7)$$

and 
$$N_{nep} = \log_e \frac{I_1}{I_2}$$

When  $E_1$  and  $E_2$  or  $I_1$  and  $I_2$  operate in unequal impedances,

$$N_{nep} = \log_e \frac{E_1}{E_2} + \frac{1}{2} \log_e \frac{Z_2}{Z_1} + \frac{1}{2} \log_e \frac{k_2}{k_1} \quad (8)$$

and

$$N_{nep} = \log_e \frac{I_1}{I_2} + \frac{1}{2} \log_e \frac{Z_1}{Z_2} + \frac{1}{2} \log_e \frac{k_1}{k_2} \quad (9)$$

where  $Z_1$  and  $Z_2$  and  $k_1$  and  $k_2$  are as in equations (4) and (5).



# DECIBEL CONVERSION TABLES

## RELATIONS BETWEEN DECIBELS, NEPERS, AND MILES OF STANDARD CABLE

<i>Multiply</i>	<i>By</i>	<i>To Find</i>
decibels . . . . .	.1151	nepers
decibels . . . . .	1.056	miles of standard cable
miles of standard cable	.947	decibels
miles of standard cable	.109	nepers
nepers . . . . .	8.686	decibels
nepers . . . . .	9.175	miles of standard cable

### TO FIND VALUES OUTSIDE THE RANGE OF CONVERSION TABLES

Values outside the range of either Table I or Table II on the following pages can

be readily found with the help of the following simple rules.

**TABLE I: DECIBELS TO VOLTAGE AND POWER RATIOS**

**Number of decibels positive (+):** Subtract +20 decibels successively from the given number of decibels until the remainder falls within range of Table I. *To find the voltage ratio*, multiply the corresponding value from the right-hand voltage-ratio column by 10 for each time you subtracted 20 db. *To find the power ratio*, multiply the corresponding value from the right-hand power-ratio column by 100 for each time you subtracted 20 db.

**Example—Given:** 49.2 db  
 $49.2 \text{ db} - 20 \text{ db} - 20 \text{ db} = 9.2 \text{ db}$   
*Voltage ratio:* 9.2 db →  
 $2.884 \times 10 \times 10 = 288.4$   
*Power ratio:* 9.2 db →  
 $8.318 \times 100 \times 100 = 83180$

**Number of decibels negative (−):** Add +20 decibels successively to the given number of decibels until the sum falls within the range of Table I. *For the voltage ratio*, divide the value from the left-hand voltage-ratio column by 10 for each time you added 20 db. *For the power ratio*, divide the value from the left-hand power-ratio column by 100 for each time you added 20 db.

**Example—Given:** −49.2 db  
 $-49.2 \text{ db} + 20 \text{ db} + 20 \text{ db} = -9.2 \text{ db}$   
*Voltage ratio:* −9.2 db →  
 $.3467 \times 1/10 \times 1/10 = .003467$   
*Power ratio:* −9.2 db →  
 $.1202 \times 1/100 \times 1/100 = .00001202$

**TABLE II: VOLTAGE RATIOS TO DECIBELS**

**For ratios smaller than those in table—**Multiply the given ratio by 10 successively until the product can be found in the table. From the number of decibels thus found, subtract +20 decibels for each time you multiplied by 10.

**Example—Given:** Voltage ratio = .0131  
 $.0131 \times 10 = .131 \times 10 = 1.31$

From Table II, 1.31 →  
 $2.345 \text{ db} - 20 \text{ db} - 20 \text{ db} = -37.655 \text{ db}$

**For ratios greater than those in table—**Divide the given ratio by 10 successively until the remainder can be found in the table. To the number of decibels thus found, add +20 db for each time you divided by 10.

**Example—Given:** Voltage ratio = 712  
 $712 \times 1/10 = 71.2 \times 1/10 = 7.12$

From Table II, 7.12 →  
 $17.050 \text{ db} + 20 \text{ db} + 20 \text{ db} = 57.050 \text{ db}$

TABLE I

GIVEN: Decibels

TO FIND: Power and  $\left\{ \begin{matrix} \text{Voltage} \\ \text{Current} \end{matrix} \right\}$  Ratios

TO ACCOUNT FOR THE SIGN OF THE DECIBEL

For positive (+) values of the decibel— Both voltage and power ratios are greater than unity. Use the two right-hand columns.

For negative (−) values of the decibel— Both voltage and power ratios are less than unity. Use the two left-hand columns.

Example—Given: ±9.1 db. Find:

	Power Ratio	Voltage Ratio
+9.1 db	8.128	2.851
−9.1 db	0.1230	0.3508

← -db+ →					← -db+ →				
Voltage Ratio	Power Ratio	db	Voltage Ratio	Power Ratio	Voltage Ratio	Power Ratio	db	Voltage Ratio	Power Ratio
<b>1.0000</b>	<b>1.0000</b>	<b>0</b>	<b>1.000</b>	<b>1.000</b>	<b>.5623</b>	<b>.3162</b>	<b>5.0</b>	<b>1.778</b>	<b>3.162</b>
.9886	.9772	.1	1.012	1.023	.5559	.3090	5.1	1.799	3.236
.9772	.9550	.2	1.023	1.047	.5495	.3020	5.2	1.820	3.311
.9661	.9333	.3	1.035	1.072	.5433	.2951	5.3	1.841	3.388
.9550	.9120	.4	1.047	1.096	.5370	.2884	5.4	1.862	3.467
.9441	.8913	.5	1.059	1.122	.5309	.2818	5.5	1.884	3.548
.9333	.8710	.6	1.072	1.148	.5248	.2754	5.6	1.905	3.631
.9226	.8511	.7	1.084	1.175	.5188	.2692	5.7	1.928	3.715
.9120	.8318	.8	1.096	1.202	.5129	.2630	5.8	1.950	3.802
.9016	.8128	.9	1.109	1.230	.5070	.2570	5.9	1.972	3.890
<b>.8913</b>	<b>.7943</b>	<b>1.0</b>	<b>1.122</b>	<b>1.259</b>	<b>.5012</b>	<b>.2512</b>	<b>6.0</b>	<b>1.995</b>	<b>3.981</b>
.8810	.7762	1.1	1.135	1.288	.4955	.2455	6.1	2.018	4.074
.8710	.7586	1.2	1.148	1.318	.4898	.2399	6.2	2.042	4.169
.8610	.7413	1.3	1.161	1.349	.4842	.2344	6.3	2.065	4.266
.8511	.7244	1.4	1.175	1.380	.4786	.2291	6.4	2.089	4.365
.8414	.7079	1.5	1.189	1.413	.4732	.2239	6.5	2.113	4.467
.8318	.6918	1.6	1.202	1.445	.4677	.2188	6.6	2.138	4.571
.8222	.6761	1.7	1.216	1.479	.4624	.2138	6.7	2.163	4.677
.8128	.6607	1.8	1.230	1.514	.4571	.2089	6.8	2.188	4.786
.8035	.6457	1.9	1.245	1.549	.4519	.2042	6.9	2.213	4.898
<b>.7943</b>	<b>.6310</b>	<b>2.0</b>	<b>1.259</b>	<b>1.585</b>	<b>.4467</b>	<b>.1995</b>	<b>7.0</b>	<b>2.239</b>	<b>5.012</b>
.7852	.6166	2.1	1.274	1.622	.4416	.1950	7.1	2.265	5.129
.7762	.6026	2.2	1.288	1.660	.4365	.1905	7.2	2.291	5.248
.7674	.5888	2.3	1.303	1.698	.4315	.1862	7.3	2.317	5.370
.7586	.5754	2.4	1.318	1.738	.4266	.1820	7.4	2.344	5.495
.7499	.5623	2.5	1.334	1.778	.4217	.1778	7.5	2.371	5.623
.7413	.5495	2.6	1.349	1.820	.4169	.1738	7.6	2.399	5.754
.7328	.5370	2.7	1.365	1.862	.4121	.1698	7.7	2.427	5.888
.7244	.5248	2.8	1.380	1.905	.4074	.1660	7.8	2.455	6.026
.7161	.5129	2.9	1.396	1.950	.4027	.1622	7.9	2.483	6.166
<b>.7079</b>	<b>.5012</b>	<b>3.0</b>	<b>1.413</b>	<b>1.995</b>	<b>.3981</b>	<b>.1585</b>	<b>8.0</b>	<b>2.512</b>	<b>6.310</b>
.6998	.4898	3.1	1.429	2.042	.3936	.1549	8.1	2.541	6.457
.6918	.4786	3.2	1.445	2.089	.3890	.1514	8.2	2.570	6.607
.6839	.4677	3.3	1.462	2.138	.3846	.1479	8.3	2.600	6.761
.6761	.4571	3.4	1.479	2.188	.3802	.1445	8.4	2.630	6.918
.6683	.4467	3.5	1.496	2.239	.3758	.1413	8.5	2.661	7.079
.6607	.4365	3.6	1.514	2.291	.3715	.1380	8.6	2.692	7.244
.6531	.4266	3.7	1.531	2.344	.3673	.1349	8.7	2.723	7.413
.6457	.4169	3.8	1.549	2.399	.3631	.1318	8.8	2.754	7.586
.6383	.4074	3.9	1.567	2.455	.3589	.1288	8.9	2.786	7.762
<b>.6310</b>	<b>.3981</b>	<b>4.0</b>	<b>1.585</b>	<b>2.512</b>	<b>.3548</b>	<b>.1259</b>	<b>9.0</b>	<b>2.818</b>	<b>7.943</b>
.6237	.3890	4.1	1.603	2.570	.3508	.1230	9.1	2.851	8.128
.6166	.3802	4.2	1.622	2.630	.3467	.1202	9.2	2.884	8.318
.6095	.3715	4.3	1.641	2.692	.3428	.1175	9.3	2.917	8.511
.6026	.3631	4.4	1.660	2.754	.3388	.1148	9.4	2.951	8.710
.5957	.3548	4.5	1.679	2.818	.3350	.1122	9.5	2.985	8.913
.5888	.3467	4.6	1.698	2.884	.3311	.1096	9.6	3.020	9.120
.5821	.3388	4.7	1.718	2.951	.3273	.1072	9.7	3.055	9.333
.5754	.3311	4.8	1.738	3.020	.3236	.1047	9.8	3.090	9.550
.5689	.3236	4.9	1.758	3.090	.3199	.1023	9.9	3.126	9.772



TABLE II

GIVEN:  $\left\{ \begin{matrix} \text{Voltage} \\ \text{Current} \end{matrix} \right\}$  Ratio TO FIND: Decibels

POWER RATIOS

To find the number of decibels corresponding to a given power ratio—Assume the given power ratio to be a voltage ratio and find the corresponding number of decibels from the table. The desired result is exactly

one-half of the number of decibels thus found.

Example—Given: a power ratio of 3.41.  
Find: 3.41 in the table:

$$3.41 \rightarrow 10.655 \text{ db} \times \frac{1}{2} = 5.328 \text{ db}$$

Voltage Ratio	.00	.01	.02	.03	.04	.05	.06	.07	.08	.09
1.0	.000	.086	.172	.257	.341	.424	.506	.588	.668	.749
1.1	.828	.906	.984	1.062	1.138	1.214	1.289	1.364	1.438	1.511
1.2	1.584	1.656	1.727	1.798	1.868	1.938	2.007	2.076	2.144	2.212
1.3	2.279	2.345	2.411	2.477	2.542	2.607	2.671	2.734	2.798	2.860
1.4	2.923	2.984	3.046	3.107	3.167	3.227	3.287	3.346	3.405	3.464
1.5	3.522	3.580	3.637	3.694	3.750	3.807	3.862	3.918	3.973	4.028
1.6	4.082	4.137	4.190	4.244	4.297	4.350	4.402	4.454	4.506	4.558
1.7	4.609	4.660	4.711	4.761	4.811	4.861	4.910	4.959	5.008	5.057
1.8	5.105	5.154	5.201	5.249	5.296	5.343	5.390	5.437	5.483	5.529
1.9	5.575	5.621	5.666	5.711	5.756	5.801	5.845	5.889	5.933	5.977
2.0	6.021	6.064	6.107	6.150	6.193	6.235	6.277	6.319	6.361	6.403
2.1	6.444	6.486	6.527	6.568	6.608	6.649	6.689	6.729	6.769	6.809
2.2	6.848	6.888	6.927	6.966	7.008	7.044	7.082	7.121	7.159	7.197
2.3	7.235	7.272	7.310	7.347	7.384	7.421	7.458	7.495	7.532	7.568
2.4	7.604	7.640	7.676	7.712	7.748	7.783	7.819	7.854	7.889	7.924
2.5	7.959	7.993	8.028	8.062	8.097	8.131	8.165	8.199	8.232	8.266
2.6	8.299	8.333	8.366	8.399	8.432	8.465	8.498	8.530	8.563	8.595
2.7	8.627	8.659	8.691	8.723	8.755	8.787	8.818	8.850	8.881	8.912
2.8	8.943	8.974	9.005	9.036	9.066	9.097	9.127	9.158	9.188	9.218
2.9	9.248	9.278	9.308	9.337	9.367	9.396	9.426	9.455	9.484	9.513
3.0	9.542	9.571	9.600	9.629	9.657	9.686	9.714	9.743	9.771	9.799
3.1	9.827	9.855	9.883	9.911	9.939	9.966	9.994	10.021	10.049	10.076
3.2	10.103	10.130	10.157	10.184	10.211	10.238	10.264	10.291	10.317	10.344
3.3	10.370	10.397	10.423	10.449	10.475	10.501	10.527	10.553	10.578	10.604
3.4	10.630	10.655	10.681	10.706	10.731	10.756	10.782	10.807	10.832	10.857
3.5	10.881	10.906	10.931	10.955	10.980	11.005	11.029	11.053	11.078	11.102
3.6	11.126	11.150	11.174	11.198	11.222	11.246	11.270	11.293	11.317	11.341
3.7	11.364	11.387	11.411	11.434	11.457	11.481	11.504	11.527	11.550	11.573
3.8	11.596	11.618	11.641	11.664	11.687	11.709	11.732	11.754	11.777	11.799
3.9	11.821	11.844	11.866	11.888	11.910	11.932	11.954	11.976	11.998	12.019
4.0	12.041	12.063	12.085	12.106	12.128	12.149	12.171	12.192	12.213	12.234
4.1	12.256	12.277	12.298	12.319	12.340	12.361	12.382	12.403	12.424	12.444
4.2	12.465	12.486	12.506	12.527	12.547	12.568	12.588	12.609	12.629	12.649
4.3	12.669	12.690	12.710	12.730	12.750	12.770	12.790	12.810	12.829	12.849
4.4	12.869	12.889	12.908	12.928	12.948	12.967	12.987	13.006	13.026	13.045
4.5	13.064	13.084	13.103	13.122	13.141	13.160	13.179	13.198	13.217	13.236
4.6	13.255	13.274	13.293	13.312	13.330	13.349	13.368	13.386	13.405	13.423
4.7	13.442	13.460	13.479	13.497	13.516	13.534	13.552	13.570	13.589	13.607
4.8	13.625	13.643	13.661	13.679	13.697	13.715	13.733	13.751	13.768	13.786
4.9	13.804	13.822	13.839	13.857	13.875	13.892	13.910	13.927	13.945	13.962
5.0	13.979	13.997	14.014	14.031	14.049	14.066	14.083	14.100	14.117	14.134
5.1	14.151	14.168	14.185	14.202	14.219	14.236	14.253	14.270	14.287	14.303
5.2	14.320	14.337	14.353	14.370	14.387	14.403	14.420	14.436	14.453	14.469
5.3	14.486	14.502	14.518	14.535	14.551	14.567	14.583	14.599	14.616	14.632
5.4	14.648	14.664	14.680	14.696	14.712	14.728	14.744	14.760	14.776	14.791
5.5	14.807	14.823	14.839	14.855	14.870	14.886	14.902	14.917	14.933	14.948
5.6	14.964	14.979	14.995	15.010	15.026	15.041	15.056	15.072	15.087	15.102
5.7	15.117	15.133	15.148	15.163	15.178	15.193	15.208	15.224	15.239	15.254
5.8	15.269	15.284	15.298	15.313	15.328	15.343	15.358	15.373	15.388	15.402
5.9	15.417	15.432	15.446	15.461	15.476	15.490	15.505	15.519	15.534	15.549



TABLE II (continued)

<i>Voltage Ratio</i>	.00	.01	.02	.03	.04	.05	.06	.07	.08	.09
6.0	15.563	15.577	15.592	15.606	15.621	15.635	15.649	15.664	15.678	15.692
6.1	15.707	15.721	15.735	15.749	15.763	15.778	15.792	15.806	15.820	15.834
6.2	15.848	15.862	15.876	15.890	15.904	15.918	15.931	15.945	15.959	15.973
6.3	15.987	16.001	16.014	16.028	16.042	16.055	16.069	16.083	16.096	16.110
6.4	16.124	16.137	16.151	16.164	16.178	16.191	16.205	16.218	16.232	16.245
6.5	16.258	16.272	16.285	16.298	16.312	16.325	16.338	16.351	16.365	16.378
6.6	16.391	16.404	16.417	16.430	16.443	16.456	16.469	16.483	16.496	16.509
6.7	16.521	16.534	16.547	16.560	16.573	16.586	16.599	16.612	16.625	16.637
6.8	16.650	16.663	16.676	16.688	16.701	16.714	16.726	16.739	16.752	16.764
6.9	16.777	16.790	16.802	16.815	16.827	16.840	16.852	16.865	16.877	16.890
7.0	16.902	16.914	16.927	16.939	16.951	16.964	16.976	16.988	17.001	17.013
7.1	17.025	17.037	17.050	17.062	17.074	17.086	17.098	17.110	17.122	17.135
7.2	17.147	17.159	17.171	17.183	17.195	17.207	17.219	17.231	17.243	17.255
7.3	17.266	17.278	17.290	17.302	17.314	17.326	17.338	17.349	17.361	17.373
7.4	17.385	17.396	17.408	17.420	17.431	17.443	17.455	17.466	17.478	17.490
7.5	17.501	17.513	17.524	17.536	17.547	17.559	17.570	17.582	17.593	17.605
7.6	17.616	17.628	17.639	17.650	17.662	17.673	17.685	17.696	17.707	17.719
7.7	17.730	17.741	17.752	17.764	17.775	17.786	17.797	17.808	17.820	17.831
7.8	17.842	17.853	17.864	17.875	17.886	17.897	17.908	17.919	17.931	17.942
7.9	17.953	17.964	17.975	17.985	17.996	18.007	18.018	18.029	18.040	18.051
8.0	18.062	18.073	18.083	18.094	18.105	18.116	18.127	18.137	18.148	18.159
8.1	18.170	18.180	18.191	18.202	18.212	18.223	18.234	18.244	18.255	18.266
8.2	18.276	18.287	18.297	18.308	18.319	18.329	18.340	18.350	18.361	18.371
8.3	18.382	18.392	18.402	18.413	18.423	18.434	18.444	18.455	18.465	18.475
8.4	18.486	18.496	18.506	18.517	18.527	18.537	18.547	18.558	18.568	18.578
8.5	18.588	18.599	18.609	18.619	18.629	18.639	18.649	18.660	18.670	18.680
8.6	18.690	18.700	18.710	18.720	18.730	18.740	18.750	18.760	18.770	18.780
8.7	18.790	18.800	18.810	18.820	18.830	18.840	18.850	18.860	18.870	18.880
8.8	18.890	18.900	18.909	18.919	18.929	18.939	18.949	18.958	18.968	18.978
8.9	18.988	18.998	19.007	19.017	19.027	19.036	19.046	19.056	19.066	19.075
9.0	19.085	19.094	19.104	19.114	19.123	19.133	19.143	19.152	19.162	19.171
9.1	19.181	19.190	19.200	19.209	19.219	19.228	19.238	19.247	19.257	19.266
9.2	19.276	19.285	19.295	19.304	19.313	19.323	19.332	19.342	19.351	19.360
9.3	19.370	19.379	19.388	19.398	19.407	19.416	19.426	19.435	19.444	19.453
9.4	19.463	19.472	19.481	19.490	19.499	19.509	19.518	19.527	19.536	19.545
9.5	19.554	19.564	19.573	19.582	19.591	19.600	19.609	19.618	19.627	19.636
9.6	19.645	19.654	19.664	19.673	19.682	19.691	19.700	19.709	19.718	19.726
9.7	19.735	19.744	19.753	19.762	19.771	19.780	19.789	19.798	19.807	19.816
9.8	19.825	19.833	19.842	19.851	19.860	19.869	19.878	19.886	19.895	19.904
9.9	19.913	19.921	19.930	19.939	19.948	19.956	19.965	19.974	19.983	19.991

<i>Voltage Ratio</i>	0	1	2	3	4	5	6	7	8	9
10	20.000	20.828	21.584	22.279	22.923	23.522	24.082	24.609	25.105	25.575
20	26.021	26.444	26.848	27.235	27.604	27.959	28.299	28.627	28.943	29.248
30	29.542	29.827	30.103	30.370	30.630	30.881	31.126	31.364	31.596	31.821
40	32.041	32.256	32.465	32.669	32.869	33.064	33.255	33.442	33.625	33.804
50	33.979	34.151	34.320	34.486	34.648	34.807	34.964	35.117	35.269	35.417
60	35.563	35.707	35.848	35.987	36.124	36.258	36.391	36.521	36.650	36.777
70	36.902	37.025	37.147	37.266	37.385	37.501	37.616	37.730	37.842	37.953
80	38.062	38.170	38.276	38.382	38.486	38.588	38.690	38.790	38.890	38.988
90	39.085	39.181	39.276	39.370	39.463	39.554	39.645	39.735	39.825	39.913
100	40.000	—	—	—	—	—	—	—	—	—

To find ratios outside the range of this table, see page 163

# INDEX BY TYPE NUMBER

## INDEX BY TYPE NUMBER

<i>Type</i>	<i>Item</i>	<i>Page</i>	<i>Type</i>	<i>Item</i>	<i>Page</i>
70	Variac Transformer . . . . .	10	434-B	Audio Frequency Meter . . . . .	54
80	Variac Transformer . . . . .	10	471-A	Rheostat-Potentiometer . . . . .	129
100	Variac . . . . .	8	475-A	Frequency Monitor . . . . .	47
106	Standard Inductance . . . . .	41	476-A	Quartz Bar . . . . .	51
107	Variable Inductor . . . . .	42	480	Relay Rack . . . . .	146
119-A	Radio-Frequency Choke . . . . .	159	483	Output Meter . . . . .	122
138	Binding Posts . . . . .	157	484-A	Modulated Oscillator . . . . .	69
138	Switch Contacts and Stops . . . . .	156	484-P	Inductors . . . . .	70
154	Voltage Divider . . . . .	131	487-A	Megohm Meter . . . . .	119
177	Inductor Assembly . . . . .	150	492-A	Oxide Rectifier . . . . .	134
200	Variac . . . . .	8	493	Vacuum Thermocouple . . . . .	136
202	Switch . . . . .	156	500	Resistor . . . . .	22
202	Switch Knob . . . . .	155	505	Condenser . . . . .	37
214-A	Rheostat-Potentiometer . . . . .	128	508-A	Oscillator . . . . .	67
219	Decade Condenser . . . . .	39	509	Standard Condenser . . . . .	36
246	Variable Air Condenser . . . . .	32	510	Decade-Resistance Unit . . . . .	14
247	Variable Air Condenser . . . . .	35	516-C	Radio-Frequency Bridge . . . . .	80
249	Attenuation Box . . . . .	20	519-A	Dial Lens . . . . .	151
274	Plugs and Jacks . . . . .	158	520-A	Dial Lock . . . . .	151
274-RJ	Mounting Base . . . . .	159	522-A	Dial Plate . . . . .	154
274	Panel Terminal Insulators . . . . .	159	525	Resistor . . . . .	23
274-NC	Shielded Conductor . . . . .	159	526	Mounted Rheostat-Potentiometer . . . . .	27
293-A	Universal Bridge . . . . .	86	529-B	Attenuation Box . . . . .	20
293-P	Accessories . . . . .	87	530	Band-Pass Filter . . . . .	113
301-A	Rheostat-Potentiometer . . . . .	131	533-A	Rheostat-Potentiometer . . . . .	130
314-A	Rheostat-Potentiometer . . . . .	129	539	Variable Air Condenser . . . . .	33
318-A	Dial Plate . . . . .	154	539-P	Incremental-Pitch Condenser . . . . .	65
329-J	Attenuation Box . . . . .	20	541	Audio-Frequency Transformer . . . . .	138-145
333-A	Rheostat-Potentiometer . . . . .	130	544-A	Megohm Meter . . . . .	84
334	Variable Air Condenser . . . . .	133	544-P1	Power-Supply Unit . . . . .	85
335-Z	Variable Air Condenser . . . . .	133	546-A	Microvolter . . . . .	117
339	Switch . . . . .	156	548-B	Edgerton Stroboscope . . . . .	1
358	Wavemeter . . . . .	60	549-B	Synchronous-Motor Contactor . . . . .	4
368	Variable Air Condenser . . . . .	134	549-P2	Hand Contactor . . . . .	4
371	Rheostat-Potentiometer . . . . .	128	552	Volume Control . . . . .	25
376-L	Quartz Plate . . . . .	50	561-C	Vacuum-Tube Bridge . . . . .	88
377-B	Low-Frequency Oscillator . . . . .	66	568	Variable Air Condenser . . . . .	132
380	Decade-Condenser Unit . . . . .	40	572-B	Microphone Hummer . . . . .	137
410-A	Rheostat-Potentiometer . . . . .	131	574	Wavemeter . . . . .	58
418	Dummy Antenna . . . . .	99	578	Shielded Transformer . . . . .	91
419-A	Rectifier-Type Wavemeter . . . . .	59			

INDEX BY TYPE NUMBER (continued)

<i>Type</i>	<i>Item</i>	<i>Page</i>	<i>Type</i>	<i>Item</i>	<i>Page</i>
583-A	Output Power Meter . . . . .	121	674	Plugs and Jacks . . . . .	158
585	Audio-Frequency Transformer . . . . .	138-145	675-H	Piezo-Electric Oscillator . . . . .	48
586	Power-Level Indicator . . . . .	120	675-L	Piezo-Electric Oscillator . . . . .	46
588-AM	Direct-Current Meter . . . . .	135	676-A	Quartz Bar and Mounting . . . . .	51
602	Decade-Resistance Box . . . . .	12	677	Inductor Form . . . . .	151
604-B	Test-Signal Generator . . . . .	98	678	Plug and Jack Base . . . . .	151
605-A	Standard-Signal Generator . . . . .	96	681-A	Frequency Deviation Meter . . . . .	47
610-A	Ratio-Arm Box . . . . .	92	682-A	Frequency Deviation Meter . . . . .	47
611	Syncro-Clock . . . . .	56	687-B	Electron Oscillograph and Bedell Sweep Circuit . . . . .	102
612-B	Coupling Panel . . . . .	45	687-P1	Cathode-Ray Tube . . . . .	103
613-B	Beat-Frequency Oscillator . . . . .	64	687-P2	Cathode-Ray Tube . . . . .	103
614-A	Selective Amplifier . . . . .	45	692-A	Multivibrator . . . . .	46
615-A	Heterodyne Frequency Meter . . . . .	48	702	Friction-Drive Dial . . . . .	153
616-B	Heterodyne Frequency Meter . . . . .	45	703	Friction-Drive Dial . . . . .	153
617-B	Interpolation Oscillator . . . . .	45	704	Precision Dial . . . . .	152
619-C	Heterodyne Detector . . . . .	45	705	Friction-Drive Dial . . . . .	154
620-A	Heterodyne Frequency Meter and Calibrator . . . . .	49	706	Precision Dial . . . . .	152
621	Edgerton Power Stroboscope . . . . .	2	710	Direct-Drive Dial . . . . .	153
625-A	Bridge . . . . .	90	712	Direct-Drive Dial . . . . .	154
631-A	Strobotac . . . . .	3	713-A	Beat-Frequency Oscillator . . . . .	62
636-A	Wave Analyzer . . . . .	107	714-A	Amplifier . . . . .	73
637	Fluted Knobs . . . . .	155	716-A	Capacitance Bridge . . . . .	78
642-D	Volume Control . . . . .	26	717	Direct-Drive Dial . . . . .	153
646-A	Logarithmic Resistor . . . . .	19	722	Precision Condenser . . . . .	30
650-A	Impedance Bridge . . . . .	76	724 A	Precision Wavemeter . . . . .	57
651-A-E	Camera Assembly . . . . .	105	725-A	Color Comparator . . . . .	5
651-A-M	Camera Assembly . . . . .	106	726-A	Vacuum-Tube Voltmeter . . . . .	116
653	Volume Control . . . . .	24	730-A	Transmission Monitoring As- sembly . . . . .	109
654-A	Decade Voltage Divider . . . . .	21	731-A	Modulation Monitor . . . . .	110
660-A	Universal Rack . . . . .	147	732-A	Distortion and Noise Meter . . . . .	111
661	Unit Panels and Accessories . . . . .	147	733-A	Oscillator . . . . .	112
666-A	Variable Transformer . . . . .	144	741	Transformer . . . . .	142
667-A	Inductance Bridge . . . . .	83	747-A	Temperature-Control Box . . . . .	52
668	Compensated Decade-Resistance Unit . . . . .	17	759-A	Sound Level Meter . . . . .	6
669	Compensated Slide-Wire Resistor . . . . .	18	813-A	Audio Oscillator . . . . .	68
670	Compensated Decade Resistor . . . . .	16	814-A	Amplifier . . . . .	71
672-A	Power Supply . . . . .	123	815-A	Precision Fork . . . . .	53
673-A	Power Supply . . . . .	124	830	Filter . . . . .	114
			834-A	Electronic Frequency Meter . . . . .	55

INDEX BY TITLE

	<i>Page</i>		<i>Page</i>
Adjustable transformer (Variac) . . . . .	8-10	Dial, direct-drive . . . . .	153
Alternating-current meter . . . . .	122	friction-drive . . . . .	152-154
Amplifier . . . . .	71	lens . . . . .	151
oscillograph . . . . .	73	lock . . . . .	151
selective . . . . .	45	plates . . . . .	154
Analyzer, wave . . . . .	107	precision . . . . .	152
Antenna, dummy . . . . .	99	Direct-current meter . . . . .	135
Attenuation box . . . . .	20	Distortion and noise meter . . . . .	111
Audio-frequency meter . . . . .	54, 55	Dummy antenna . . . . .	99
transformer . . . . .	138-145	Edgerton stroboscope . . . . .	1-3
Audio oscillator . . . . .	64-68, 137	Electron oscillograph . . . . .	102
Band-pass filter . . . . .	113, 114	Electronic frequency meter . . . . .	55
Bars, quartz . . . . .	51	Filter, band-pass . . . . .	113, 114
Base, jack . . . . .	159	high-pass . . . . .	114
Beat-frequency condenser oscillator . . . . .	62, 64	low-pass . . . . .	114
Binding posts and assemblies . . . . .	157	wave . . . . .	113, 114
Bridge accessories . . . . .	93	Fork, precision . . . . .	53
capacitance . . . . .	76, 78	Frequency-deviation meter . . . . .	47
decade . . . . .	86	Frequency meter, audio . . . . .	54, 55
frequency . . . . .	54	meter, electronic . . . . .	55
high-resistance . . . . .	84	meter, heterodyne . . . . .	45, 48
impedance . . . . .	76	monitor . . . . .	47
inductance . . . . .	76, 83	standard . . . . .	44, 46
power factor . . . . .	78	Friction-drive dial . . . . .	152, 154
radio-frequency . . . . .	80	Galvanometer, direct-current . . . . .	135
resistance . . . . .	76, 84, 90	Generator, standard-signal . . . . .	96
skeleton-type . . . . .	90	test-signal . . . . .	98
transformer . . . . .	92	Harmonic analyzer . . . . .	107
universal . . . . .	86	Heterodyne detector . . . . .	45
vacuum-tube . . . . .	88	frequency meter . . . . .	45, 48
Cable, shielded . . . . .	159	Hummer, microphone . . . . .	137
Calibrated condenser . . . . .	30-40	Impedance bridge . . . . .	76
inductor . . . . .	41, 42	Incremental-pitch condenser . . . . .	65
resistor . . . . .	12-27	Indicator, power-level . . . . .	120
Camera assembly . . . . .	104-106	Inductance bridge . . . . .	76, 83
Capacitance bridge . . . . .	78	standard . . . . .	41
Cathode-ray oscillograph . . . . .	102	Inductor form . . . . .	151
tube . . . . .	103	plug-in . . . . .	151
Choke, radio-frequency . . . . .	159	variable . . . . .	42
Clock, synchro . . . . .	56	Interpolation equipment . . . . .	45
Color comparator . . . . .	5	oscillator . . . . .	45
Compensated decade-resistance unit . . . . .	17	Jack base . . . . .	159
decade resistor . . . . .	12, 14	Jacks . . . . .	158
slide-wire resistor . . . . .	18	Knob, fluted . . . . .	155
Condenser, air dielectric . . . . .	30-35	Lens, dial . . . . .	151
decade . . . . .	39, 40	Lock, dial . . . . .	151
fixed . . . . .	36, 37	Logarithmic resistor . . . . .	19
incremental-pitch . . . . .	65	Low-frequency oscillator . . . . .	66
precision . . . . .	30	Megohm meter . . . . .	84, 119
standard . . . . .	30, 36	Meter, alternating-current . . . . .	122
straight-line-frequency . . . . .	33	audio frequency . . . . .	54, 55
two-section . . . . .	133	direct-current . . . . .	135
Contactors, Edgerton stroboscope . . . . .	4	distortion and noise . . . . .	111
Contacts, switch . . . . .	156	electronic frequency . . . . .	55
Copper-oxide rectifier . . . . .	134	frequency-deviation . . . . .	47
voltmeter . . . . .	122	heterodyne frequency . . . . .	45, 48
Coupling panel . . . . .	45	megohm . . . . .	84, 119
Decade bridge . . . . .	86	modulation . . . . .	110
condenser . . . . .	39	noise . . . . .	6
-condenser unit . . . . .	40	output . . . . .	122
-resistance box . . . . .	12		
-resistance unit . . . . .	14		
voltage divider . . . . .	21		
Detector, heterodyne . . . . .	45		



## INDEX BY TITLE (continued)

	<i>Page</i>		<i>Page</i>
Meter, output power . . . . .	121	Resistor, calibrated . . . . .	12-27
oxide-rectifier . . . . .	122	compensated decade . . . . .	16
sound level . . . . .	6	compensated slide-wire . . . . .	18
thermocouple . . . . .	135	decade . . . . .	12
Microphone hummer . . . . .	137	fixed . . . . .	22, 23
mixing control . . . . .	24	heavy-duty . . . . .	23
transformer . . . . .	138	logarithmic . . . . .	19
Microvolter . . . . .	117	standard . . . . .	22
Modulated oscillator . . . . .	69	Rheostat-potentiometer . . . . .	127-131
Modulation meter . . . . .	110	Selective amplifier . . . . .	45
Monitor, frequency . . . . .	47	Shielded conductor . . . . .	159
modulation . . . . .	110	transformer . . . . .	91
Mounted rheostat-potentiometer . . . . .	27	Signal generator . . . . .	96, 98
Mounting base . . . . .	159	Slide-wire resistor . . . . .	87
Multivibrator . . . . .	46	compensated . . . . .	18
Mutual inductance standard . . . . .	42	Sound level meter . . . . .	6
Network, attenuation . . . . .	20	Standard condenser . . . . .	36
Noise meter . . . . .	6	-frequency assembly . . . . .	44
Oscillator, audio . . . . .	62-68, 137	inductance . . . . .	41
beat-frequency . . . . .	62, 64	mutual inductance . . . . .	42
interpolation . . . . .	45	resistor . . . . .	22
low-frequency . . . . .	66	-signal generator . . . . .	96
modulated . . . . .	69	Stroboscope, Edgerton . . . . .	1
piezo-electric . . . . .	44, 46, 47, 48	Strobotac . . . . .	3
radio-frequency . . . . .	69	Switch contacts and stops . . . . .	156
tuning-fork . . . . .	53, 68	Switch knob . . . . .	155
Oscillograph amplifier . . . . .	73	Switches . . . . .	156
camera . . . . .	105	Synchronous-motor contactor . . . . .	4
cathode-ray . . . . .	102	Synchro-clock . . . . .	56
electron . . . . .	102	Temperature-control box . . . . .	52
Output meter . . . . .	122	Test-signal generator . . . . .	98
power meter . . . . .	121	Thermocouple, vacuum . . . . .	136
Oxide rectifier . . . . .	134	Transformer, adjustable (Variac) . . . . .	8-10
Panel, blank . . . . .	147	audio-frequency . . . . .	138-145
terminal insulator . . . . .	159	bridge . . . . .	87, 91, 144
unit . . . . .	147	shielded . . . . .	91
Piezo-electric oscillator . . . . .	44, 46, 48	variable . . . . .	144
Plate, quartz . . . . .	50	Transmission monitoring assembly . . . . .	109
Plugs . . . . .	158	Transmitting inductor . . . . .	151
Potentiometers, mounted . . . . .	27	Unit-panel equipment . . . . .	147-150
unmounted . . . . .	127-131	Universal bridge . . . . .	86
Power-level indicator . . . . .	120	rack . . . . .	147
meter, output . . . . .	121	Vacuum-tube bridge . . . . .	88
supply . . . . .	123, 124	voltmeter . . . . .	116
Precision condenser . . . . .	30	Variable air condenser . . . . .	30-35
dial . . . . .	152	inductor . . . . .	42
fork . . . . .	53	transformer . . . . .	144
wavemeter . . . . .	57	Variac . . . . .	8-10
Primary standard of frequency . . . . .	44	Variometer . . . . .	42
Quartz bars . . . . .	51	Voltage divider . . . . .	131
plate . . . . .	50	decade . . . . .	21
Rack, relay . . . . .	146, 147	Voltmeter, oxide-rectifier . . . . .	122
Radio-frequency bridge . . . . .	80	vacuum-tube . . . . .	116
choke . . . . .	159	Volume control . . . . .	24, 25, 26
oscillator . . . . .	69	indicator . . . . .	120
Ratio-arm box . . . . .	92	Wave analyzer . . . . .	107
Rectifier, oxide . . . . .	134	filter . . . . .	113, 114
laboratory . . . . .	123, 124	Wavemeter . . . . .	57-60
Rectifier-type wavemeter . . . . .	59	precision . . . . .	57
Relay rack . . . . .	146, 147	rectifier-type . . . . .	59
Resistance box, decade . . . . .	12		
bridge . . . . .	76, 84		
unit, compensated decade . . . . .	17		
unit, decade . . . . .	14		

# QUICK INDEX

iv	HOW TO ORDER
2	INDUSTRIAL DEVICES
12	RESISTORS
30	CONDENSERS
42	INDUCTORS
44	FREQUENCY- AND TIME-MEASURING DEVICES
62	OSCILLATORS
72	AMPLIFIERS
76	BRIDGES AND ACCESSORIES
96	STANDARD-SIGNAL GENERATORS
102	OSCILLOGRAPHS, CAMERAS, AND ANALYZERS
116	METERS
124	POWER SUPPLIES
126	PARTS AND ACCESSORIES
160	APPENDIX AND DATA TABLES
168	INDEX BY TYPE NUMBER
170	INDEX BY TITLE

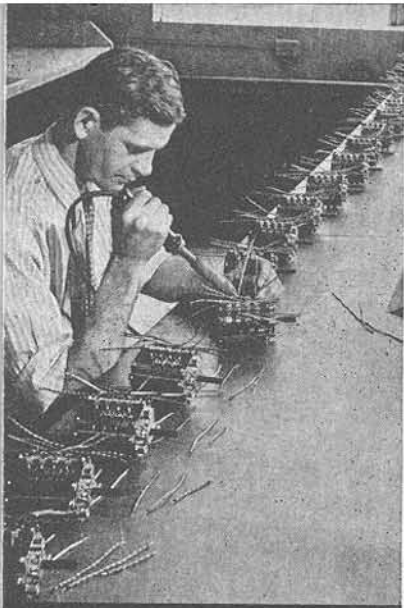

19 - WIRING FREQUENCY-CHANGE SWITCHES

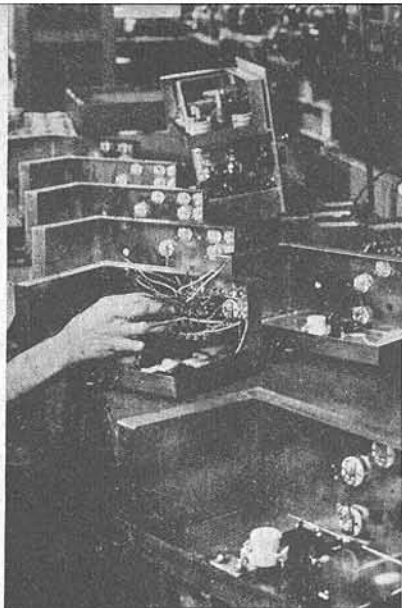

20 - ASSEMBLING OSCILLATOR SHELVES.



21 - ASSEMBLING OSCILLATOR TUNING CONDENSES



22 - FINAL OSCILLATOR ASSEMBLY

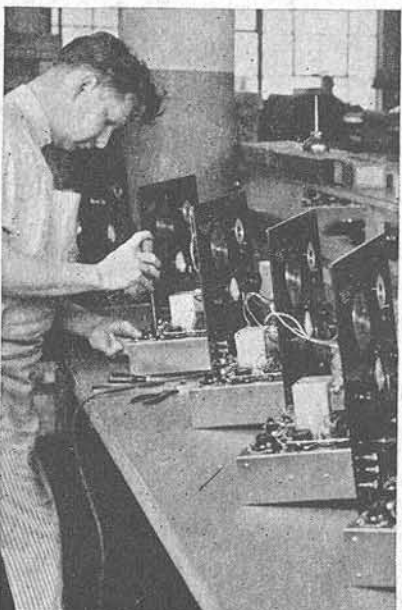

23 - MAIN ASSEMBLY



23a - MAIN ASSEMBLY



24 - COPPER LINING CABINET



25 - CALIBRATION OF COMPLETED INSTRUMENT



26 - SEALING CASES



